

Instruction Manual

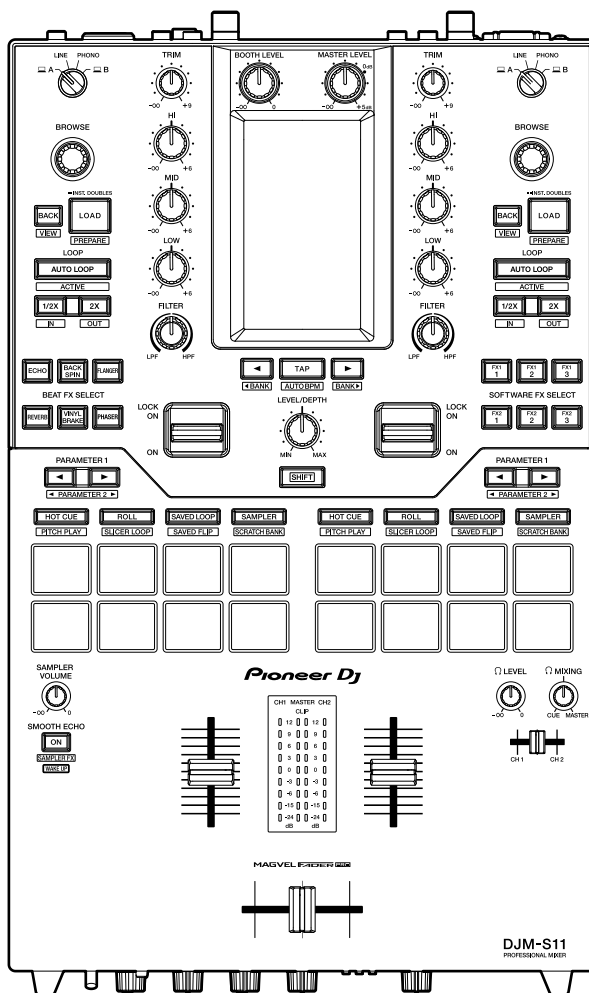

DJ Mixer

DJM-S11

pioneerdj.com/support/

rekordbox.com

<http://serato.com/>

For FAQs and other support information for this product, visit the websites above.

Pioneer Dj

serato

Contents

Before you start	6
How to read this manual	6
What's in the box.....	7
User guides	7
DJ software	8
Serato DJ Pro.....	8
rekordbox	9
Part names	10
Top panel	10
Front panel.....	11
Rear panel.....	12
Touch screen	14
PC/Mac setup	17
Dedicated software	17
Setting Utility	19
Connections	26
Connecting to the input terminals.....	26
Connecting to the output terminals	27
Connecting to the CDJ/controller terminals.....	28
DVS	29
Connections	29
Settings in Serato DJ Pro.....	31
Playback	34
Browse section.....	34
Browse screen	35
Adding a track to the library	36

Loading a track to the unit.....	37
Playing a track.....	37
Audio output	38
Channel section/master section	38
Outputting sound	40
Adjusting the sound.....	41
Setting the faders	41
Monitoring sound	44
Headphones section	44
Monitoring with headphones	44
Booth section	45
Using a booth monitor	45
Microphone	46
MIC section	46
Using a microphone	47
Using the microphone echo	48
AUX.....	49
AUX section	49
Using AUX.....	49
Filter	50
Filter section	50
Using a filter or an effect	50
Effect types and settings	51
Beat FX/software FX.....	53
FX section	53
Using Beat FX/software FX.....	54
Beat FX types and settings	55
Using Touch FX	62
Using FX Bank	63

Using FX Trigger mode	67
Smooth Echo.....	68
Smooth Echo section	68
Using Smooth Echo	68
Loop.....	71
Loop section	71
Using a loop	72
Using the Performance Pads.....	73
Performance Pad section	73
Serato DJ Pro.....	74
rekordbox	89
User mode	96
Using User modes.....	96
Fader Start.....	98
Using Fader Start	98
Deck 3/deck 4.....	100
Using deck 3/deck 4.....	100
Touch MIDI	103
Using Touch MIDI	103
Settings.....	104
Changing the settings	104
Utility settings	105
Replacing the bumper for the crossfader	112
Specifications	119
Block diagram	122
Additional information	123
Troubleshooting	123
LCD display.....	123
Trademarks and registered trademarks	124

Software license notice	125
Cautions on copyrights.....	126

Before you start

How to read this manual

- Thank you for choosing this Pioneer DJ product.
Be sure to read this manual, the “Quick Start Guide” and the “Precautions for Use” which are also included with this product. These documents include important information that you should understand before using the unit. In particular, be sure to read the IMPORTANT SAFETY INSTRUCTIONS.
- In this manual the names of buttons, knobs and terminals that appear on the product, and the names of buttons, menus etc. in the software on your PC/Mac or mobile device, are indicated within square brackets ([]). (e.g. **[File]**, **[CUE]** button)
- Please note that the software screens and their specifications, as well as the external appearance and specifications of the hardware, were still under development at the time this manual was created and may differ from the final specifications.
- Please note that depending on the operating system version, web browser settings, etc. operation may differ from the ways described in this manual.
- Please note that the language on the screens of the software described in this manual may differ from the language on your screen.

What's in the box

- Power cord
- USB cable^{*1}
- Fader bumper A × 4^{*2}
- Fader bumper B × 2^{*2}
- Warranty (for some regions)^{*3}
- Quick Start Guide
- Precautions for Use
- Serato DJ Pro Expansion Pack voucher^{*4}

*1 One USB cable is included with the unit. To connect two devices to the unit, use an additional cable that conforms to USB 2.0 standards.

*2 Included inside the unit's panel. For details on removing the panel, see Replacing the bumper for the crossfader (page 112).

*3 Only products in Europe.

Products in North America and Japan include warranty information in the "Precautions for Use".

*4 The voucher code needed to activate the expansion pack can't be reissued. Keep it in a safe place to be sure you don't lose it.

User guides

❖ Serato DJ Pro software manual

Refer to the following Serato DJ site.

<https://serato.com/dj/pro/downloads>

❖ rekordbox Introduction, Instruction Manual

Refer to the "rekordbox Introduction" to find out how to set up rekordbox, and see the "Instruction Manual" to find out how to use rekordbox.

Visit the URL below to find these user guides.

rekordbox.com/manual

DJ software

You can DJ with this unit by connecting it to a PC/Mac running Serato DJ Pro or rekordbox.

Serato DJ Pro

Serato DJ Pro is DJ software from Serato and compatible with DVS (page 29).

The Serato DJ Pro software is not included with the unit. Download the software from the URL below.

<http://serato.com/>

- For the latest system requirements, compatibility, and supported operating systems, visit the URL below.

<https://serato.com/dj/pro/downloads>

- Operation is not guaranteed on all PC/Mac models, even if the system requirements are met.
- Your PC/Mac may not provide sufficient processing capabilities for the CPU and hard disk, depending on its power-saving settings and some other conditions. For laptops in particular, use the High Performance setting, e.g. keep the AC power connected when using Serato DJ Pro.

rekordbox

rekordbox is a professional DJ application for music management and performing.

The rekordbox software is not included with the unit. Download the software from the URL below.

rekordbox.com/system

- The unit is automatically recognized when you launch rekordbox, and the following functions will be available.
 - Performance mode (the DJ functions in rekordbox)
 - DVS (digital vinyl system), which controls decks using the signals from compatible multi players, or from turntables when using the dedicated control vinyl.
- For the latest system requirements, compatibility, and supported operating systems, visit the URL below.

rekordbox.com/system

- Operation is not guaranteed on all PC/Mac models, even if the system requirements are met.
- Your PC/Mac may not provide sufficient processing capabilities for the CPU and hard disk, depending on its power-saving settings and some other conditions. For laptops in particular, use the High Performance setting, e.g. keep the AC power connected when using rekordbox.

Part names

Top panel

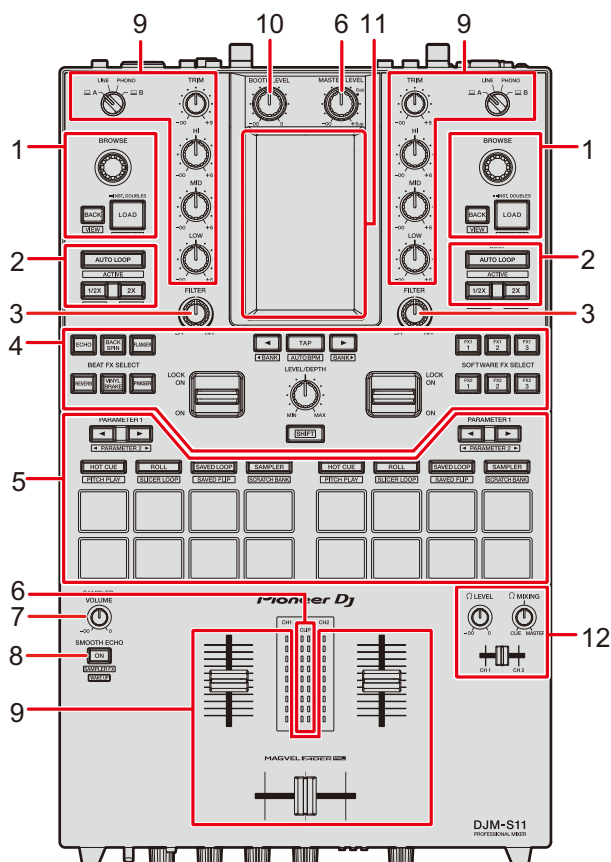

1. **Browse section** (page 34)
2. **Loop section** (page 71)
3. **Filter section** (page 50)
4. **FX section** (page 53)
5. **Performance Pad section** (page 73)
6. **Master section** (page 38)
7. **Sampler Volume knob** (pages 78, 92)
8. **Smooth Echo section** (page 68)
9. **Channel section** (page 38)
10. **Booth section** (page 45)

11. **Touch screen** (page 14)
12. **Headphones section** (page 44)

Front panel

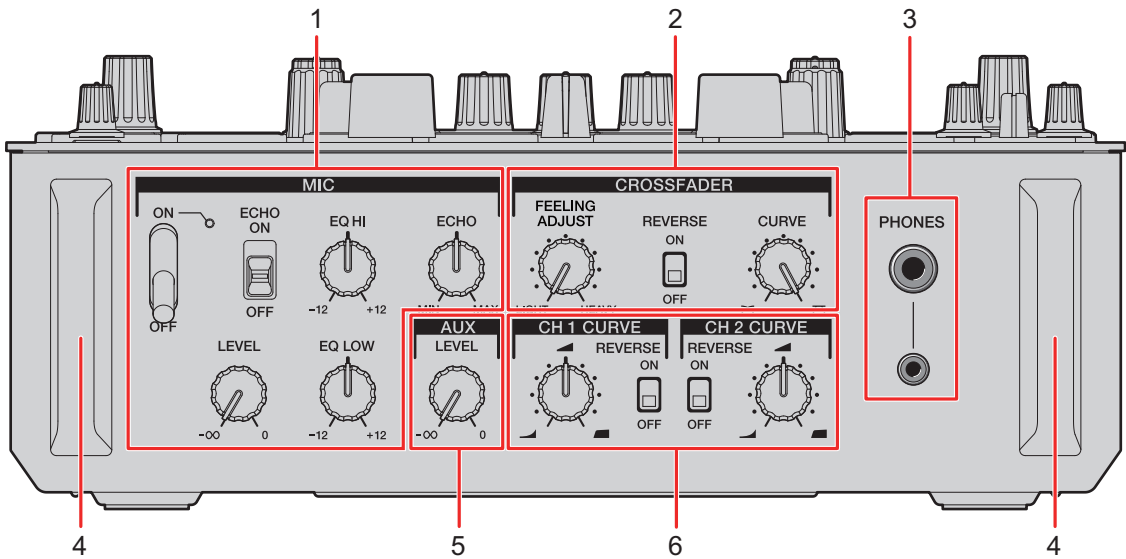

1. **MIC section** (page 46)
2. **Crossfader section** (page 42)
3. **PHONES terminals** (page 44)
4. **Front guard**
Protects the terminals and knobs on the front panel.
 - Do not stand the unit on the guards as if they're feet, or it may tip over.
5. **AUX section** (page 49)
6. **Channel curve section** (page 41)

Rear panel

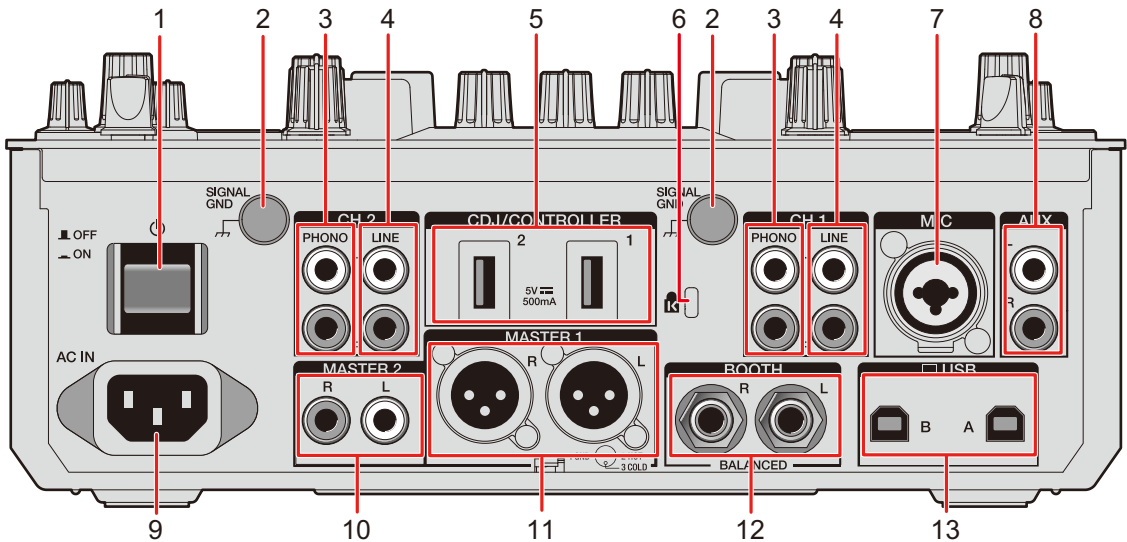

1. ⏻ button

Turns the unit on and off.

2. **Signal GND terminal** (page 26)

Connect a turntable's ground wire.

Reduces unwanted noises that occur when a turntable is connected to the unit.

3. **PHONO terminals (RCA)** (page 26)

Connect phono-level (MM cartridge) output devices.

- Do not input line-level signals to the terminals.
- Remove the short-circuit pin plugs from the terminals when connecting devices. When you are not using the terminals, attach the short-circuit pin plugs to cut out external noises.

⚠ WARNING

Keep the short-circuit pin plugs out of the reach of children and infants. If accidentally swallowed, contact a doctor immediately.

4. **LINE terminals (RCA)** (page 26)

Connect multi players or line-level output devices.

5. **CDJ/CONTROLLER terminals** (page 28)

Connect compatible multi players or controllers.

- Do not connect storage devices (e.g. USB drives/hard disks, etc.) to the [**CDJ/CONTROLLER**] terminals.

Note that, if you turn the input selector switches, devices are forcibly disconnected from any PC/Mac connected to the unit and data on the devices may break.

6. **Kensington security slot**

Connect a cable lock.

7. **MIC terminal (XLR or 1/4"/6.35 mm, TRS)** (page 26)

8. **AUX terminals** (page 26)

Connect a line-level input device.

9. **AC IN** (page 26)

Connect to a power outlet with the supplied power cord.

10. **MASTER 2 terminals (RCA)** (page 27)

Connect to analog input terminals on a power amplifier, etc.

11. **MASTER 1 terminals (balanced XLR)** (page 27)

Connect to analog input terminals on a power amplifier, etc.

- Use the terminals for balanced output only.
- Do not connect a power cord from another product to the terminals.
- Do not connect to a terminal that can supply phantom power.

12. **BOOTH terminals (1/4"/6.35 mm, TRS)** (page 27)

Connect a booth monitor.

- Use the terminals for balanced output only.

13. **USB ports** (page 26)

Connect a PC/Mac.

Touch screen

Waveform screen

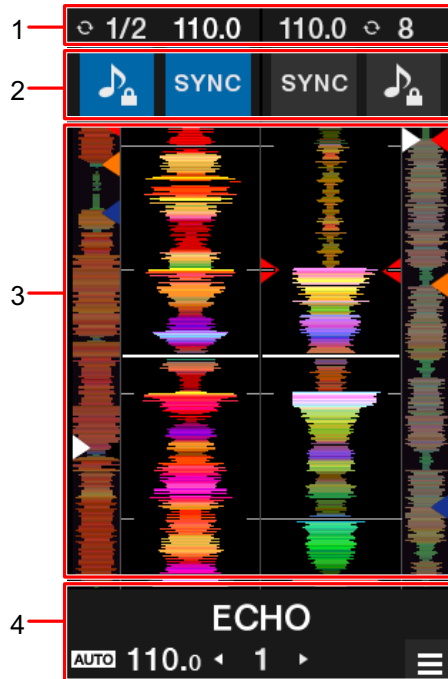

1. Information display

Displays BPM and the number of beats for a loop.

2. Software controls

Displays buttons that control software functions.

- : Turns the key lock function on and off.
- **[SYNC]**: Turns on the sync function that automatically synchronizes the tempo of a track to the beatgrid.
Touch while pressing the **[SHIFT]** button to turn off sync.

3. Waveform display

Displays overall waveform, detailed waveform, and Hot Cue points, etc. that have been analyzed by DJ software.

4. Effect display/MENU button

Displays the information for the selected effect.

Touch to display the **[MENU]** screen (page 15).

MENU screen

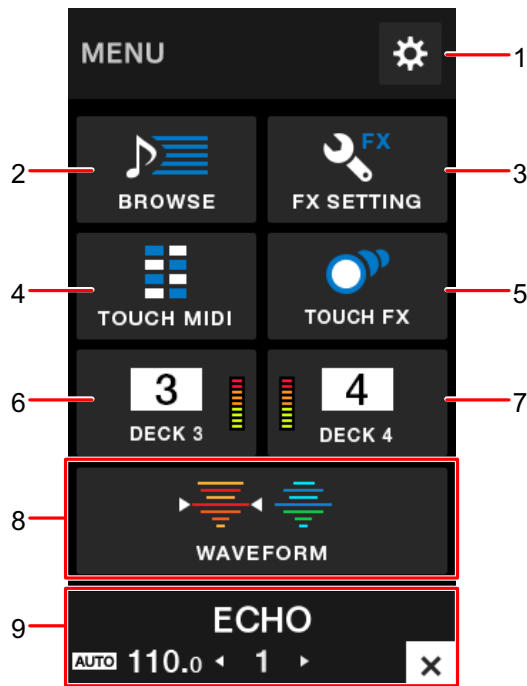

1.  (page 104)
Displays the Utility menu.
2. **BROWSE** (page 35)
Displays the browse screen.
3. **FX SETTING** (page 63)
Displays the FX screen.
4. **TOUCH MIDI** (page 103)
Displays the Touch MIDI screen.
5. **TOUCH FX** (page 62)
Displays the Touch FX screen.
6. **DECK 3** (page 100)
Displays the control screen for deck 3.
7. **DECK 4** (page 100)
Displays the control screen for deck 4.
8. **WAVEFORM** (page 14)
Displays the waveform screen.

9. Effect display/MENU button

Displays the information for the selected effect.

Touch to display the previous screen.

❖ MENU transition

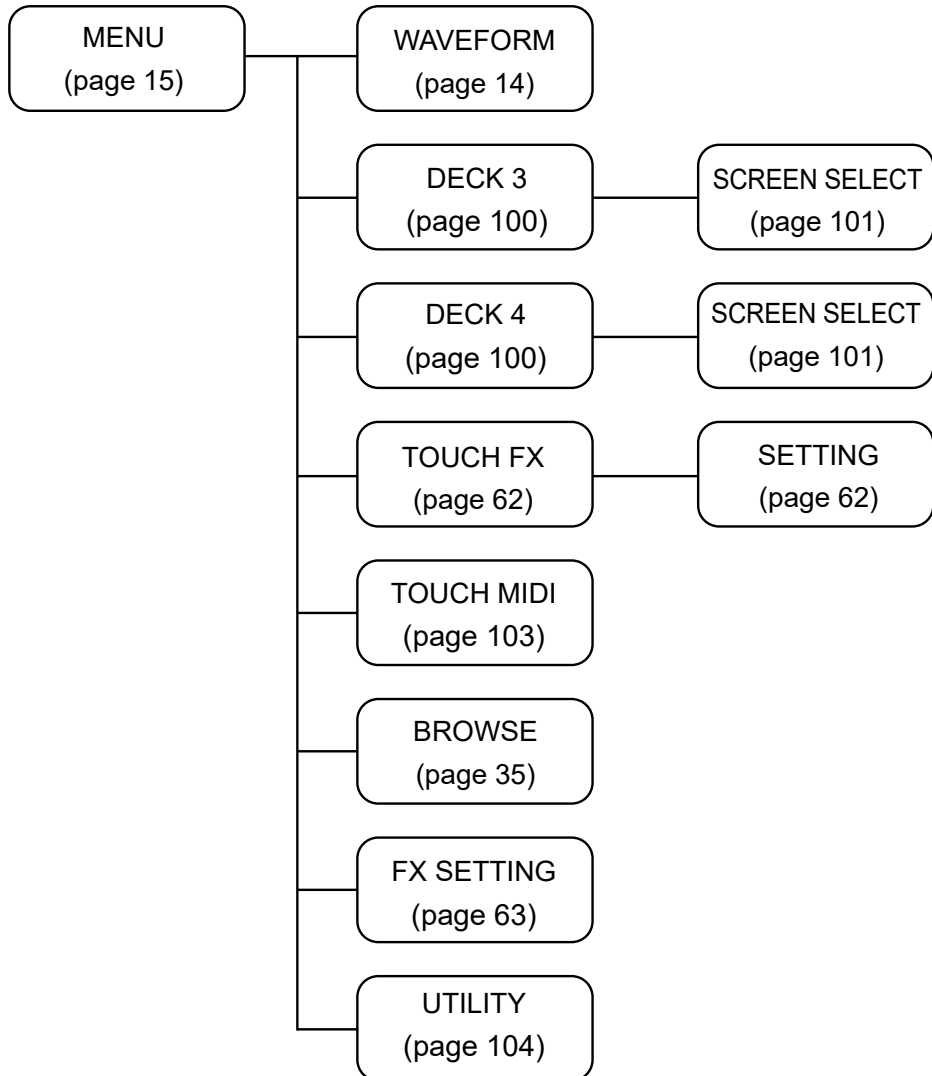

PC/Mac setup

Dedicated software

To input or output your PC/Mac's audio to/from the unit, install the dedicated audio driver software and/or Setting Utility on your computer.

If you install the audio driver software to your PC (Windows), Setting Utility will also be installed with the driver software.

If you use a Mac, install Setting Utility only.

- For the latest system requirements, compatibility, and supported operating systems, visit the URL below.

pioneerdj.com/support/

- Operation is not guaranteed on all PC/Mac models, even if the system requirements are met.
- Operation is not guaranteed when multiple units are connected to a PC/Mac.
- If a PC (Windows) without the audio driver software installed is connected to the unit, errors may occur on the PC.
- Malfunctions may occur due to incompatibility with other software installed on a PC/Mac.

Installation

❖ Notes on installation

- Turn the unit off and disconnect the USB cable connected to the unit and the PC/Mac before installation.
- Close all applications running on the PC (Windows) before installation.
- You will need admin rights to install the audio driver software to your PC (Windows).
- Read the License Agreement terms carefully before installation.
- If you quit the installation halfway through, perform the installation procedure from the beginning again.

Downloading the dedicated software

Download the dedicated audio driver software/Setting Utility to your PC/Mac from the URL below.

pioneerdj.com/support/

Installing the dedicated software

- 1 Double-click the downloaded installation file.**
- 2 Read the License Agreement terms carefully.**
If you agree to the terms, mark the [Agree] check box and click [OK].
 - If you do not agree to the License Agreement terms, click **[Disagree]** (for Mac)/**[Cancel]** (for Windows) to cancel the installation.
- 3 Follow the on-screen instructions to complete the installation.**

Setting Utility

You can check and set connections between the unit and a PC/Mac using the Setting Utility installed on the PC/Mac.

Launching Setting Utility

1 Click **[Pioneer] > [DJM-S11 Setting Utility]** from the applications list on a PC/Mac.

Setting Utility launches.

- You can also launch it from **[PC UTILITY]** in the Utility menu (page 111).

Checking the status of the input selector switches on the unit

1 Click the **[MIXER INPUT]** tab.

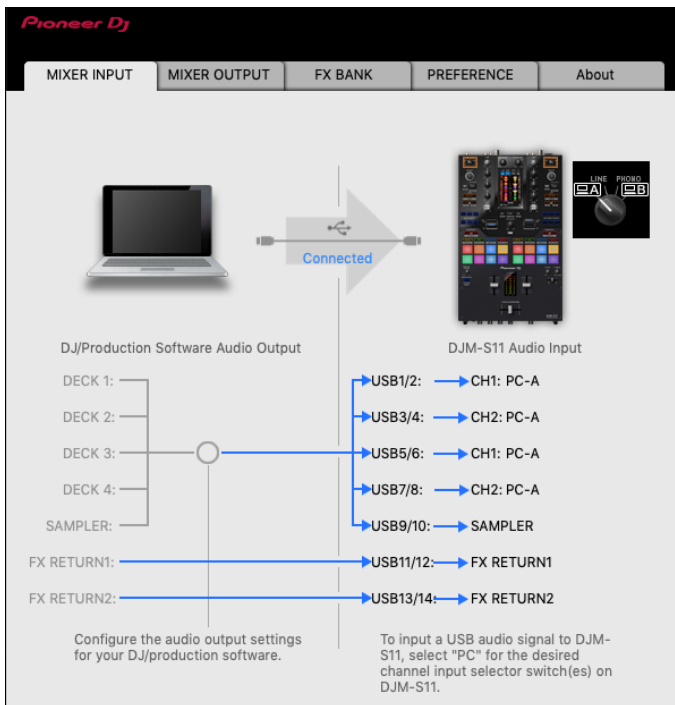

Setting the audio data output from the unit to a PC/Mac

- 1 Click the **[MIXER OUTPUT]** tab.
- 2 Click the pull-down list under **[DJM-S11 Audio Output]** and select the audio data output from the unit to the PC/Mac.

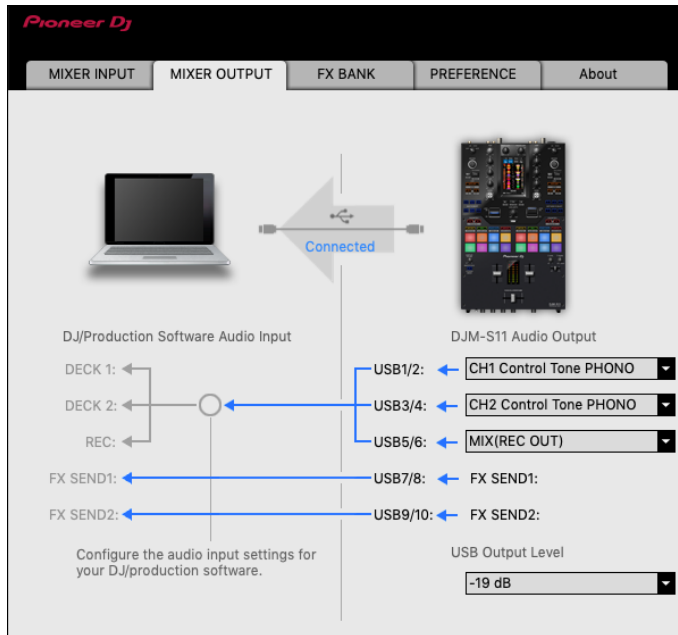

📖 Read more: Audio Output pull-down list (page 25)

- 3 Click the pull-down list under **[USB Output Level]** and select a level of volume to output from the unit.
 - Set the volume in **[USB Output Level]** when you can't produce as much volume as you expect using the volume adjustment in your DJ application. Note that the sound may be distorted if you set the volume too high.

Adjusting the buffer size (for Windows ASIO)

- Close any running applications (DJ applications, etc.) which use the unit as the default audio device before adjusting the buffer size.

1 Click the [ASIO] tab.

2 Adjust the buffer size with the slider.

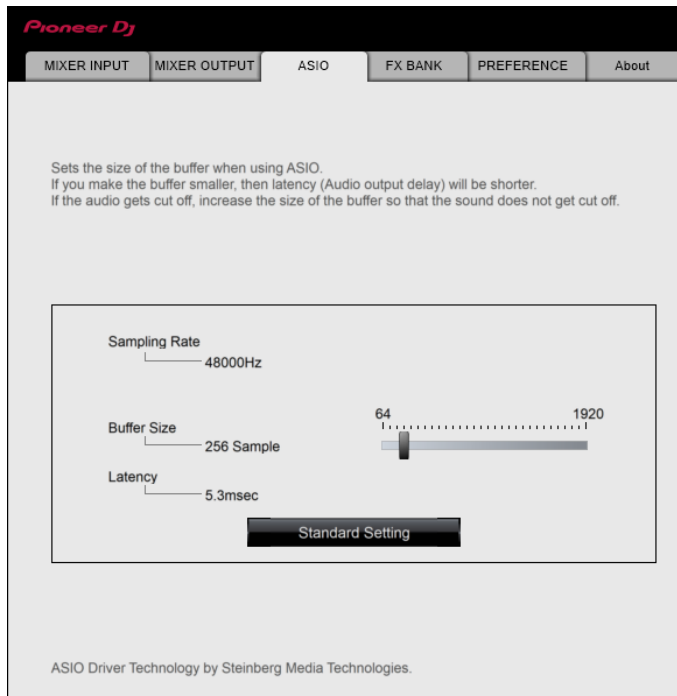

- Breaks in sound are less likely to occur if you set a large buffer size, but this increases lag time due to the latency of audio data transmission.

Changing the assignment of the FX

You can change the FX assigned to the [BEAT FX SELECT] and [SOFTWARE FX SELECT] buttons and the [FILTER] knob on the unit.

You can register the settings to [BANK A], [BANK B], [BANK C], or [BANK D], and call up the settings when you need to.

📖 Read more: Setting an FX Bank using Setting Utility (page 63)

Changing the settings

- 1 Click the [PREFERENCE] tab.
- 2 Change the settings.

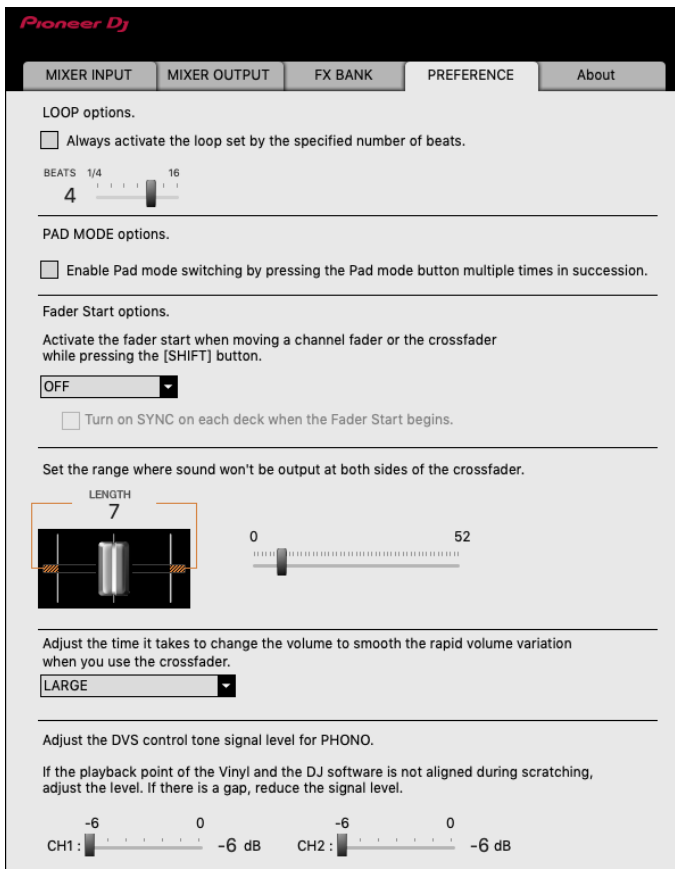

Setting items	Description
LOOP options. ¹	<p>Mark the check box to activate the loop length set by the slider.</p> <p>Clear the check box to set the [AUTO LOOP] button on the unit to work as the Auto Beat Loop button.</p>
PAD MODE options.	<p>Mark the check box to enable Pad mode switching by pressing a Pad mode button twice, three, or four times in succession.</p> <ul style="list-style-type: none"> When two computers (PC/Mac) are connected to the unit and the input selector switches for CH 1 and CH 2 are set to the different computers, this setting will be valid when it's enabled on each PC/Mac.
Fader Start options.	<p>To enable the Fader Start function, select [ON] from the pull-down list and mark the check box.</p> <p> Read more: Using Fader Start (page 98)</p>
Set the range where sound won't be output at both sides of the crossfader.	<p>Use the slider to set the range where sound will not be output at the both ends of the crossfader.</p> <ul style="list-style-type: none"> When two computers (PC/Mac) are connected to the unit and the input selector switches for CH 1 and CH 2 are set to [LINE] or [PHONO], this setting is invalid (the default setting is applied).
Adjust the time it takes to change the volume to smooth the rapid volume variation when you use the crossfader.	<p>Adjust the time it takes to change the volume to smooth the rapid variation in the volume when you use the crossfader.</p> <ul style="list-style-type: none"> When two computers (PC/Mac) are connected to the unit, [NONE] is automatically applied in the following cases. <ul style="list-style-type: none"> The input selector switches for CH 1 and CH 2 are set to different computers (PC/Mac). The input selector switches for CH 1 and CH 2 are set to [LINE] or [PHONO].

Setting items	Description
Adjust the DVS control tone signal level for PHONO.	Reduce the signal level if the playback points of the control vinyl and DJ software deviate while scratching.

Checking the firmware and software versions

1 Click the [About] tab.

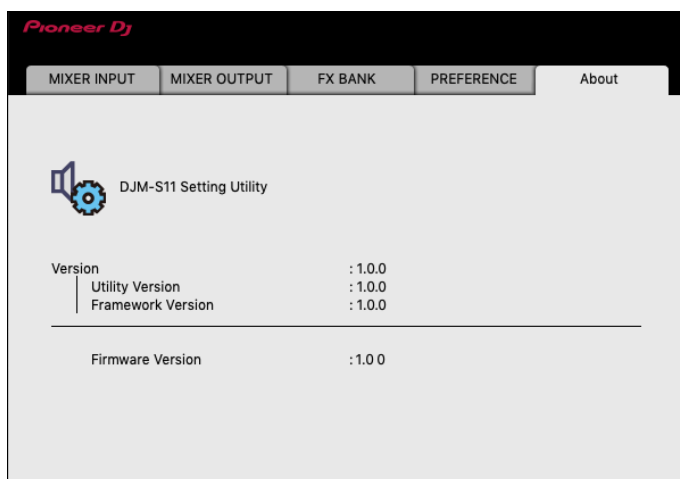

Audio Output pull-down list

- CH4 (USB 7/8), CH 5 (USB 9/10) is fixed to [FX SEND]. #: indicates channel number

CH 1 (USB 1/2), CH 2 (USB 3/4)	CH 3 (USB 5/6)
CH# Control Tone PHONO ¹	MIX(REC OUT) ² ⁴
CH# Control Tone LINE ¹	CROSSFADER A ² ³
Post CH# Fader ²	CROSSFADER B ² ³
CROSSFADER A ² ³	MIC
CROSSFADER B ² ³	AUX
MIC	Post CH1 Fader ²
AUX	Post CH2 Fader ²

- ¹ Available for software applications that support the function. Outputs sound at the volume input to the unit regardless of the [USB Output Level] setting.
- ² For uses other than recording, be sure to set the DJ application so that no sound loop occurs. Sound may be input or output at an unintended volume level when a sound loop occurs.
- ³ The sound applied with the [ECHO], [DUCKING ECHO], [ECHO OUT], [SPIRAL], or [DELAY] effect is output from [CROSSFADER A] or [CROSSFADER B].
- ⁴ The sound applied with the [REVERB] effect is output from [MIX(REC OUT)].

Connections

Turn the unit off and disconnect the power cord before connecting other units.

Connect the power cord after all the connections are complete.

- Use the supplied power cord.
- Read the instruction manuals for the devices you are going to connect with the unit.

Connecting to the input terminals

- When you use DVS (digital vinyl system) with the unit and Serato DJ Pro or rekordbox, make sure your PC/Mac is correctly connected to the input terminals on the unit and the input selector switch is correctly set.

Read the instruction manual for the software.

➡ Read more: DVS (page 29)

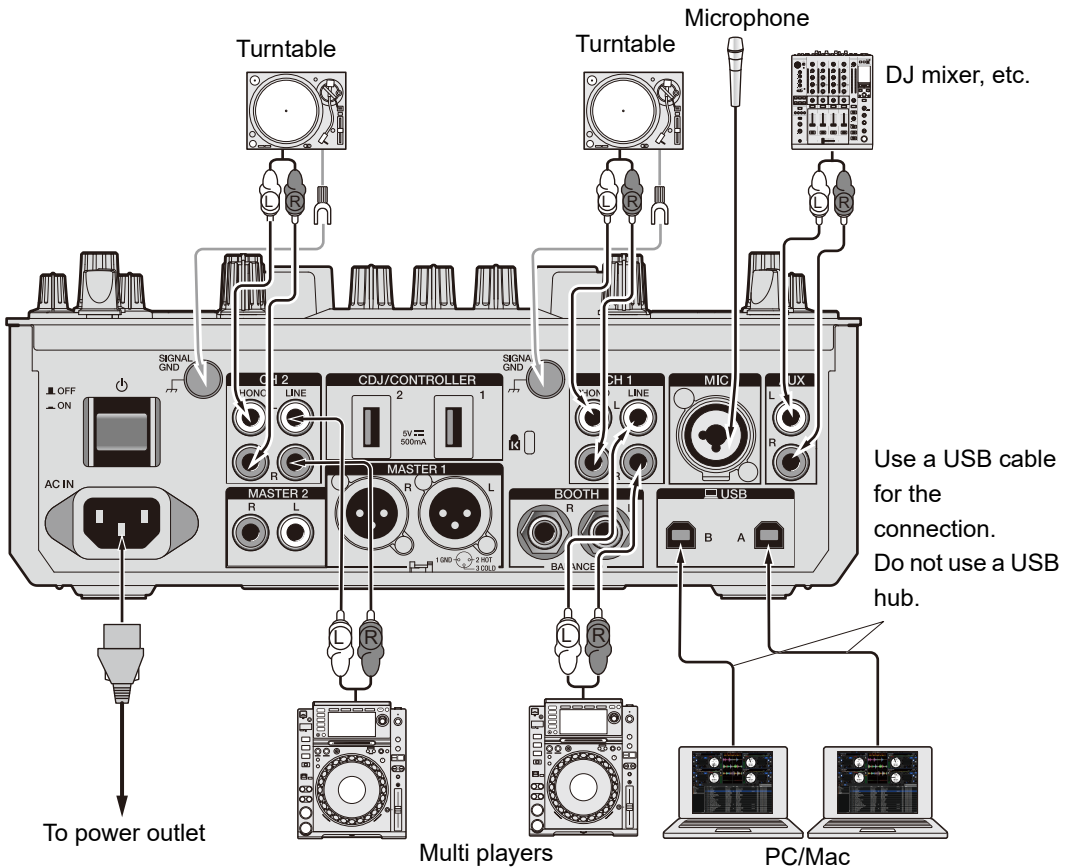

Connecting to the output terminals

Rear panel of the unit

Front panel of the unit

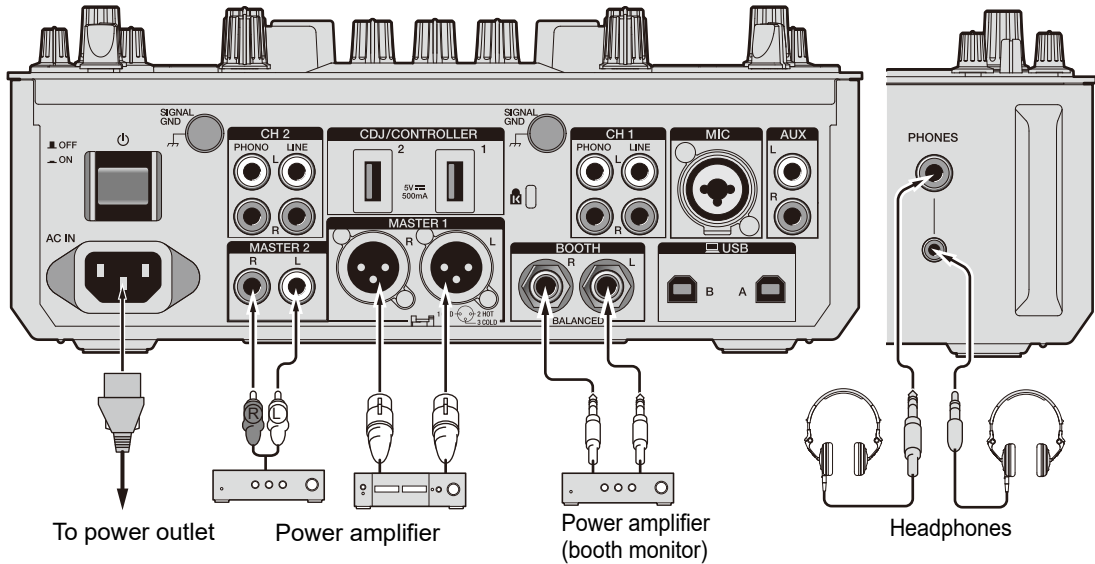

- Use the **[MASTER 1]** terminals for balanced output. Connecting the terminals to unbalanced inputs (RCA, etc.) with an XLR-RCA conversion cable (conversion adapter), etc. results in unwanted noises and/or poor sound quality.
- Use the **[MASTER 2]** terminals for unbalanced input (RCA, etc.).
- Use the **[BOOTH]** terminals for balanced output. Connecting the terminals to unbalanced inputs results in unwanted noises and/or poor sound quality.
- Do not connect a power cord from another product or a terminal that can supply phantom power to the **[MASTER 1]** terminals.

Connecting to the CDJ/controller terminals

You can control DJ software from a multi player if you connect the multi player to the [CDJ/CONTROLLER] terminals on the unit.

Be sure to read the instruction manual for the software.

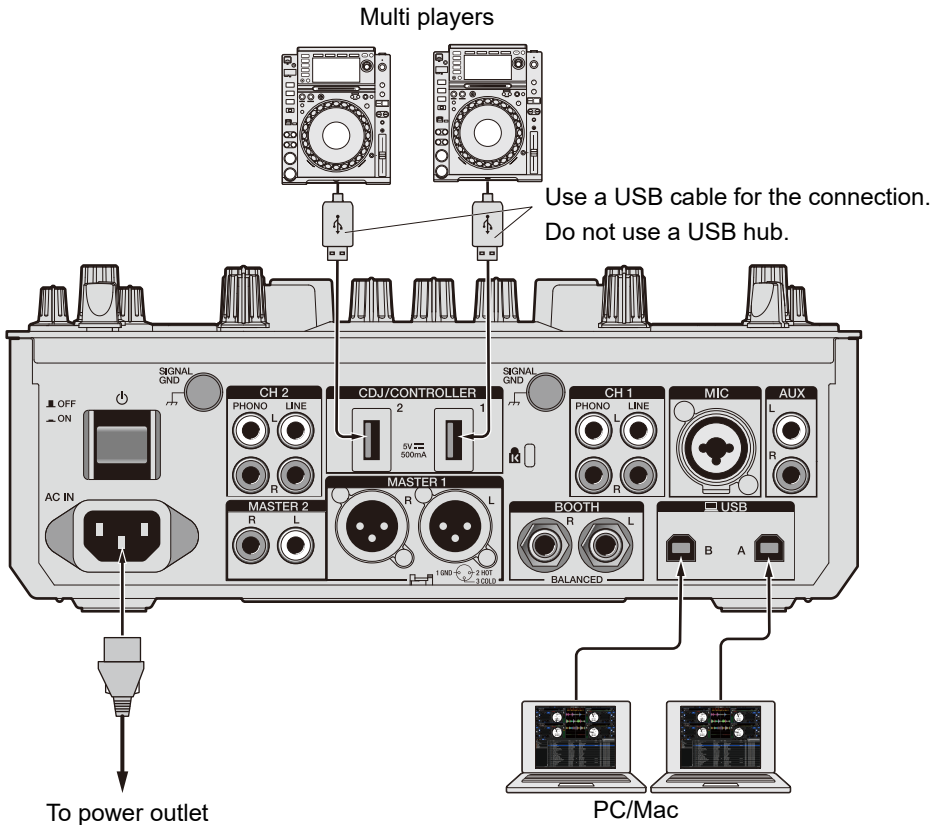

- Do not connect storage devices (e.g. USB drives/hard disks, etc.) to the [CDJ/CONTROLLER] terminals.

Note that, if you turn the input selector switches, devices are forcibly disconnected from any PC/Mac connected to the unit and data on the devices may break.

DVS

If you use the unit with DJ software (Serato DJ Pro or rekordbox) and a control disc (special vinyl or CDs with specific control signals), you can control digital music files using a turntable or multi player.

- Control discs aren't included with this unit. You'll need to buy them separately.
- You can download the control signals from the Serato DJ Pro or rekordbox website. Save them to a USB storage device to use them with this unit.
- When you use DVS with rekordbox, refer to the rekordbox dvs Setup Guide, available at the URL below.

rekordbox.com/manual

Connections

Using turntables

This section describes an example of how to connect [DECK 1] and [DECK 2] of DJ software with turntables.

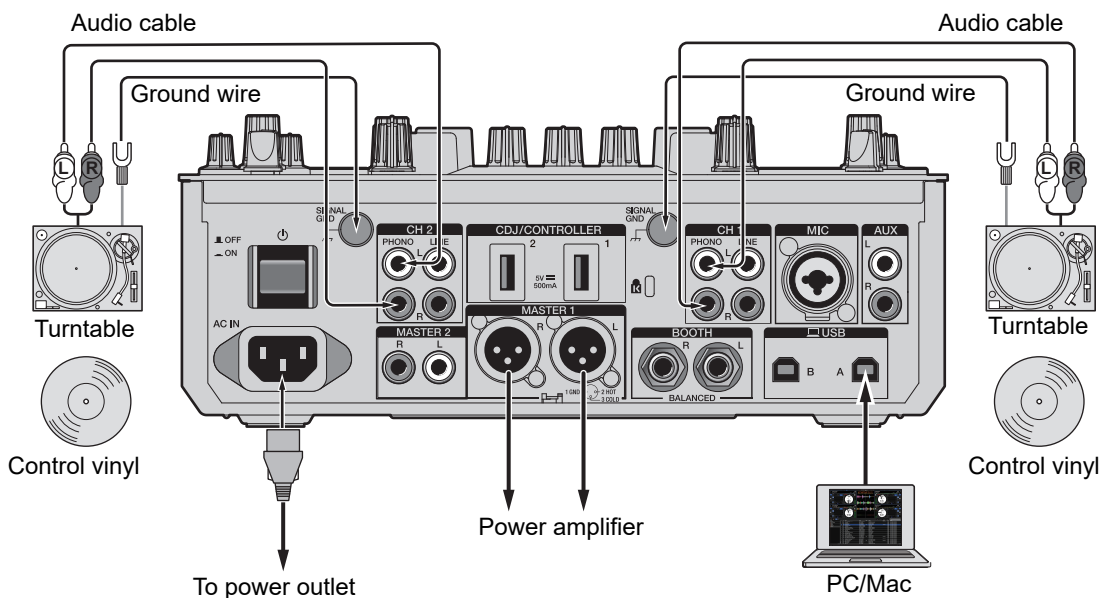

- 1 Connect a turntable you want to control [DECK 1] to the [PHONO] terminals for [CH 1], and a turntable you want to control [DECK 2] to the [PHONO] terminals for [CH 2].
- 2 Connect the turntable ground wires to the [SIGNAL GND] terminals on the unit.
- 3 Place control vinyl on the turntables.
- 4 Set the input selector switches of [CH 1] and [CH 2] on the unit to [A/B] (use [A] for the example above).

Using multi players

This section describes an example of how to connect [DECK 1] and [DECK 2] of DJ software with multi players.

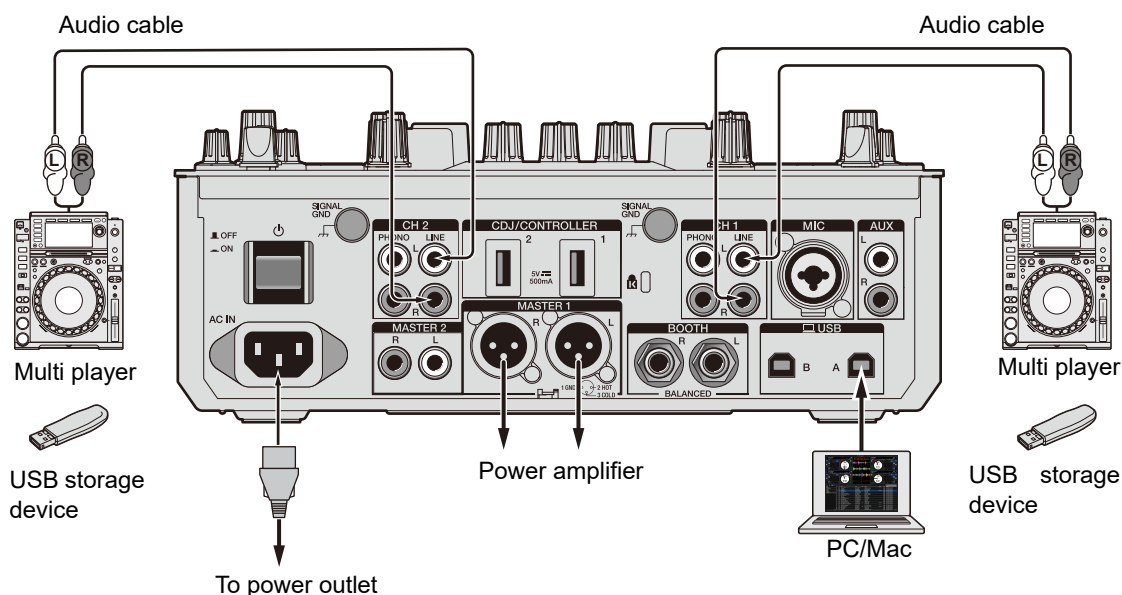

- 1 Connect a multi player you want to control [DECK 1] to the [LINE] terminals for [CH 1], and a multi player you want to control [DECK 2] to the [LINE] terminals for [CH 2].
- 2 Take USB storage devices which have the control signals saved and connect them to the multi players. Then start playback.
- 3 Set the input selector switches of [CH 1] and [CH 2] on the unit to [A/B] (use [A] for the example above).

Settings in Serato DJ Pro

SETUP screen

The SETUP screen of Serato DJ Pro is displayed as shown below when the unit is connected (the illustration shows when the unit is connected to a PC/Mac for the first time after the driver software/Setting Utility is installed).



1. **CALIBRATION DECK:** Serato DJ Pro calculates analog signals from a control disc and processes the signals for digital audio files. It calculates signal levels and device statuses for each operating environment and sets up optimal settings for reading the control signals.

If the CALIBRATION DECKS are not displayed, click the [Expansion Packs] tab, select [Vinyl/CDJ Control] from the list, and mark the check box of [Enable Vinyl/CDJ control].

Setting up Serato DJ Pro

- 1 Click **[SETUP]** on the Serato DJ Pro screen.
- 2 Select **[TURNTABLES]** or **[CDJS]** on the **[Audio]** tab of the **SETUP** screen.

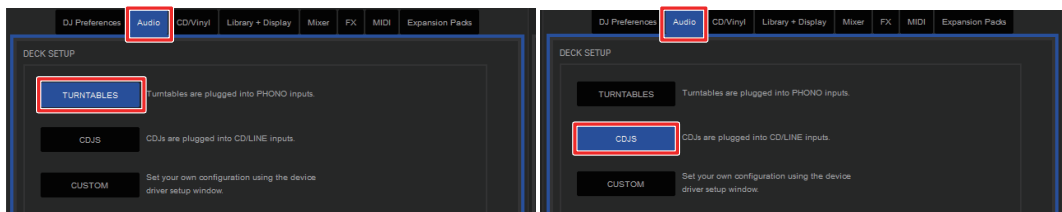

Checking control signals

- 1 Start playback of track 1 on the connected turntable or multi player.

Green rings appear on **[CALIBRATION DECK]**.

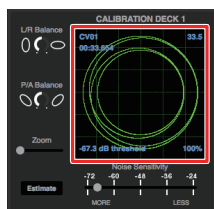

- Check if the innermost ring is almost a perfect circle. For details, refer to the Serato DJ Pro software manual (page 7).

Selecting a playback mode

Serato DJ Pro supports three playback modes ([ABS], [REL], and [INT]).

- For details on the playback modes, refer to the Serato DJ Pro software manual (page 7).

1 Select [ABS], [REL], or [INT] from the pull-down list on the deck pane.

When [ABS] is selected:

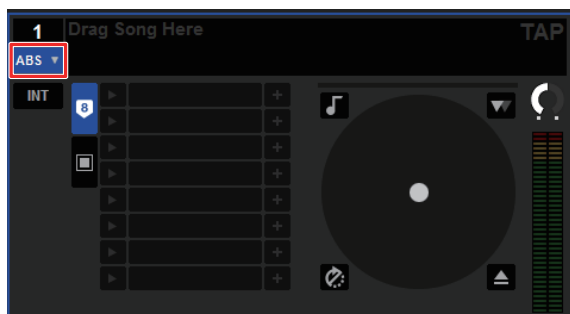

Playback

Browse section

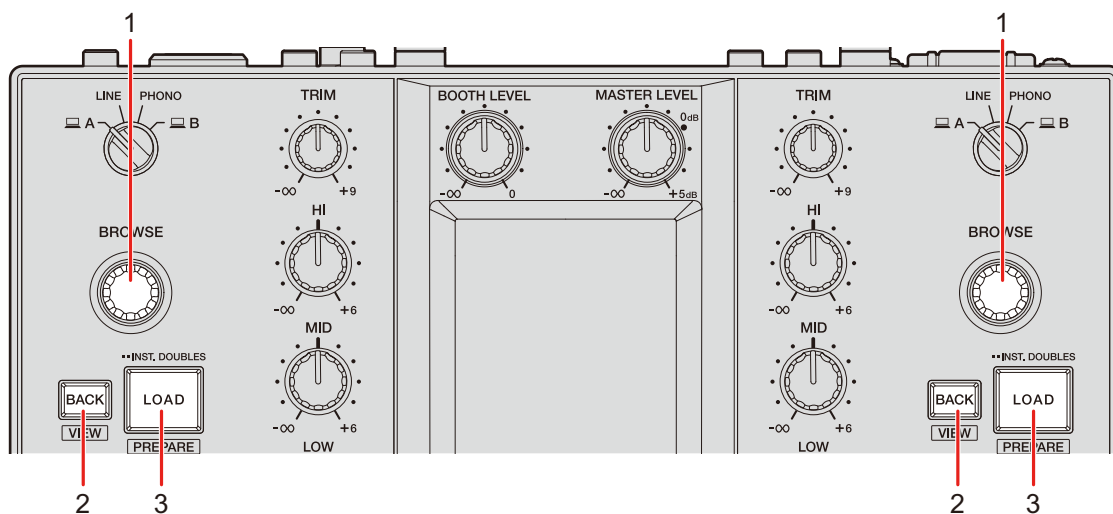

1. BROWSE knob

Displays the browse screen (page 35) if you use the knob when **[BROWSE AUTO TRANSITION]** is set to **[ON]** in the Utility settings (page 107).

Turn to move the cursor up or down.

Press to move the cursor between the crates pane and library pane on the Serato DJ Pro screen. The cursor moves to the next level down on the **[Files]** pane, and to the next category on the **[Browse]** pane.

2. BACK button

Moves the cursor between the crates pane and library pane on the Serato DJ Pro screen. Displays or hides a subcrate when a subcrate is available for the item selected on the crates pane. The cursor moves to the next level up on the **[Files]** pane, and to the previous category on the **[Browse]** pane.

Press while also pressing the **[SHIFT]** button to switch the layout of the Serato DJ Pro screen.

3. LOAD button

Loads a selected track to the unit.

Press twice to load a track that's loaded to another deck on which you're pressing the [LOAD] button. Playback starts from the same position if you press twice while playing a track and pressing the button on the other deck (Instant Doubles).

Press while pressing the [SHIFT] button to load a track to the [Prepare] pane.

Browse screen

When [BROWSE AUTO TRANSITION] is set to [ON] in the Utility settings (page 107), the browse screen is displayed if you use the [BROWSE] knob.

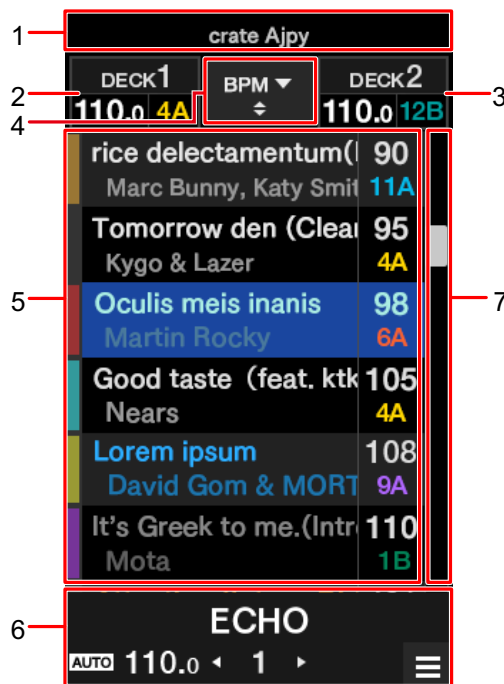

1. Higher level display

2. Deck 1 information display

3. Deck 2 information display

4. Sort button

Switches the sort item (SONG, ARTIST, BPM, KEY, or TRACK) for the library and also switches between ascending and descending orders.

5. Library display

Slide up or down to scroll the list.

Swipe a track to the left to load the track to deck 1.

Swipe a track to the right to load the track to deck 2.

6. **Effect display/MENU button**

Displays the information for the selected effect.

Touch to display the **[MENU]** screen (page 15).

7. **Quick search bar**

Slide to scroll the list quickly.

Adding a track to the library

Add a track to the library on the Serato DJ Pro screen.

1 Click [Files] on the Serato DJ Pro screen.

Files and folders stored on the PC/Mac or devices connected to the PC/Mac are displayed in the **[Files]** pane.

2 Click a folder that contains a file you want to add to the library on the [Files] pane.

The folder is selected.

3 Drag and drop the folder to the crates pane.

A crate is created and the tracks are added to the library.

Loading a track to the unit

- 1 Press the [BROWSE] knob to move the cursor to the crates pane on the Serato DJ Pro screen.**
- 2 Turn the [BROWSE] knob to select a crate, etc.**
- 3 Press the [BROWSE] knob.**

The cursor moves to the library pane.

- You can also use the [BACK] button to move the cursor between the crates pane and library pane.

- 4 Turn the [BROWSE] knob to select a track.**
- 5 Press the [LOAD] button for the deck you want to use.**

The selected track is loaded to the relevant deck.

- To load a track to deck 3 or deck 4, perform the above operations on the deck 3 and deck 4 screen (page 100).

Playing a track

- 1 Use the connected multi player, turntable, or DJ controller to start playback of a track.**

Audio output

Follow the procedures below to output and adjust sound.

- Outputting sound (page 40)
- Adjusting the sound (page 41)
- Setting the faders (page 41)

🔊 To output sound to the [BOOTH] terminals, see Using a booth monitor (page 45).

Channel section/master section

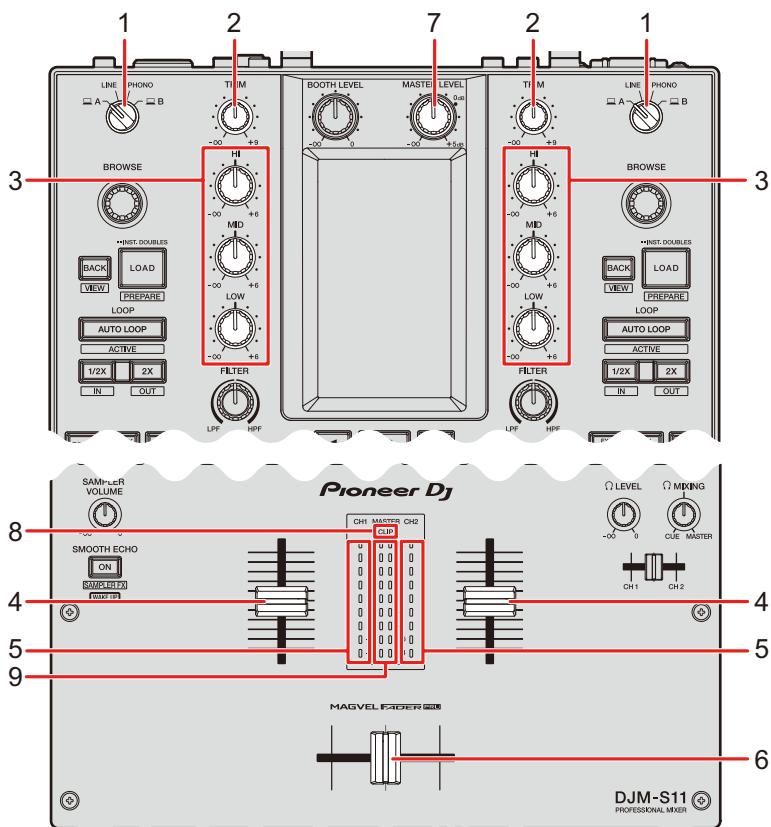

❖ Channel section

1. Input selector switch

Selects an input sound source.

- [ **A,B**]: Selects a PC/Mac connected to one of the [USB] ports.
- [LINE]: Selects a multi player, etc. connected to the [LINE] terminals.
- [PHONO]: Selects a turntable connected to the [PHONO] terminals.

2. TRIM knob

Adjusts the volume for the channel input sound.

3. HI, MID, LOW knobs

Adjusts the volume of each frequency band.

Each knob adjusts in the following range.

- [HI]: -∞ dB to +6 dB (ISO)/-26 dB to +6 dB (EQ)
- [MID]: -∞ dB to +6 dB (ISO)/-26 dB to +6 dB (EQ)
- [LOW]: -∞ dB to +6 dB (ISO)/-26 dB to +6 dB (EQ)

4. Channel fader

Adjusts the volume for the channel output sound according to the channel fader curve set with the [CH 1 CURVE] or [CH 2 CURVE] knob (page 41). Moving it up increases the volume, and down decreases the volume.

Slide up from the bottom position while pressing the [SHIFT] button to trigger Channel Fader Start (page 98).

5. Channel level indicator

Displays the volume level before the sound passes through the channel fader.

6. Crossfader

Adjusts the volume balance between the channel output sounds according to the crossfader curve specified with the [CROSSFADER CURVE] knob (page 42). Moving it to the CH 1 side outputs the sound of CH 1, and to the CH 2 side outputs the sound of CH 2.

Slide from either end to the other side while pressing the [SHIFT] button to trigger Crossfader Start (page 99).

❖ Master section

7. MASTER LEVEL knob

Adjusts the volume for the master sound.

8. CLIP indicator

Blinks when excessive volume is output from the [MASTER 1] or [MASTER 2] terminals.

9. Master level indicator

Displays the volume level of the master sound output to the [MASTER 1] and [MASTER 2] terminals.

Outputting sound

Adjusting the channel input volume

1 Turn the input selector switch to select an input sound source.

2 Turn the [TRIM] knob to adjust the volume for the input sound.

The channel level indicator lights up when sound is input to the channel.

Adjusting the channel output volume

1 Move the channel fader to adjust the volume for the output sound.

2 Move the crossfader to adjust the volume balance of the two channels.

Adjusting the master sound volume

- 1 Turn the [MASTER LEVEL] knob to adjust the volume for the master sound.

The master level indicator lights up when the master sound is output.

Adjusting the sound

- 1 Turn the [HI], [MID], and [LOW] knobs to adjust the volume of each band.

Setting the faders

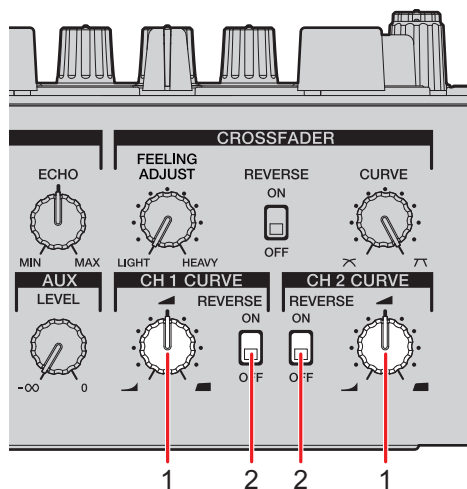

Set the channel fader and crossfader.

Channel curve section



1. CH 1/2 CURVE knob

Sets the channel fader curve.

- : Steeply raises the volume when the channel fader is moved close to the top position.
- : Gradually raises the volume as the channel fader is moved up.
- : Steeply raises the volume as the channel fader is moved from the bottom position.

2. REVERSE switch

Turns the channel fader reverse function on and off.

Setting the channel fader

1 Turn the [CH 1/2 CURVE] knob to set the channel fader curve.

- Set the [REVERSE] switch to [ON] to reverse the operating direction of the channel fader.

Crossfader section

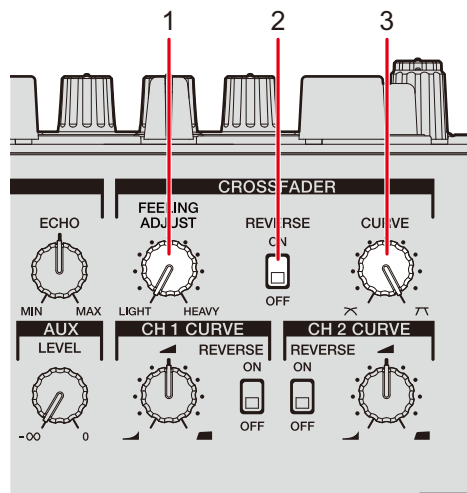

1. FEELING ADJUST knob



Adjusts the “weight” of the crossfader.

2. **REVERSE switch**

Turns the crossfader reverse function on and off.

3. **CURVE knob**

Sets the crossfader curve.

-  : Gradually raises the volume of the sound assigned to the other side as the crossfader is moved from one side (CH 1 or CH 2 side) to the other, and decreases the volume of the sound on the side it is moving away from.
-  : Steeply raises the volume of the sound assigned to the other side as the crossfader is moved from one side (CH 1 or CH 2 side) to the other.

Setting the crossfader

1 Turn the [CURVE] knob to set the crossfader curve.



2 Turn the [FEELING ADJUST] knob to adjust the “weight” of the crossfader.

- Set the [REVERSE] switch to [ON] to reverse the operating direction of the crossfader.
- You can set the cut lag (the range where sound is not output at both sides of the crossfader) in [CROSSFADER CUT LAG] in the Utility settings (page 105).

Monitoring sound

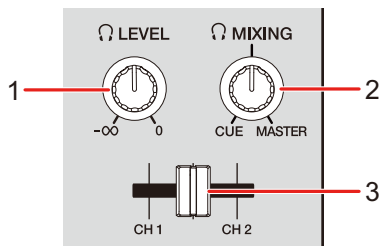
Headphones section



1.  **LEVEL knob**
Adjusts the volume for the sound output from the [PHONES] terminals.
2.  **MIXING knob**
Adjusts the volume balance between the master sound and the channel selected with the headphones cue fader.
 - Set the knob to [CUE] to monitor only the channel sound, and to [MASTER] to monitor only the master sound.
3. **Headphones cue fader**
Adjusts the volume balance between the CH 1 sound and CH 2 sound output to the headphones.

Monitoring with headphones

1 Connect headphones to one of the [PHONES] terminals.

 Read more: Connecting to the output terminals (page 27)

2 Turn the [MIXING] knob to adjust the volume balance between the channel sound and the master sound.

- 3 Move the headphones cue fader to adjust the volume balance between the CH 1 sound and the CH 2 sound.
- 4 Turn the [🎧 LEVEL] knob to adjust the volume.

Booth section

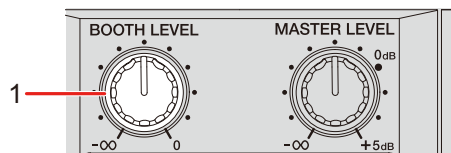

1. **BOOTH LEVEL knob**

Adjusts the volume for the sound output to a booth monitor.

Using a booth monitor

- 1 **Connect a booth monitor to the [BOOTH] terminals.**

📖 Read more: [Connecting to the output terminals \(page 27\)](#)

- 2 **Turn the [BOOTH LEVEL] knob to adjust the volume for the output sound.**

Microphone

MIC section

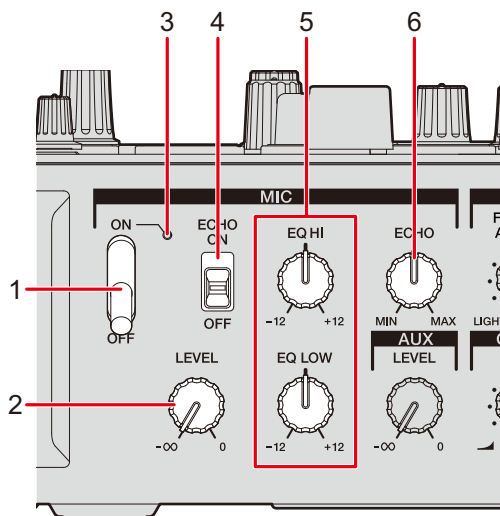

1. MIC switch

Turns the microphone on and off.

2. LEVEL knob

Adjusts the volume of sound input from the [MIC] terminal.

3. MIC indicator

Indicates the microphone sound output as follows.

- Off: The microphone is off.
- Lights up: The microphone is on.
- Blinks: The microphone is on and the microphone echo is applied.

4. ECHO switch

Turns the microphone echo on and off.

5. EQ HI, LOW knobs

Adjusts the volume of sound input from the [MIC] terminal.

Each knob adjusts in the following range.

- [EQ HI]: -12 dB to +12 dB

— [EQ LOW]: -12 dB to +12 dB

6. ECHO knob

Adjusts the volume of the echo applied to the microphone sound.

Using a microphone

1 Connect a microphone to the [MIC] terminal.

📖 Read more: Connecting to the input terminals (page 26)

2 Set the MIC switch to [ON].

3 Turn the [LEVEL] knob to adjust the microphone volume level.

- Note that turning the knob too far clockwise outputs the sound at a high volume.

4 Turn the [EQ HI] and [EQ LOW] knobs to adjust the volume of each band.

5 Speak into the microphone.

Using the microphone echo

1 Touch [FX SETTING] on the [MENU] screen.

The FX setting screen appears.

📖 Read more: MENU screen (page 15)

2 Touch [MIC ECHO].

The [MIC ECHO] screen appears.

3 Touch the number of beats you want the microphone echo to last for.

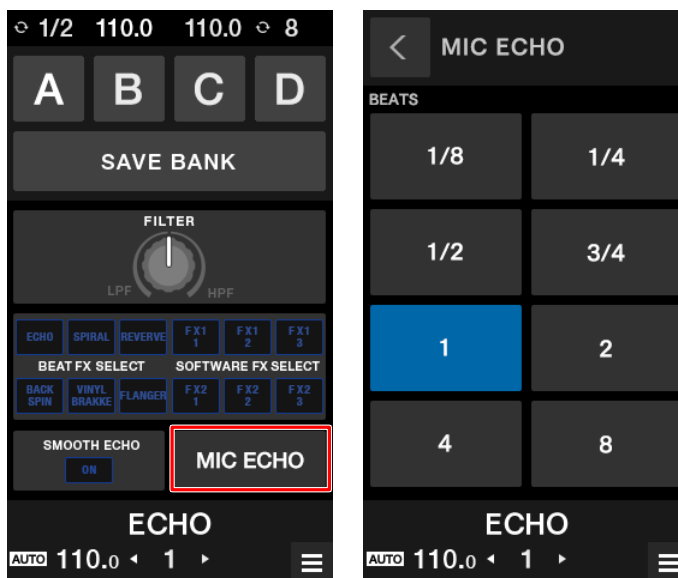

4 Turn the [ECHO] knob to adjust the echo volume.

5 Set the [ECHO] switch to [ON].

The echo effect is applied to the microphone sound according to the selected number of beats.

AUX

AUX section

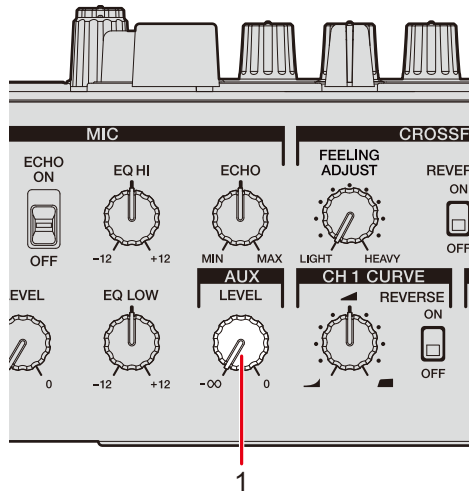

1. LEVEL knob

Adjusts the volume for the input sound from an external device.

Using AUX

1 Connect an external device to the [AUX] terminal.

➡ Read more: Connecting to the input terminals (page 26)

2 Turn the [LEVEL] knob to adjust the volume of the input sound.

Filter

You can apply a filter or an effect to the sound on any channel.

Filter section

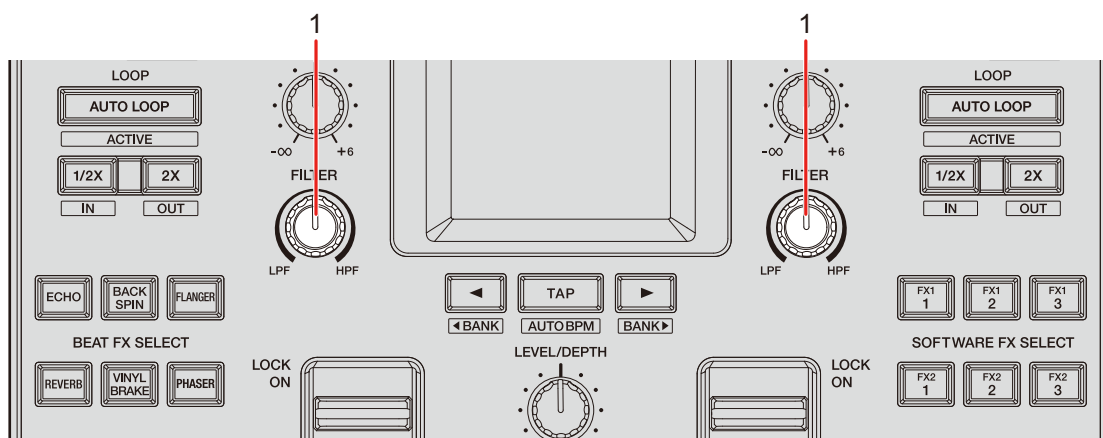

1. FILTER knob

Adjusts a filter or an effect.

Using a filter or an effect

This section describes an example of how to choose a filter or an effect from the touch screen on the unit.

You can also choose a filter or an effect from the **[FILTER]** pull-down list on the **[FX BANK]** tab in Setting Utility (page 63).

1 Touch **[FX SETTING]** on the **[MENU]** screen.

The FX setting screen appears.

➡ Read more: MENU screen (page 15)

2 Touch [FILTER].

The [FILTER] screen appears.

3 Touch an effect to use.

4 Turn the [FILTER] knob to adjust the effect.

Effect types and settings

You can adjust the following settings with the knobs or from the [FX SETTING] screen of the [MENU].

- Set the sub parameters from the [FX SETTING] screen (page 65).

Effect/operation	Description
FILTER	Outputs filtered sound.
<ul style="list-style-type: none"> • FILTER: 	Turn counterclockwise to lower the cut-off frequency of the low-pass filter. Turn clockwise to raise the cut-off frequency of the high-pass filter.
<ul style="list-style-type: none"> • Sub parameter: 	Resonance
DUB ECHO	Adds reverberating echo by outputting the sounds slightly delayed from the original sound several times and attenuating them.
<ul style="list-style-type: none"> • FILTER: 	Turn counterclockwise to add reverberating echo to the middle frequency range. Turn clockwise to add reverberating echo to the high frequency range.
<ul style="list-style-type: none"> • Sub parameter: 	Feedback

Effect/operation	Description
NOISE	Outputs filtered white noise mixed with the sound of the channel.
<ul style="list-style-type: none"> • FILTER: 	<p>Turn counterclockwise to lower the cut-off frequency for the filter which passes white noise through.</p> <p>Turn clockwise to raise the cut-off frequency for the filter which passes white noise through.</p>
<ul style="list-style-type: none"> • Sub parameter: 	Volume of the noise.
PITCH	Changes the pitch.
<ul style="list-style-type: none"> • FILTER: 	<p>Turn counterclockwise to lower the pitch.</p> <p>Turn clockwise to raise the pitch.</p>
<ul style="list-style-type: none"> • Sub parameter: 	Pitch change range: ± 1 semitone to ± 2 octaves
WIDE FILTER	Outputs filtered sound.
<ul style="list-style-type: none"> • FILTER: 	<p>Turn counterclockwise to lower the cut-off frequency for the low-pass filter.</p> <p>Turn clockwise to raise the cut-off frequency for the high-pass filter.</p> <p>Turn all the way counterclockwise or clockwise to completely cut the sound.</p>
<ul style="list-style-type: none"> • Sub parameter: 	Resonance

Beat FX/software FX

The unit includes 6 buttons for the internal effects (Beat FX) and 6 buttons for DJ software effects (software FX).

You can customize the assignment of the internal effects on the buttons.

FX section

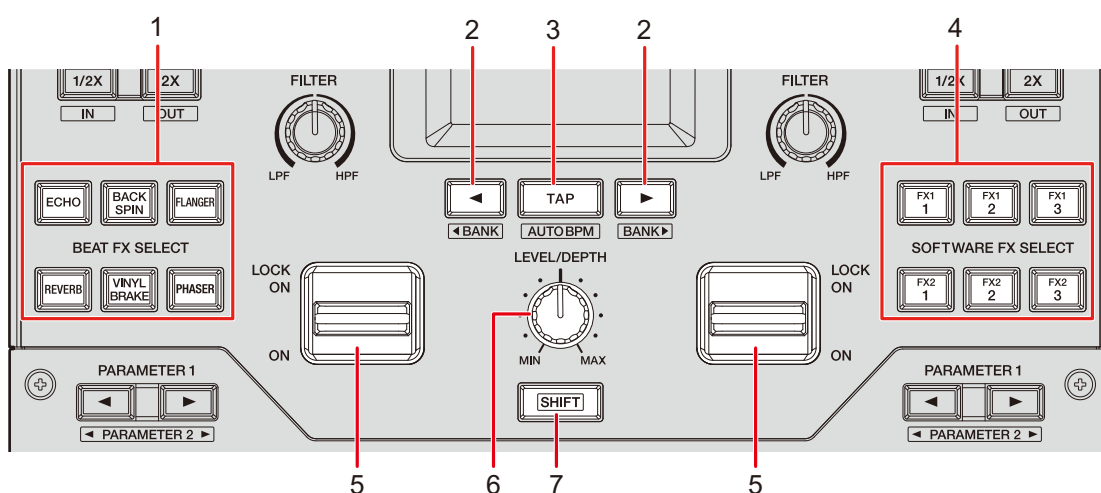

1. **BEAT FX SELECT buttons**

Selects one of the Beat FX.

2. **BEAT ◀/▶ button**

Sets the number of beats for Beat FX.

3. **TAP button**

Sets BPM.

4. **SOFTWARE FX SELECT buttons**

Selects a DJ software effect.

5. **Effect lever**

Applies an effect.

- **[ON]:** Applies an effect while you hold the effect lever in the **[ON]** position. Release the lever to return it to the center position and turn the effect off.

- **[LOCK ON]**: Continues applying an effect when you let go of the effect lever and leave it in the **[LOCK ON]** position. Return the effect lever to the center position to turn the effect off.

6. **LEVEL/DEPTH knob** (page 55)

Adjusts an effect.

7. **SHIFT button**

Using Beat FX/software FX

📖 Read more: Beat FX types and settings (page 55)

1 Press a **[BEAT FX SELECT]** or **[SOFTWARE FX SELECT]** button to which the effect you want to use is assigned.

- Press multiple **[SOFTWARE FX SELECT]** buttons to use multiple software FX at the same time.
- You can use up to 7 effects at the same time by selecting an internal effect (one of the Beat FX) and multiple software FX (up to 6 effects).
- You can change effects assigned to the **[BEAT FX SELECT]** buttons (page 63).

2 Set BPM with the **[TAP]** button.

- Press the **[TAP]** button to manually set BPM.
- Press the **[BEAT ◀]** or **[BEAT ▶]** button while pressing the **[TAP]** button to adjust BPM in increments of 1.
- Press the **[BEAT ◀]** or **[BEAT ▶]** button while pressing the **[TAP]** and **[SHIFT]** buttons to adjust BPM in increments of 0.1.
- Press the **[TAP]** button while pressing the **[SHIFT]** button to automatically set BPM.

3 Press the **[BEAT ◀]** or **[BEAT ▶]** button to set a beat fraction to synchronize the effect with.

4 Turn the **[LEVEL/DEPTH]** knob to adjust the effect.

- Turn the knob all the way counterclockwise to output the original sound.

5 Set the effect lever to [ON] or [LOCK ON].

The selected effect is applied to the sound of the channel on which you're using the effect lever.

- You can set sub parameters for Beat FX on the [MENU] screen.

Beat FX types and settings

You can adjust the following settings with the buttons and knob or from the [FX SETTING] screen of the [MENU].

- Set the sub parameters from the [FX SETTING] screen (page 65).

Beat FX/operation	Description
ECHO ¹	Outputs a delay sound several times while attenuating it according to the beat.
• BEAT ◀▶:	Delay time with respect to 1 beat of the BPM (beat fraction): 1/32 to 16 beats
• LEVEL/DEPTH :	Balance between the original sound and the effected sound, and feedback
• Sub parameter :	Cut-off frequency for HPF: 1 to 9
DUCKING ECHO ¹	Outputs a delay sound several times while attenuating it when sound is muted by the crossfader or channel fader.
• BEAT ◀▶:	Delay time with respect to 1 beat of the BPM (beat fraction): 1/32 to 16 beats
• LEVEL/DEPTH :	Balance between the original sound and the effected sound, and feedback
• Sub parameter :	Cut-off frequency for HPF: 1 to 9

Beat FX/operation	Description
ECHO OUT ¹	Mutes the input sound and outputs a delay sound several times while attenuating it.
<ul style="list-style-type: none"> • BEAT ◀/▶: • LEVEL/DEPTH: • Sub parameter: 	<p>Delay time with respect to 1 beat of the BPM (beat fraction): 1/32 to 16 beats</p> <p>Balance between the original sound and the effected sound, and feedback</p> <p>Cut-off frequency for HPF: 1 to 9</p>
SPIRAL ¹	Adds reverberation to the input sound.
<ul style="list-style-type: none"> • BEAT ◀/▶: • LEVEL/DEPTH: • Sub parameter: 	<p>Delay time with respect to 1 beat of the BPM (beat fraction): 1/16 to 16 beats</p> <p>Balance between the original sound and the effected sound, and feedback</p> <p>Speed: 1 to 9</p>
HELIX	Records the input sound and outputs the recorded sound repeatedly according to the specified beat fraction.
<ul style="list-style-type: none"> • BEAT ◀/▶: • LEVEL/DEPTH: • Sub parameter: 	<p>Effect time with respect to 1 beat of the BPM (beat fraction): 1/16 to 16 beats</p> <p>Ratio of sound overlay</p> <ul style="list-style-type: none"> • You can change the attenuation rate by turning the [LEVEL/DEPTH] knob all the way counterclockwise and then clockwise. Turn the knob all the way clockwise to fix the output sound. <p>Speed: 1 to 9</p>

Beat FX/operation	Description
DELAY ¹	Outputs a delay sound once according to the beat.
• BEAT ◀/▶:	Delay time with respect to 1 beat of the BPM (beat fraction): 1/32 to 4 beats
• LEVEL/DEPTH :	Balance between the original sound and the effected sound
• Sub parameter :	Swing: 1 to 9
REVERB ¹	Adds reverberation to the input sound.
• BEAT ◀/▶:	Reverberation level: 1 to 100%
• LEVEL/DEPTH :	Balance between the original sound and the effected sound
• Sub parameter :	Cut-off frequency for HPF: 1 to 9
BACK SPIN	Cyclically adds effect of fast reversing the input sound being played.
• BEAT ◀/▶:	Cycle of the effect with respect to 1 beat of the BPM (beat fraction): 1/16 to 64 beats
• LEVEL/DEPTH :	Balance between the original sound and the effected sound, and playback speed
• Sub parameter :	Spin speed: 1 to 9
ONE-SHOT SPIN	Adds an effect of fast reversing the input sound being played.
• BEAT ◀/▶:	Reverse playback time with respect to 1 beat of the BPM (beat fraction): 1/16 to 64 beats
• LEVEL/DEPTH :	Balance between the original sound and the effected sound, and playback speed
• Sub parameter :	Brake speed: 1 to 9

Beat FX/operation	Description
VINYL BRAKE	Cyclically slows down the playback speed of the input sound gradually according to the beat and then stops playback.
<ul style="list-style-type: none"> • BEAT ◀/▶: Cycle of the effect with respect to 1 beat of the BPM (beat fraction): 1/16 to 64 beats • LEVEL/DEPTH: Balance between the original sound and the effected sound, and playback speed • Sub parameter: Brake speed: 1 to 9 	
ONE-SHOT BRAKE	Slows down the playback speed for the input sound gradually and then stops playback.
<ul style="list-style-type: none"> • BEAT ◀/▶: Effect time with respect to 1 beat of the BPM (beat fraction): 1/16 to 64 beats • LEVEL/DEPTH: Balance between the original sound and the effected sound, and the playback speed • Sub parameter: Spin speed: 1 to 9 	
FLANGER	Adds a cyclic flanger effect according to the beat.
<ul style="list-style-type: none"> • BEAT ◀/▶: Moving cycle of the effect with respect to 1 beat of the BPM (beat fraction): 1/16 to 64 beats • LEVEL/DEPTH: Effect level • Sub parameter: Depth of flanger effect: 1 to 9 	
PHASER	Adds a cyclic phaser effect according to the beat.
<ul style="list-style-type: none"> • BEAT ◀/▶: Moving cycle of the effect with respect to 1 beat of the BPM (beat fraction): 1/16 to 64 beats • LEVEL/DEPTH: Effect level • Sub parameter: Depth of phaser effect: 1 to 9 	

Beat FX/operation	Description
HP FILTER	Cyclically changes the cut-off frequency for the high-pass filter according to the beat.
<ul style="list-style-type: none"> • BEAT ◀/▶: Moving cycle of the effect with respect to 1 beat of the BPM (beat fraction): 1/16 to 64 beats • LEVEL/DEPTH: Effect level • Sub parameter: Cycle to finely fluctuate the effect: 1 to 9 	
LP FILTER	Cyclically changes the cut-off frequency for the low-pass filter according to the beat.
<ul style="list-style-type: none"> • BEAT ◀/▶: Moving cycle of the effect with respect to 1 beat of the BPM (beat fraction): 1/16 to 64 beats • LEVEL/DEPTH: Effect level • Sub parameter: Cycle to finely fluctuate the effect: 1 to 9 	
TRANS	Cyclically cuts the sound according to the beat.
<ul style="list-style-type: none"> • BEAT ◀/▶: Cycle of the cut with respect to 1 beat of the BPM (beat fraction): 1/16 to 16 beats • LEVEL/DEPTH: Balance between the original sound and the effected sound, and duty • Sub parameter: Duty: 1 to 9 	

Beat FX/operation	Description
KILL	Attenuates the input sound gradually and then mutes the sound.
<ul style="list-style-type: none"> • BEAT ◀/▶: Attenuation time with respect to 1 beat of the BPM (beat fraction): 1/32 to 64 beats • LEVEL/DEPTH: Balance between the original sound and the effected sound, and attenuation time <ul style="list-style-type: none"> • Turn the [LEVEL/DEPTH] knob all the way clockwise to attenuate the input sound gradually and then mutes the sound according to the attenuation time specified with the [BEAT ◀] or [BEAT ▶] button. • Sub parameter: Attenuation curve: 1 to 9 	
ROLL	Records the input sound when the effect is turned on, and outputs the recorded sound repeatedly according to the specified beat fraction.
<ul style="list-style-type: none"> • BEAT ◀/▶: Effect time with respect to 1 beat of the BPM (beat fraction): 1/16 to 16 beats • LEVEL/DEPTH: Balance between the original sound and the effected sound, and mute amount • Sub parameter: Mute amount: 1 to 9 	
FADER PITCH ²	Changes the pitch of the input sound according to the operation of the channel fader.
<ul style="list-style-type: none"> • BEAT ◀/▶: Maximum pitch change (octave): -2, -1, +1, +2 • LEVEL/DEPTH: Balance between the original sound and the effected sound • Sub parameter: Scale: LINEAR, CHROMATIC, MAJOR, MINOR, MAJOR P, MINOR P, 4STEP 	

Beat FX/operation	Description
FADER SYNTH (SINE/SAW/SQUARE) ²	Outputs the synth sound as the audio source of the base oscillation frequency.
• BEAT ◀/▶:	Base oscillation frequency level: -3 to +3
• LEVEL/DEPTH:	Effect volume
• Sub parameter:	Scale: AUTO SCALE, MAJOR, MINOR, MINOR H, JAPANESE, CHINESE, HAWAIIAN, RYUKYU, 2OCT ANALOG

¹ You cannot monitor the effected sound.

² You cannot adjust the volume with the channel fader when the effect is turned on.

Using Touch FX

You can set and control effects using the touch screen.

1 Touch [TOUCH FX] on the [MENU] screen.

The Touch FX screen appears.

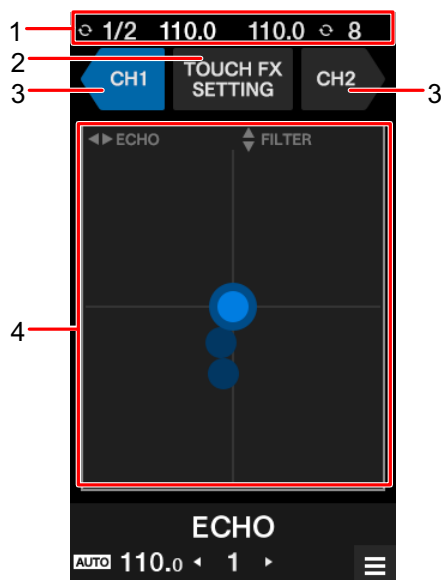

1. **Information display:** Displays BPM and the number of beats for a loop.
2. **TOUCH FX SETTING:** Displays the [TOUCH FX SETTING] screen.
You can set an effect on the [TOUCH FX SETTING] screen.
 - [PRESET FX]: Controls the preset effect.
 - [SELECTED FX]: Controls the selected effect.
3. **CH 1/CH 2:** Selects the channel to apply the effect to.
4. **Touch FX operation part:** Adjusts the parameters for the effect.

➡ Read more: MENU screen (page 15)

- 2 Touch [CH 1] or [CH 2] to select the channel to apply the effect to.
- 3 Touch or slide the Touch FX operation part to adjust the effect.

The selected effect is applied, and the effect value changes according to the point you touch on the screen.

Using FX Bank

You can save effect settings assigned to the [FILTER] knob and the [BEAT FX SELECT] and [SOFTWARE FX SELECT] buttons to FX Banks, and load the FX Banks when you want to use them.

❖ Restrictions on operation

The following restrictions are applied when two computers (PC/Mac) are connected to the unit.

- You can't load an FX Bank.
- You can't change effects by turning the [BROWSE] knob while pressing the [BEAT FX SELECT] button or from [FX SETTING] of the [MENU] screen.
- The Beat FX assigned to the buttons reset to the default settings (i.e. to the effects displayed on the [BEAT FX SELECT] buttons).

The restrictions are not applied in the following cases.

- Input selector switches of [CH 1] and [CH 2] are set to [A].
- Input selector switches of [CH 1] and [CH 2] are set to [B].

Setting an FX Bank

You can set up to four FX Banks using the Setting Utility or from [FX SETTING] on the [MENU] screen.

❖ Setting an FX Bank using Setting Utility

➡ Read more: Launching Setting Utility (page 19)

1 Click the [FX BANK] tab.

- 2 Click **[BANK A]**, **[BANK B]**, **[BANK C]**, or **[BANK D]** to select an FX Bank to save settings to.

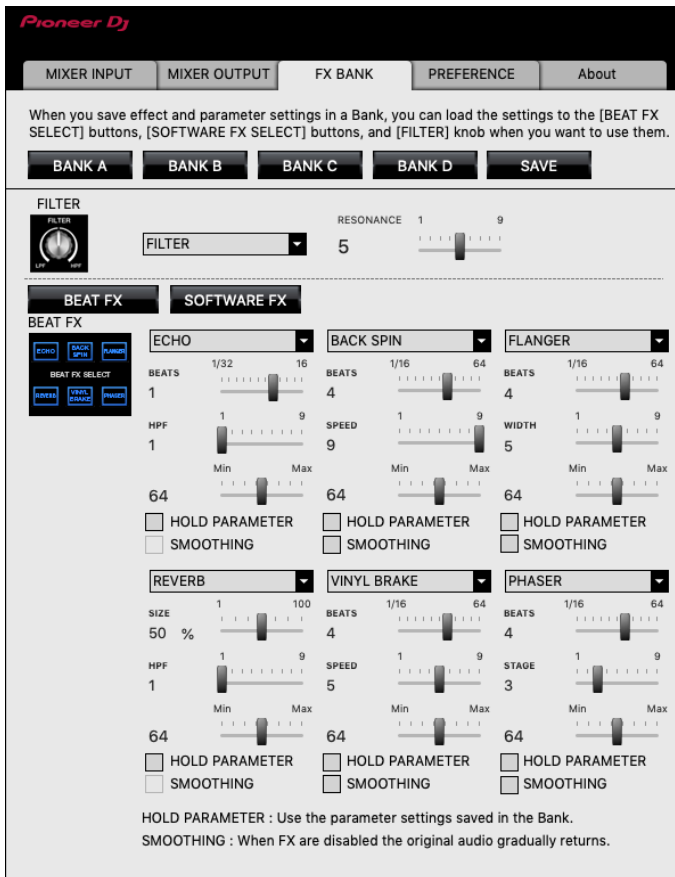

- 3 Select a filter or an effect to assign to the **[FILTER]** knob from the **[FILTER]** pull-down list.

➡ Read more: Effect types and settings (page 51)

- 4 Click **[BEAT FX]** or **[SOFTWARE FX]**.

- 5 Select an effect to assign to each button from the pull-down list.

➡ Read more: Beat FX types and settings (page 55)

6 Mark the check box of [HOLD PARAMETER] or [SMOOTHING] as necessary.

- [HOLD PARAMETER]: Retains the parameters changed after the BANK is called up.
- [SMOOTHING]: Gradually returns to the original sound after the effect turns off.

7 Click [SAVE].

The setting is saved to the FX Bank.

❖ Setting from the FX setting screen

1 Touch [FX SETTING] on the [MENU] screen.

The FX setting screen appears.

➡ Read more: MENU screen (page 15)

2 Touch [A], [B], [C], or [D] to load the FX Bank.

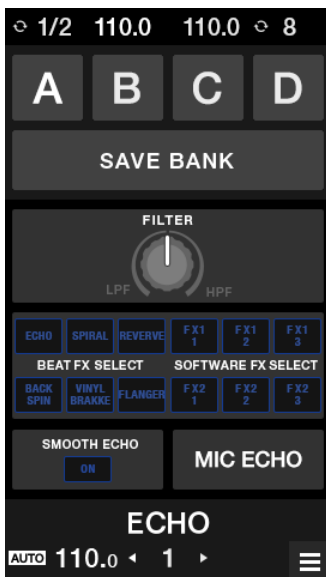

3 Touch [FILTER] and set a filter or an effect to assign to the [FILTER] knob.

4 Touch [BEAT FX SELECT/SOFTWARE FX SELECT] to set a Beat FX to assign.

- If you touch an effect, the detailed setting screen appears.
- You can't change the software effects. Use DJ software to change effects to assign.

5 Touch [SMOOTH ECHO] to set the parameter.

6 Touch [MIC ECHO] to set the parameter.

7 Touch [BANK SAVE].

The setting is saved to the FX Bank.

Changing an assigned effect

You can change the effects assigned to the [BEAT FX SELECT] buttons using the following methods.

- Set from the pull-down lists in Setting Utility (page 63).
- Turn the [BROWSE] knob while pressing the [BEAT FX SELECT] button on the unit.
- Change from the FX setting screen (page 65).

Loading an FX Bank

You can load an FX Bank using the buttons on the unit or from [FX SETTING] on the [MENU] screen.

❖ Loading an FX Bank using buttons on the unit

1 Press the [BEAT ◀] or [BEAT ▶] button while pressing the [SHIFT] button.

FX Bank A, B, C, or D is loaded as follows.

- [BEAT ◀]: Loads the previous FX Bank.
- [BEAT ▶]: Loads the next FX Bank.

- If banks are set in DJ software, the settings are also loaded to the [SOFTWARE FX SELECT] buttons.

❖ Loading an FX Bank from the FX setting screen

1 Touch [FX SETTING] on the [MENU] screen.

The FX Bank setting screen appears.

➡ Read more: MENU screen (page 15)

2 Touch [A], [B], [C], or [D].

The FX Bank is loaded.

Using FX Trigger mode

You can use FX Trigger mode to apply Beat FX using the Performance Pads even when a PC/Mac is not connected to the unit.

Parameter values are pre-assigned to the Performance Pads, so you can apply an effect only by pressing a Performance Pad.

- You can only use FX Trigger mode when one of the Beat FX is selected.

1 Set the input selector switch to [LINE] or [PHONO].

2 Press a Performance Pad.

The specified Beat FX is applied according to the number of beats assigned to the Performance Pad.

Example: When [ECHO] is selected

Performance Pad No.			
1	2	3	4
1/32 beats	1/16 beats	1/8 beats	1/4 beats
5	6	7	8
1/3 beats	1/2 beats	3/4 beat	1 beats

- Release the Performance Pad to turn off the effect.

Smooth Echo

You can use Smooth Echo to easily apply an echo to the sound being played.

Smooth Echo section

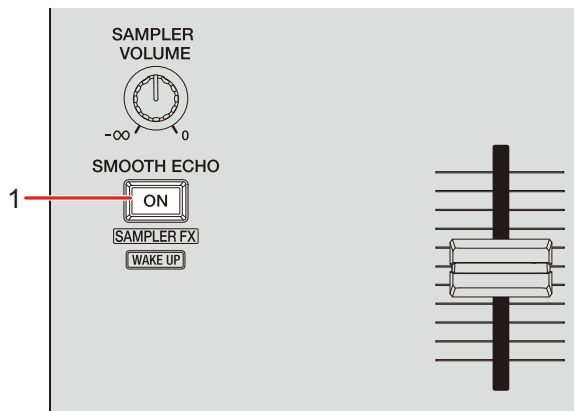

1. **SMOOTH ECHO ON button**
Turns Smooth Echo on and off.

Using Smooth Echo

- 1 **Touch [FX SETTING] on the [MENU] screen.**

The FX setting screen appears.

➡ Read more: MENU screen (page 15)

2 Touch [SMOOTH ECHO].



3 Select a trigger (operation) for the echo effect.

- **[CROSSFADER]**: Applies the echo when the crossfader is moved to the opposite side and the sound is muted.
- **[CH FADER]**: Applies the echo when the sound is muted by the channel fader.
- **[HOT CUE]**: Applies the echo if a Hot Cue is triggered when using DJ software.
- **[GATE CUE]**: Applies the echo if the sound is muted by releasing the Performance Pad in Gate Cue mode when using Serato DJ Pro.
- **[SILENT CUE]**: Applies the echo if a Silent Cue is triggered when using DJ software.
- **[LOAD]**: Applies the echo if a track is loaded when using DJ software.

4 Set the parameters.

- **[BEATS]**: Sets the number of beats for the echo.
- **[LEVEL]**: Adjusts the echo volume.
- **[Number of Beats to trigger(by Crossfader)]**: Sets the number of beats before the echo is applied.

5 Press the [SMOOTH ECHO ON] button to turn on Smooth Echo.

The button lights up when Smooth Echo is turned on.

6 Perform the trigger operation to apply the echo.

A delay sound is output several times while attenuating according to the number of beats.

Loop

You can choose a section of a track to play repeatedly.

Loop section

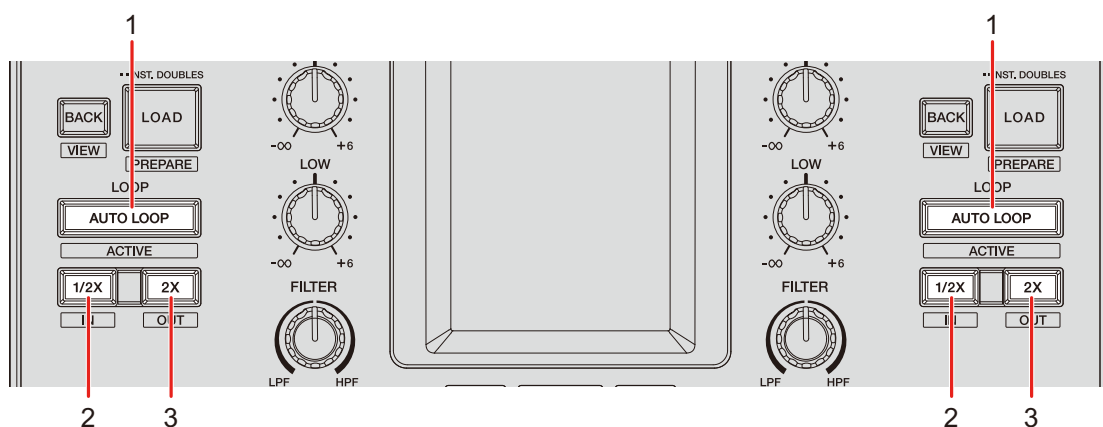

1. **AUTO LOOP** button

Plays a loop of the specified number of beats or Auto Beat Loop.
Press while pressing the **[SHIFT]** button to turn a loop on and off.

- You can choose whether the **[AUTO LOOP]** button starts a loop of the specified number of beats or Auto Beat Loop in **[LOOP options.]** (**[PREFERENCE]** tab) in Setting Utility (page 22) or in the Utility settings on the unit.

2. **1/2X** button

Halves the length of the loop.

3. **2X** button

Doubles the length of the loop.

Using a loop

Setting a loop automatically

- 1 Press the [AUTO LOOP] button during playback.

Loop playback starts from the position where the button is pressed.

Setting a loop manually

- 1 Press the [SHIFT] and [1/2X] buttons at the point where you want to start the loop (loop-in point) during playback.
- 2 Press the [SHIFT] and [2X] buttons at the point where you want the loop to end (loop-out point).

Loop playback of the specified section starts.

Halving the length of a loop

- 1 Press the [1/2X] button during loop playback.

The loop length is halved each time you press the button.

Doubling the length of a loop

- 1 Press the [2X] button during loop playback.

The loop length is doubled each time you press the button.

Using the Performance Pads

You can trigger various functions with the Performance Pads when using the unit with DJ software.

Performance Pad section

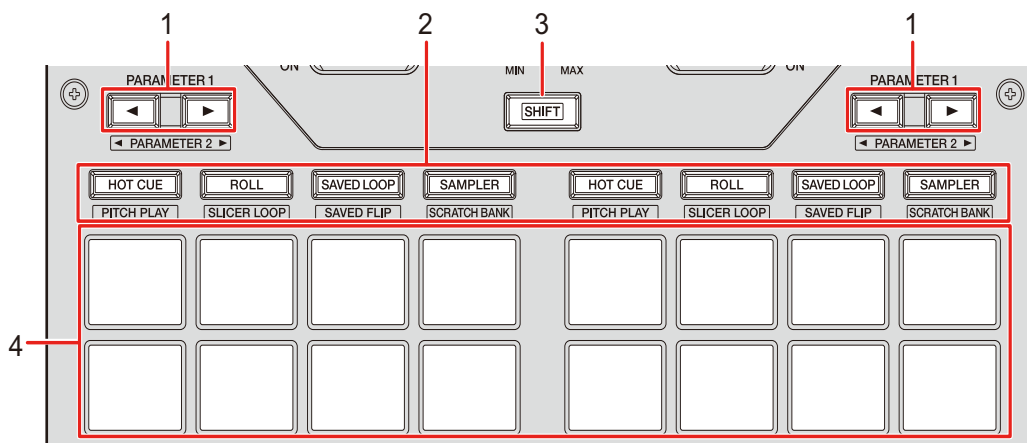

1. **PARAMETER ◀/▶ button**

Switches settings.

2. **Pad mode buttons**

When using the unit with Serato DJ Pro:

Operation	HOT CUE button	ROLL button	SAVED LOOP button	SAMPLER button
Press	Hot Cue	Roll	Saved Loop	Sampler
Press while pressing the [SHIFT] button	Pitch Play	Slicer Loop	Saved Flip	Scratch Bank
Press twice	Gate Cue	Cue Loop	Auto Loop	Transport

Using the Performance Pads

Operation	HOT CUE button	ROLL button	SAVED LOOP button	SAMPLER button
Press twice while pressing the [SHIFT] button	User mode 1	User mode 2	User mode 3	User mode 4

When using the unit with rekordbox:

Operation	HOT CUE button	ROLL button	SAVED LOOP button	SAMPLER button
Press	Hot Cue	Pad FX1	Beat Jump	Sampler
Press while pressing the [SHIFT] button	Keyboard	Pad FX2	Beat Loop	Key Shift

3. **SHIFT button**
4. **Performance Pads**

Serato DJ Pro

Press the Pad mode button (**[HOT CUE]**, **[ROLL]**, **[SAVED LOOP]**, or **[SAMPLER]**) to switch functions.

Combo Pad mode

If you press a Pad mode button while pressing another Pad mode button, you can use two Pad modes at the same time (the supported modes are Hot Cue, Roll, Saved Loop and Sampler modes).

The Pad mode of the button you press first is assigned to the top four Performance Pads and the Pad mode of the button you press next is assigned to the bottom four Performance Pads.

Hot Cue mode

You can call up a Hot Cue quickly and start playback by pressing a Performance Pad.

- You can set up to 8 Hot Cues per track.

1 Press the [HOT CUE] button.

The unit switches to Hot Cue mode.

2 Press a Performance Pad at the point where you want to set a Hot Cue during playback or pause.

A Hot Cue is set.

- Hot Cues are assigned to the Performance Pads as follows.

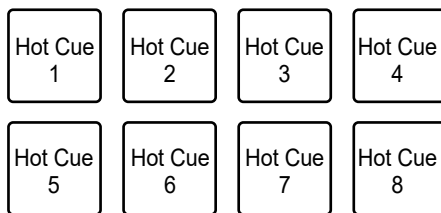

3 Press a Performance Pad to which a Hot Cue is set.

Playback starts from the Hot Cue point.

- Press a Performance Pad while pressing the [SHIFT] button to delete a Hot Cue set to the pad.

Roll mode

Loop Roll playback continues according to the number of beats assigned to a Performance Pad while you press the pad.

1 Press the [ROLL] button.

The unit switches to Roll mode.

Using the Performance Pads

2 Press the [PARAMETER ◀] or [PARAMETER ▶] button.

The numbers of beats assigned to the Performance Pads change as follows each time the button is pressed.

- 1/32 to 4 beats
- 1/16 to 8 beats
- 1/8 to 16 beats
- 1/4 to 32 beats

Example: When set to 1/8 to 16 beats, the numbers of beats are assigned to the Performance Pads as follows.

1/8	1/4	1/2	1
2	4	8	16

The numbers of beats are displayed on the Serato DJ Pro screen.



3 Press the Performance Pad assigned with the number of beats you want to play in a loop.

Loop Roll playback continues according to the number of beats assigned to the Performance Pad while you press the pad.

- Press the [1/2X] or [2X] button during Loop Roll playback to change the number of beats in the Loop Roll being played.
 - Normal playback continues with its original rhythm in the background during Loop Roll playback, but you can't hear this.
-
- Release the Performance Pad to end the Loop Roll playback. Normal playback starts from the exact point the track would have reached by now.

Saved Loop mode

You can save a loop to a loop slot in Serato DJ Pro and call up a saved loop.

1 Press the **[SAVED LOOP]** button.

The unit switches to Saved Loop mode.

2 Press a Performance Pad during loop playback.

Loops are assigned to the loop slots in Serato DJ Pro as follows.

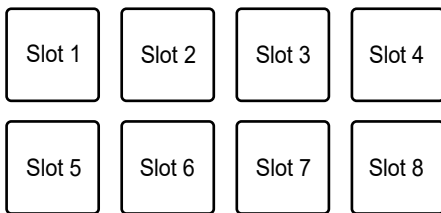

3 Press a Performance Pad to which a loop is assigned while pressing the **[SHIFT]** button.

Loop playback starts from the beginning of the loop.

- Press the **[PARAMETER ◀]** or **[PARAMETER ▶]** button during loop playback to change the length of the loop being played. The setting of the called-up loop is overwritten with the changed setting.
- Press the **[1/2X]** or **[2X]** button while pressing the **[SHIFT]** button during loop playback to move a loop without changing the loop length. The setting of the called-up loop is overwritten with the changed setting.
- Press the Performance Pad again to cancel loop playback.

Sampler mode

You can start playback of a track loaded in a Sampler slot using a Performance Pad.

1 Display the [SAMPLER] pane on the Serato DJ Pro screen.

2 Press the [SAMPLER] button on the unit.

The unit switches to Sampler mode.

3 Press the [PARAMETER ◀] or [PARAMETER ▶] button to switch Sampler Banks.

There are four banks (A, B, C, D) to switch between.

- Each bank has eight slots.

4 Drag and drop a track to each slot on the [SAMPLER] pane to load it on the Serato DJ Pro screen.

The Sampler settings and the loaded tracks are saved.

5 Press the Performance Pad matching the slot (track) you want to play.

Slot playback starts.

- Slots are assigned to the Performance Pads as follows.

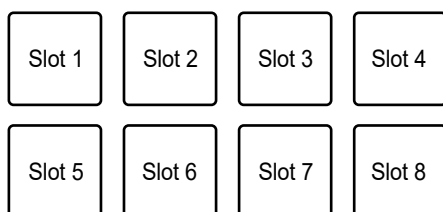

6 Turn the [SAMPLER VOLUME] knob to adjust the volume of the Sampler sound.

- Playback methods differ according to the Sampler mode set in Serato DJ Pro. For details, refer to the Serato DJ Pro software manual (page 7).

Using the Performance Pads

- Press the Performance Pad while pressing the [SHIFT] button to stop slot playback.

Pitch Play mode

Pitch Play is a function of Pitch 'n Time DJ.

1 Press the [HOT CUE] button while pressing the [SHIFT] button.

The unit switches to Pitch Play mode.

2 Press a Performance Pad while pressing the [SHIFT] button.

A Hot Cue assigned to the Performance Pad is selected.

3 Press a Performance Pad.

Playback starts from the selected Hot Cue point according to the pitch assigned to the Performance Pad.

- Press the [PARAMETER ◀] or [PARAMETER ▶] button during Pitch playback to change the pitch range. Each press switches between Up range, Middle range, and Down range.

— Up range:

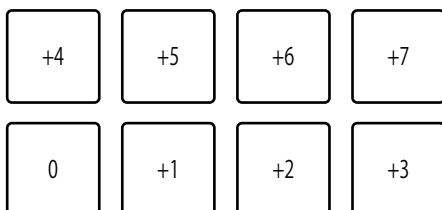

— Middle range:

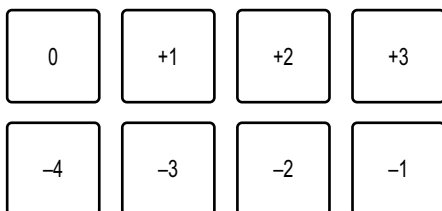

Using the Performance Pads

— Down range:

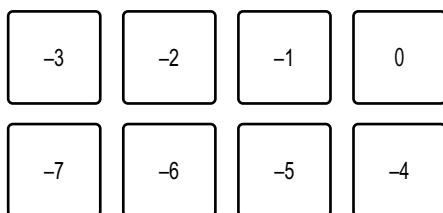

- Press the [PARAMETER ◀] or [PARAMETER ▶] button while pressing the [SHIFT] button to shift the pitch range by a semitone.

Slicer Loop mode

A specified range is applied to the track divided into eight sections. The divided sections are assigned to different Performance Pads.

Loop playback of the section assigned to a Performance Pad continues while you press the Performance Pad.

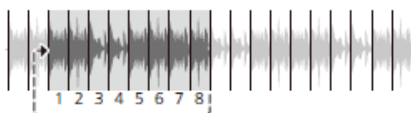

- You can't use Slicer Loop with a track that doesn't have beatgrid set. For details on how to set beatgrid, refer to the Serato DJ Pro software manual (page 7).

1 Press the [ROLL] button while pressing the [SHIFT] button.

The unit switches to Slicer Loop mode.

2 Press the [PARAMETER ◀] or [PARAMETER ▶] button while pressing the [SHIFT] button to specify the range (domain) to divide into eight sections.

- Each press of the button sets the domain as follows from the position where the button is pressed.
 - 2 beats
 - 4 beats
 - 8 beats
 - 16 beats

Using the Performance Pads

- 32 beats
- 64 beats
- Eight sections of a divided domain are assigned to the Performance Pads as follows.
Sections 1 to 8:

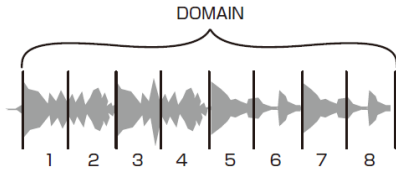

Performance Pads assignment:

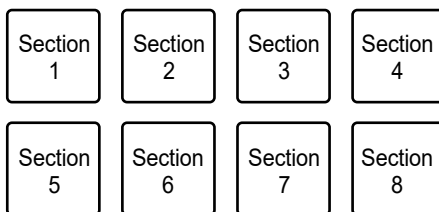

3 Press the [PARAMETER ◀] or [PARAMETER ▶] button to set a Quantization.

Each press of the button sets a Quantization as follows.

- 1/8 (plays a loop of 1/8 length from the beginning of a section)
- 1/4 (plays a loop of 1/4 length from the beginning of a section)
- 1/2 (plays a loop of 1/2 length from the beginning of a section)
- 1 (plays the entire section)

4 Press a Performance Pad assigned with the section you want to play in a loop.

Loop playback continues while you press the Performance Pad.

- Normal playback continues with its original rhythm in the background during Slicer Loop playback, but you can't hear this.
- Release a Performance Pad to end Slicer Loop playback. Normal playback starts from the exact point the track would have reached by now.

Using the Performance Pads

- Playback returns to and continues from the beginning of section 1 if playback reaches the end of a domain.

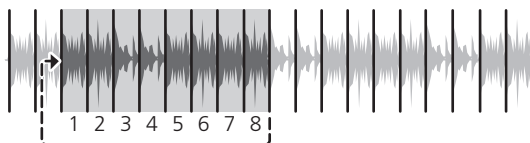

Saved Flip mode

Serato Flip is a function to record or call up a sequence of such as operation of a Hot Cue. You can save and play a Flip using the Performance Pads on the unit.

❖ Registering a Flip to a slot

1 Create a Flip using Serato DJ Pro.

- For details on how to create a Flip, refer to the Serato DJ Pro software manual (page 7).

2 Press the [SAVED LOOP] button while pressing the [SHIFT] button.

The unit switches to Saved Flip mode.

3 Press the Performance Pad for the slot you want to save the Flip to.

The Flip is saved to the slot.

- Slots are assigned to the Performance Pads as follows.

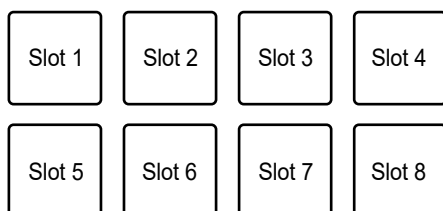

- You can't save a Flip to a slot if all slots have saved Flips already. Delete a Flip on the slot screen in Serato DJ Pro to free up a slot for a new Flip.

❖ Calling up and playing a Flip

1 Press the [SAVED LOOP] button while pressing the [SHIFT] button.

The unit switches to Saved Flip mode.

2 Press the Performance Pad assigned with the slot (Flip) you want to play.

The Flip is called up and playback starts from the beginning of the Flip.

- Slots are assigned to the Performance Pads as follows.

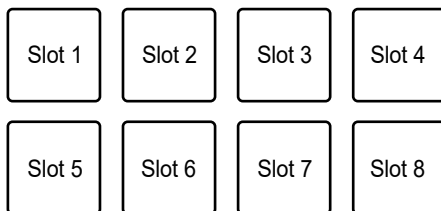

- If you call up a Flip by pressing a Performance Pad while pressing the [SHIFT] button, playback does not start from the beginning. Instead, Flip playback starts when the playback of the track reaches the beginning of the Flip.
 - Press a Performance Pad during Flip playback to move to the beginning of the Flip that's playing.
-
- Press the Performance Pad while pressing the [SHIFT] button to cancel Flip playback and return to normal playback.

Scratch Bank mode

You can load the sound of a Scratch Bank.

- 1 Open the [SCRATCH BANK] pane on the Serato DJ Pro screen.**
- 2 Press the [SAMPLER] button while pressing the [SHIFT] button.**

The unit switches to Scratch Bank mode.

- 3 Press the Performance Pad assigned with the Scratch Bank you want to load.**

The sound of the Scratch Bank is loaded to the unit.

- Slots are assigned to the Performance Pads as follows.

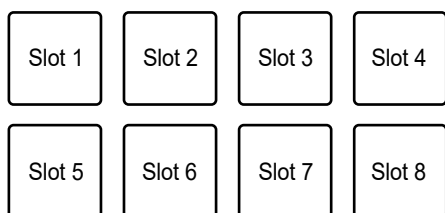

Gate Cue mode

You can play a Hot Cue by using Gate Cue.

- 1 Press the [HOT CUE] button twice in succession.**

The unit switches to Gate Cue mode.

- 2 Press a Performance Pad assigned with a Hot Cue you want to play.**

Playback of the Hot Cue sound continues while you press the Performance Pad.

Using the Performance Pads

- Hot Cues are assigned to the Performance Pads as follows.

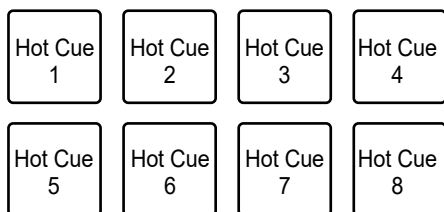

- Release the Performance Pad to mute the sound. Press the Performance Pad again to start playback of the Hot Cue from the beginning.

Cue Loop mode

1 Press the [ROLL] button twice in succession.

The unit switches to Cue Loop mode.

2 During playback, press a Performance Pad at the point where you want to set a loop point.

A loop point is set to a Hot Cue slot, and loop playback starts.

- Loop-in points are assigned to the Performance Pads as follows.

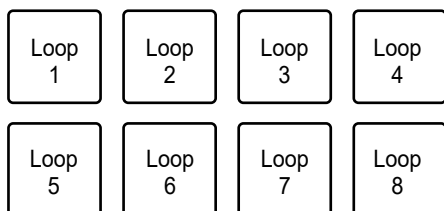

- The number of beats set for Auto Loop is applied to the loop length.
- A Hot Cue is used as a loop-in point for Cue Loop. Press a Performance Pad which is set with a Hot Cue to start loop playback from the Hot Cue point.
- Press the [PARAMETER ◀] or [1/2X] button during loop playback to halve the loop length by half with each press.
- Press the [PARAMETER ▶] or [2X] button during loop playback to double the loop length with each press.

Using the Performance Pads

- Press the Performance Pad again while pressing the **[SHIFT]** button to return to the loop-in point and start playback from there.
- Press the Performance Pad again to cancel loop playback.

Auto Loop mode

If you press a Performance Pad, a loop is set with the number of beats assigned to the Performance Pad and loop playback continues even if you release the Performance Pad.

1 Press the **[SAVED LOOP]** button twice in succession.

The unit switches to Auto Loop mode.

2 Press a Performance Pad during playback.

Loop playback starts according to the number of beats assigned to the Performance Pad.

- The number of beats is displayed on the Serato DJ Pro screen in the same way as the number of beats for Roll (page 75).
- Press the **[PARAMETER ◀]** or **[PARAMETER ▶]** button during loop playback to change the length of a loop being played (page 72).
- Press the **[PARAMETER ◀]** or **[PARAMETER ▶]** button while pressing the **[SHIFT]** button during loop playback to move a loop without changing the loop length.
- Press the Performance Pad again to cancel loop playback.

Transport mode

You can control a track using the Performance Pads without using a turntable or multi player. In Transport mode, functions are assigned to the Performance Pads as follows.

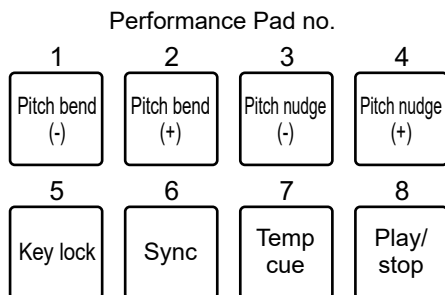

1 Press the [SAMPLER] button twice in succession.

The unit switches to Transport mode.

2 Press a Performance Pad.

- **1 /2**: Adjusts the pitch temporarily.
- **3 /4**: Adjusts the pitch permanently by nudging the track.
Press Performance Pad 3 or 4 while pressing the [SHIFT] button to reset the key.
- **5**: Turns the key lock function on and off.
When key lock is turned on, the pitch doesn't change – even if the tempo of a track is changed. In this scenario, sound quality is lowered due to the digital processing applied.
Press Performance Pad 5 while pressing the [SHIFT] button to switch the Serato DVS playback mode between the internal mode and relative mode.
- **6**: Turns on the sync function.
Automatically synchronizes the tempo (pitch) of tracks on multiple decks when the Serato DVS playback mode is set to relative mode.
Automatically synchronizes the tempo and beatgrids of tracks on multiple decks when the Serato DVS playback mode is set to internal mode.
You can't use the sync function when the Serato DVS playback mode is set to absolute mode.

Using the Performance Pads

Press Performance Pad 6 while pressing the **[SHIFT]** button to turn off the sync function.

- **7:** Sets, calls up, or plays a temporary cue point.

Press during pause to set a temporary cue point.

Press during playback to return to a temporary cue point and pause (Back Cue).

Press after the playback point returns to a temporary cue point to continue playback while pressing the button (Cue Sampler). Press Performance Pad 8 during Cue Sampler playback to continue playback even if you release the Performance Pad.

Press while pressing the **[SHIFT]** button to load a previous track in the track list (Previous Track). If the current playback position is not the beginning of the track, the playback point returns to the beginning of the track.

- **8:** Plays or stops a track.

Press while pressing the **[SHIFT]** button to return to a temporary cue point and continue playback (Stutter).

rekordbox

Press the Pad mode buttons ([**HOT CUE**], [**ROLL**], [**SAVED LOOP**], or [**SAMPLER**]) to switch between modes and use different functions.

Hot Cue mode

You can call up a Hot Cue quickly and start playback by pressing a Performance Pad.

- You can set up to 16 Hot Cues per track.
- The procedure is the same as for Serato DJ Pro. See Hot Cue mode (page 75).
- Hot Cues are assigned to the Performance Pads as follows.

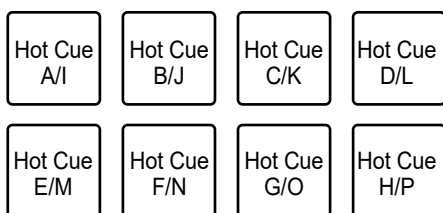

- Press the [**PARAMETER ◀**] or [**PARAMETER ▶**] button to switch Hot Cues between A to H and I to P. At the same time, the Hot Cue display area switches on the deck screen in rekordbox.

Pad FX mode

You can apply effects using the Performance Pads.

1 Press the [**ROLL**] button.

The unit switches to Pad FX mode 1.

- Press the [**ROLL**] button while pressing the [**SHIFT**] button to switch to Pad FX mode 2.

2 Press the Performance Pad assigned with the effect you want to use.

The effect is applied according to the number of beats set to the Performance Pad while you press it.

Using the Performance Pads

- Effects are assigned to the Performance Pads as follows.

Effect A/I	Effect B/J	Effect C/K	Effect D/L
Effect E/M	Effect F/N	Effect G/O	Effect H/P

- Release the Performance Pad to cancel the effect.
- Press the **[PARAMETER ◀]** or **[PARAMETER ▶]** button to switch effects between A to H and I to P. At the same time, the effects display area switches on the deck screen in rekordbox.

Beat Jump mode

You can move the playback point quickly without breaking the rhythm of the track that's playing.

1 Press the **[SAVED LOOP]** button.

The unit switches to Beat Jump mode.

2 Press a Performance Pad.

The playback point moves according to the number of beats or bars assigned to the Performance Pad.

- The number of beats or bars to jump is assigned to the Performance Pads as follows in the default settings.

1 beat (to the left)	1 beat (to the right)	2 beats (to the left)	2 beats (to the right)
4 beats (to the left)	4 beats (to the right)	8 beats (to the left)	8 beats (to the right)

- Press the **[PARAMETER ◀]** or **[PARAMETER ▶]** button to switch the number of beats or bars to assign to the Performance Pads.

Sampler mode

You can play a track loaded to a Sampler slot using the Performance Pads.

❖ Preparation

- 1 Click the Sampler pane icon on the upper part of the rekordbox screen.**

The Sampler pane is displayed on the rekordbox screen.

- 2 Press the [SAMPLER] button on the unit.**

The unit switches to Sampler mode.

- 3 Press the [PARAMETER ◀] or [PARAMETER ▶] button while pressing the [SHIFT] button to switch Sampler Banks.**

Sampler has four banks and each bank has 16 slots.

- The selected Sampler Bank is applied to all the decks.

- 4 Press the [BROWSE] knob to move the cursor to the track list.**

- 5 Turn the [BROWSE] knob to select a track.**

- 6 Press a Performance Pad while pressing the [SHIFT] button.**

The selected track is loaded to the Sampler slot.

- You may not be able to load a track to a Sampler slot which already has a track loaded, depending on the [Preferences] settings in rekordbox.

Using the Performance Pads

❖ Playing a Sampler track

1 Press the [SAMPLER] button.

The unit switches to Sampler mode.

2 Press the [PARAMETER ◀] or [PARAMETER ▶] button while pressing the [SHIFT] button to switch Sampler Banks.

3 Adjust the Sampler gain on the rekordbox screen.

4 Press a Performance Pad.

Playback of the slot assigned to the Performance Pad starts.

- Slots are assigned to the Performance Pads as follows.

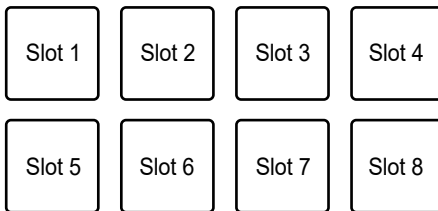

- Press a Performance Pad during Sampler playback to return to the beginning and continue playback.

5 Turn the [SAMPLER VOLUME] knob to adjust the volume for the Sampler sound.

- Press the Performance Pad again while pressing the [SHIFT] button to stop playback.

Keyboard mode

You can change the scale of a Hot Cue using the Performance Pads like a keyboard.

1 Press the [HOT CUE] button while pressing the [SHIFT] button.

The unit switches to Keyboard mode.

2 Press the [PARAMETER ◀] or [PARAMETER ▶] button to switch the keys to assign to the Performance Pads.

3 Press the Performance Pad assigned with the Hot Cue you want to use.

- If a Hot Cue is not assigned to the Performance Pad, the current playback position is set as a Hot Cue to be used in Keyboard mode.
- Press the [HOT CUE] button while pressing the [SHIFT] button to change a Hot Cue.

4 Press a Performance Pad.

Playback of the Hot Cue starts according to the key assigned to the Performance Pad.

Beat Loop mode

If you press a Performance Pad, a loop is set with the number of beats or bars assigned to the Performance Pad, and the loop playback continues even if you release the Performance Pad.

1 Press the [SAVED LOOP] button while pressing the [SHIFT] button.

The unit switches to Beat Loop mode.

2 Press a Performance Pad.

Loop playback starts according to the number of beats or bars assigned to the Performance Pad.

- The number of beats or bars for Beat Loop is assigned to the Performance Pads as follows.

1/64 beats	1/32 beats	1/16 beats	1/8 beats
1/4 beats	1/2 beats	1 beat	2 beats

- Press the [PARAMETER ◀] or [PARAMETER ▶] button to switch the number of beats or bars to assign to the Performance Pads. At the same time, the Beat Loop display area is switched on the deck screen in rekordbox.
- Press the Performance Pad again to cancel loop playback.

Key Shift mode

You can shift the key of a track that's playing according to the keys assigned to the Performance Pads.

- 1 Press the [SAMPLER] button while pressing the [SHIFT] button.**

The unit switches to Key Shift mode.

- 2 Press the [PARAMETER ◀] or [PARAMETER ▶] button to switch the keys to assign to the Performance Pads.**

- 3 Press a Performance Pad.**

The key of the track that's playing is shifted to the key assigned to the Performance Pad.

Pad editor

You can customize the functions to assign to the Performance Pads on the unit using rekordbox.

For details on the pad editor, refer to the instruction manual for rekordbox at the URL below.

rekordbox.com/manual

User mode

You can assign DJ software functions to the Performance Pads on the unit using the MIDI assigning mode in most types of DJ software.

- Find out about the MIDI assigning mode of your DJ software in the relevant user manual.

Using User modes

The unit supports four User modes. You can assign functions to eight pads for each User mode.

This section describes an example of how to use User modes with Serato DJ Pro.

1 Press the [HOT CUE], [ROLL], [SAVED LOOP], or [SAMPLER] button twice in succession while pressing the [SHIFT] button.

- [HOT CUE]: Switches to User mode 1.
- [ROLL]: Switches to User mode 2.
- [SAVED LOOP]: Switches to User mode 3.
- [SAMPLER]: Switches to User mode 4.

2 Click [MIDI] on the Serato DJ Pro screen.

Serato DJ Pro switches to MIDI assigning mode.

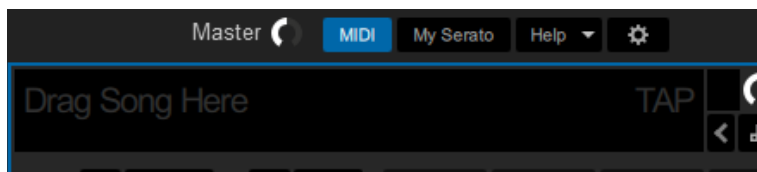

3 Click a function to assign to a Performance Pad on the unit.

Example: When assigning [▶] (PLAY/PAUSE)

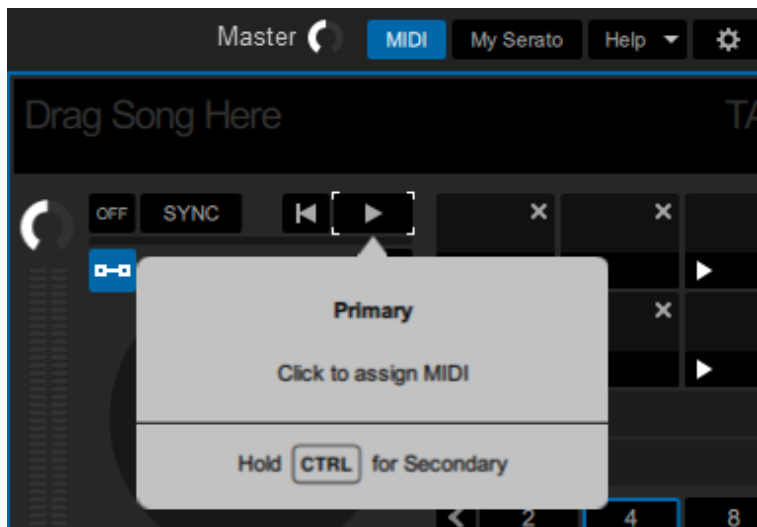

4 Press a Performance Pad to assign the selected function to.

If the assignment works, the confirmation message appears.

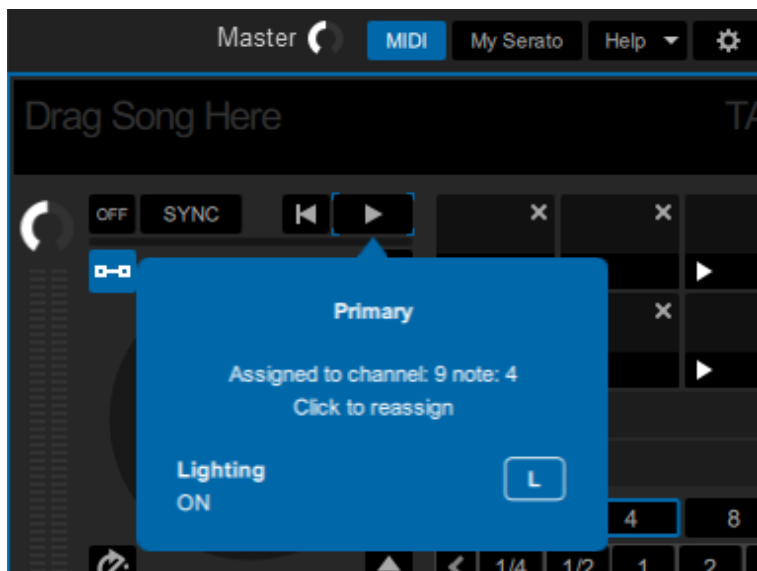

- Click [MIDI] to exit MIDI assigning mode.
- Switch to the relevant User mode after you've finished making settings to use the Serato DJ Pro functions assigned to the Performance Pads.

Fader Start

You can start playback by moving the fader knobs.

Using Fader Start

To use the Fader Start function, mark the check box of **[Fader Start options.]** on the **[PREFERENCE]** tab in Setting Utility or in the Utility settings on the unit.

➤ Read more: Changing the settings (page 22)

Using Channel Fader Start

1 Set a cue.

- To find out how to set a cue point, refer to the user manual for your DJ software.
- You can set a cue by moving the channel fader to the bottom position while pressing the **[SHIFT]** button when a track is paused.

2 Move the channel fader up from the bottom position while pressing the **[SHIFT]** button.

Playback of the track starts from the cue point.

- Move the channel fader back to the bottom position while pressing the **[SHIFT]** button during playback to quickly return to the cue point and pause playback (Back Cue).
- If a cue is not set, playback starts from the beginning of the track.
- You can set whether the sync function will turn on when Channel Fader Start is triggered (only for use with Serato DJ Pro) on the **[PREFERENCE]** tab in Setting Utility (page 22).
- Move the channel fader to the bottom position while pressing the **[SHIFT]** button during cue standby to start playback from the cue point.

Using Crossfader Start

1 Set a cue.

- For details on how to set a cue point, refer to the user manual for your DJ software.
- You can set a cue by moving the crossfader all the way to the left or right side while pressing the **[SHIFT]** button during pause.

2 Set the crossfader all the way to the left side or right side.

- Set the crossfader to the opposite side of the channel which starts playback via Crossfader Start.

3 Move the crossfader away from the left or right side while pressing the **[SHIFT]** button.

Playback of the track starts from the cue point.

- Move the crossfader all the way back to the left or right side while pressing the **[SHIFT]** button during playback to quickly return to the cue point and pause playback (Back Cue).
- If a cue is not set, playback starts from the beginning of the track.
- Move the crossfader all the way from one side to the other while pressing the **[SHIFT]** button during cue standby to start playback from the set cue point.

Deck 3/deck 4

You can control deck 3 and deck 4 in your DJ software from the unit.

Using deck 3/deck 4

1 Touch [DECK 3] or [DECK 4] on the [MENU] screen.

The deck 3 and deck 4 control screen appears.

➤ Read more: MENU screen (page 15)

2 Touch the buttons on the screen.

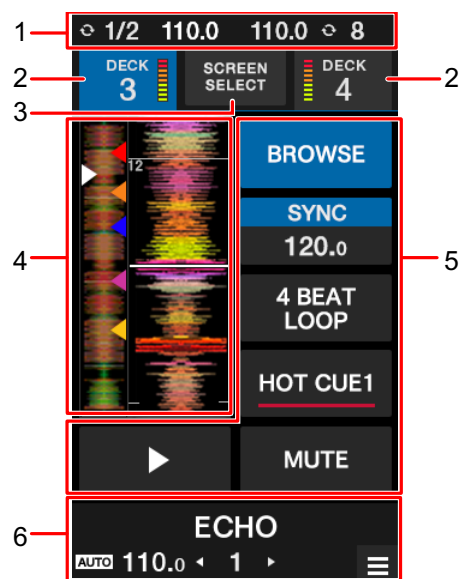

1. **Information display:** Displays BPM and the number of beats for a loop on deck 1 and deck 2.
2. **DECK 3/DECK 4 display and level meter:** Touch to switch the decks. The selected deck's button is highlighted.
3. **SCREEN SELECT:** Touch to display the mode selection screen (page 101).
4. **Waveform display:** Displays overall waveform, detailed waveform, Hot Cue points, etc. that are analyzed by your DJ software.
5. **Controls:** Touch to control the functions.

6. **Effect display/MENU button:** Displays the information for the selected effect. Touch to display the [MENU] screen.

Selecting a mode

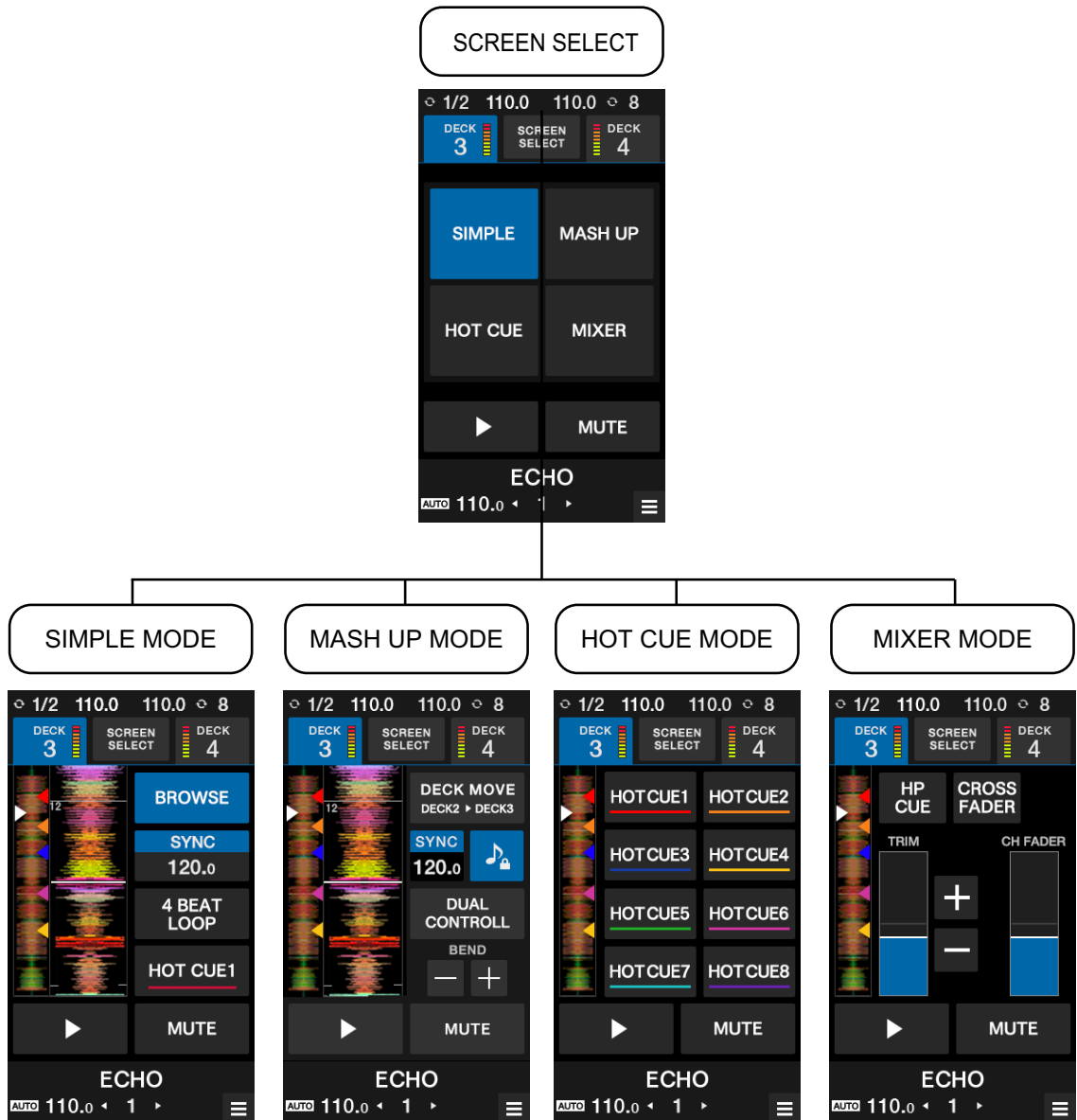

— **[SIMPLE]:** Basic mode.

- **[BROWSE]:** Displays the browse screen for deck 3/deck 4 (page 35).
- **[SILENT CUE]:** Mutes the sound of the track that's playing. Touch it again to cancel the mute. You can also cancel the mute by calling up a Hot Cue.
- **[SYNC], [4BEAT LOOP], [HOT CUE1], and [PLAY]:** Controls the functions in your DJ software.

— **[ADVANCED]:**

When using the unit with Serato DJ Pro:

- **[DECK MOVE]:** Moves a track from deck 2 to deck 3 or from deck 1 to deck 4.
- **[DUAL DECK]:** Turns Dual Deck mode on and you can control two decks (deck 1 and deck 3, or deck 2 and deck 4) at the same time.

You can control the following functions in Dual Deck mode.

Buttons/knobs	Function
DVS operation with a turntable, Jog wheel operation when HID is in use	Deck playback operation
TRIM	Volume control
HI, MID, LOW	ISO/EQ adjustment
Channel fader	Volume control
Crossfader	Volume control
FILTER	Filter and other effects adjustment
Effect section	Effect control
Performance Pad section	Control of Hot Cue, etc.
Headphones section	Adjustment of the sound output to the headphones.
Loop section	Loop control
Controls on the waveform screen	Sync and Key Lock control

- **[SYNC], [KEYLOCK], and [BEND]:** Controls the functions in your DJ software.

— **[HOT CUE]:** Controls up to eight Hot Cues.

— **[MIXER]**

- **[HP CUE]:** Outputs sound to headphones.
- **[CROSSFADER ASSIGN]:** Assigns output sound to the crossfader.
- **[TRIM]:** Adjusts volume of the input sound.
- **[CH FADER]:** Adjusts volume.

Touch MIDI

You can control MIDI compatible software from the touch screen of the unit.

Using Touch MIDI

1 Touch [TOUCH MIDI] on the [MENU] screen.

The Touch MIDI screen appears.

➤ Read more: MENU screen (page 15)

2 Touch the buttons on the screen.



1. **Display information:** Displays BPM and the number of beats for a loop.
2. **MIDI type:** Touch to switch MIDI types.
3. **MIDI controls:** Touch to control the functions of your DJ software.

Settings

Changing the settings

You can change the settings of the unit from the Utility menu.

If a PC/Mac is connected to the unit when you change the settings, the changed settings are saved to the PC/Mac. The saved settings are applied to the unit the next time the PC/Mac is connected.

1 Touch on the [MENU] screen.

The Utility menu is displayed.

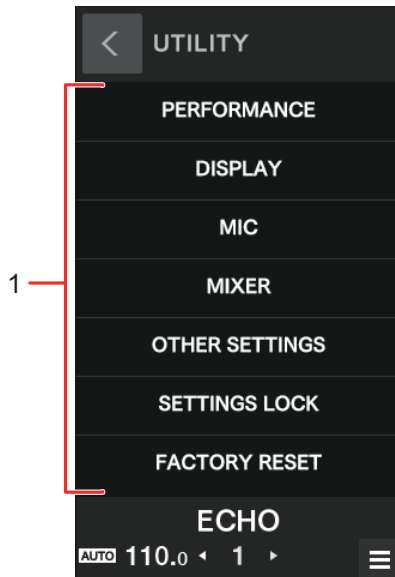

1. **Utility menu** (page 105)

 Read more: MENU screen (page 15)

2 Touch a menu to select.

3 Touch a setting to select.

Utility settings

❖ PERFORMANCE menu

*: Factory setting

Setting item	Description
CROSSFADER	
CROSSFADER CUT LAG	<p>Sets the range where sound is not output at both sides of the crossfader.</p> <ul style="list-style-type: none"> Setting values: 0 to 7* to 52
CROSSFADER SMOOTHING	<p>Sets the function to smooth the rapid variation in volume when you move the crossfader.</p> <ul style="list-style-type: none"> Setting values: NONE*, SMALL, LARGE
CROSSFADER THRU	<p>Sets whether or not the crossfader is in use.</p> <ul style="list-style-type: none"> Set to [ON] when you don't want to use the crossfader. Setting values: OFF*, ON
LOOP OPTIONS	
LOOP OPTION	<p>Sets the function (loop playback with specified number of beats or Auto Loop) that's triggered when you press the [AUTO LOOP] button.</p> <ul style="list-style-type: none"> Setting values: OFF*, ON
LOOP LENGTH	<p>Sets the number of beats to use when [LOOP OPTION] is set to [ON].</p> <ul style="list-style-type: none"> Setting values: 1/4, 1/2, 1, 2, 4*, 8, 16
PAD MODE OPTIONS	
PAD MODE OPTIONS	<p>Sets the button to use for switching Performance Pad mode.</p> <ul style="list-style-type: none"> Setting values: SHIFT*, MULTI

Setting item	Description
--------------	-------------

LOAD OPTIONS

LOAD OPTIONS	<p>Sets whether to move the cursor down after loading a track.</p> <ul style="list-style-type: none"> Setting values: OFF*, ON
---------------------	---

FADER START

FADER START	<p>Sets the function that's triggered by Fader Start.</p> <ul style="list-style-type: none"> Setting values: OFF*, CUE, HOT CUE
--------------------	---

FADER START SYNC	<p>Sets whether to turn on the sync function when Fader Start is triggered.</p> <ul style="list-style-type: none"> Setting values: OFF*, ON
-------------------------	--

❖ DISPLAY menu

*: Factory setting

Setting items	Description
---------------	-------------

WAVEFORM DISPLAY CONTENTS

SYNC & KEYLOCK BUTTON	<p>Sets whether or not to lock the Beat sync display and key lock icon on the screen.</p> <ul style="list-style-type: none"> Setting values: OFF, ON*
----------------------------------	--

FX DISPLAY	<p>Sets whether or not to display the effect information.</p> <ul style="list-style-type: none"> Setting values: OFF, ON*
-------------------	--

Setting items	Description
WAVEFORM DISPLAY OVERLAY	
PAD MODE DISPLAY	<p>Sets whether or not to display the Pad mode name when the Pad mode is switched.</p> <ul style="list-style-type: none"> Setting values: OFF, CHANGE*, ALWAYS
BEAT COUNTDOWN	<p>Sets whether or not to display the number of beats or bars until to the next Hot Cue point.</p> <ul style="list-style-type: none"> Setting values: OFF*, BARS, BEATS
STATUS DISPLAY	<p>Sets whether or not to display the DJ software status.</p> <ul style="list-style-type: none"> Setting values: OFF, ON*
BROWSE DISPLAY	
TRACK LINES	<p>Sets the number of information lines for each track on the browse screen.</p> <ul style="list-style-type: none"> Setting values: 2LINES*, 1LINE
BROWSE AUTO TRANSITION	<p>Sets whether or not to automatically display the browse screen when the [BROWSE] knob is turned.</p> <ul style="list-style-type: none"> Setting values: OFF, ON*
FONT SIZE	<p>Sets the font size for the browse screen. If you set to other than [MID], only English will be displayed.</p> <ul style="list-style-type: none"> Setting values: SMALL, MID*, LARGE
WAVEFORM TOUCH FUNCTION	
WAVEFORM TOUCH FUNCTION	<p>Sets the function that's triggered by a touch on the waveform.</p> <ul style="list-style-type: none"> Setting values: OFF*, BEND, DECK MOVE
NEEDLE SEARCH with SHIFT PRESS	<p>Turns the Needle Search function on and off.</p> <ul style="list-style-type: none"> Setting values: OFF, ON*

Setting items	Description
---------------	-------------

SCREEN SETTING

LCD BRIGHTNESS	<p>Sets the brightness of the touch screen.</p> <ul style="list-style-type: none"> Setting values: 1, 2, 3*, 4, 5
-----------------------	---

❖ MIC menu

*: Factory setting

Setting items	Description
---------------	-------------

MIC TALKOVER

MIC TALKOVER	<p>Sets the talkover mode for the microphone.</p> <ul style="list-style-type: none"> Setting values: OFF*, ADVANCED, NORMAL
---------------------	---

MIC TALKOVER LEVEL	<p>Sets the talkover level for the microphone.</p> <ul style="list-style-type: none"> Setting values: -6dB, -12dB, -18dB*, -24dB
---------------------------	---

MIC LOW CUT

MIC LOW CUT	<p>Sets the low-frequency cut function for the microphone sound.</p> <ul style="list-style-type: none"> Setting values: OFF, ON*
--------------------	---

MIC OUTPUT

MIC TO BOOTH	<p>Sets whether or not to mix the microphone sound into the booth output sound.</p> <ul style="list-style-type: none"> Setting values: OFF, ON*
---------------------	--

MIC TO REC	<p>Sets whether or not to mix the microphone sound into the REC output sound.</p> <ul style="list-style-type: none"> Setting values: OFF, ON*
-------------------	--

Setting items	Description
---------------	-------------

MIC LIMITER

MIC LIMITER for MASTER

Sets whether or not to use the limiter for the microphone sound input to the master output sound.

- Setting values: **OFF***, **ON**

MIC LIMITER for BOOTH

Sets whether or not to use the limiter for the microphone sound input to the sound output to the [BOOTH] terminals.

- Setting values: **OFF***, **ON**

❖ MIXER menu

*: Factory setting

Setting items	Description
---------------	-------------

PHONO ATT

CH1 PHONO ATT. for DVS

Adjusts the control tone signal level for CH 1.

- Setting values: **-6dB** to **-3dB*** to **0dB**

CH2 PHONO ATT. for DVS

Adjusts the control tone signal level for CH 2.

- Setting values: **-6dB** to **-3dB*** to **0dB**

ISOLATOR/EQ

CH1 ISOLATOR/EQ

Sets the function to adjust with the [HI], [MID], and [LOW] knobs for CH 1.

- Setting values: **EQ**, **ISO***

CH2 ISOLATOR/EQ

Sets the function to adjust with the [HI], [MID], and [LOW] knobs for CH 2.

- Setting values: **EQ**, **ISO***

AUX INPUT LEVEL

AUX INPUT LEVEL

Sets the input level for AUX.

- Setting values: **0dB***, **12dB**

Setting items	Description
MASTER OUT ¹	
PEAK LIMITER	Reduces distortion to the sound output from the [MASTER 1] and [MASTER 2] terminals. <ul style="list-style-type: none"> Setting values: OFF, ON*
MASTER OUT ATT	Sets the attenuation level for the sound output from the [MASTER 1] and [MASTER 2] terminals. <ul style="list-style-type: none"> Setting values: -12dB, -6dB, 0dB*
MONO/STEREO	Sets the output method (mono/stereo) for the sound output from the [MASTER 1] and [MASTER 2] terminals. <ul style="list-style-type: none"> Setting values: MONO, STEREO*

BOOTH OUT ¹

BOOTH ATT.	Sets the attenuation level for the sound output from the [BOOTH] terminals. <ul style="list-style-type: none"> Setting values: -12dB, -6dB, 0dB*
MONO/STEREO	Sets the output method (mono/stereo) for the sound output from the [BOOTH] terminals. <ul style="list-style-type: none"> Setting values: MONO, STEREO*

❖ **OTHER SETTINGS menu**

*: Factory setting

Setting items	Description
AUTO STANDBY	Sets the auto standby function (page 111). <ul style="list-style-type: none"> Setting values: OFF, ON*
LED BRIGHTNESS	Sets the brightness of the buttons and Performance Pads. <ul style="list-style-type: none"> Setting values: 1*, 2, 3

Setting items	Description
---------------	-------------

PC UTILITY	Launches Setting Utility (page 19). • Setting values: AUTO , * OFF
-------------------	---

❖ FACTORY RESET menu

Setting items	Description
---------------	-------------

FACTORY RESET	Restores the factory settings. • Setting values: OK , CANCEL
----------------------	---

❖ SETTINGS LOCK menu

*: Factory setting

Setting items	Description
---------------	-------------

SETTINGS LOCK	Sets whether or not to lock the MIC and MIXER menus. • Setting values: LOCK* , UNLOCK
----------------------	--

Auto standby

When [**AUTO STANDBY**] is set to [**ON**], the unit enters Standby mode after 10 hours without being used (when no audio signal is input to the channels on the unit).

Press the [**SMOOTH ECHO ON**] button to exit standby mode.

- The factory setting is [**ON**].
- Set [**AUTO STANDBY**] to [**OFF**] if you don't need to use the auto standby function.

Replacing the bumper for the crossfader

Be sure to follow the directions for safe use of the product.

Note that if you replace parts of the unit, you do so under your own responsibility.

WARNING

- Turn the unit off before starting the work.
- Never turn the unit on until the work is complete.
- Never touch areas other than the indicated ones.
- Never use parts other than those supplied.
- Take care not to drop the removed parts inside the unit.
- Do not work with wet hands.
- Do not work with liquids placed nearby.
- Do not work in a place where this unit may come into contact with liquids.

CAUTION

Perform the replacement with attention to the following.





- Work in a flat and non-slip place.
- Do not work in a dusty place.
- Store the removed parts in a safe place until you reinstall them.
- Keep small parts out of the reach of children and infants. If accidentally swallowed, contact a doctor immediately.
- If you drop parts inside the unit and can't retrieve them, leave the unit's power switched off and disconnect the power cord. Then contact a service center to request repairs.

DISCLAIMER

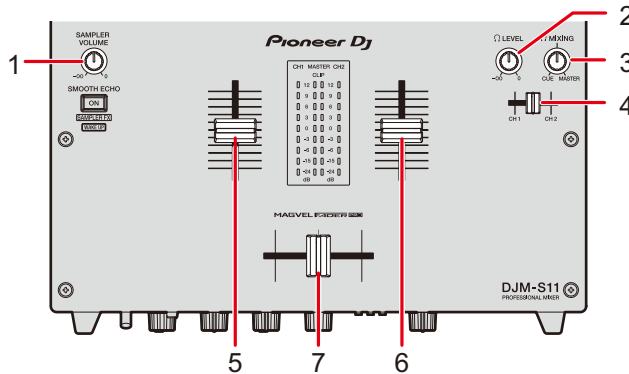
- If you replace parts of the unit, you do so under your own responsibility. Read the descriptions in this document carefully and perform the work with caution.
- Note that we will accept no responsibility whatsoever for any loss or damage resulting from the replacement of parts.
- If you lose or damage the parts during replacement, you will need to pay for new replacement parts, even within the warranty period.
- If malfunctions, damages, or any other conditions that require repair occur with this product as a result of the replacement of parts, you will need to pay for the necessary repairs, even within the warranty period. (The unit may not fit for repair, depending on the damaged condition.)

- 1 Turn the unit off.
- 2 Remove the seven knobs shown below.



No.	Name of part	Part
1	SAMPLER VOLUME knob ¹	Rotary knob
2	 LEVEL knob ¹	
3	 MIXING knob ¹	Fader knob (small)
4	Headphones cue fader ¹	
5,6	Channel fader	Fader knob (large)
7	Crossfader	

¹ Attached by insertion. Pull them out upwards to remove. If it's difficult to pull them out, wrap them with something that doesn't slip and pull them out.

- The fader knobs (large) consist of the following parts.

Parts

Indicating line



Parts

Knob



Base



- Disassemble the fader knobs (large) as follows.

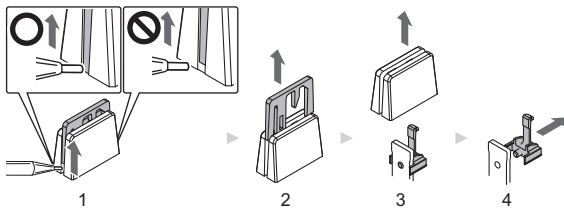

- Lift the bottom edge of the indicating line with a fine-tipped tool.
 - Lift the side where the bottom edge of the indicating line extends to the bottom of the knob.
- Pull out the indicating line (upwards).
- Pull out the knob (upwards).
- Pull out the base (sideways).

3 Remove six screws using a screwdriver.

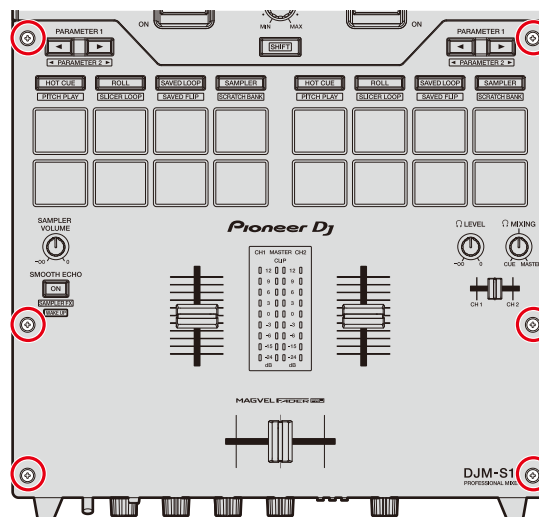

- Use a size 1 screwdriver. Screwdrivers other than size 1 may damage the screws.

4 Remove the aluminum panel.

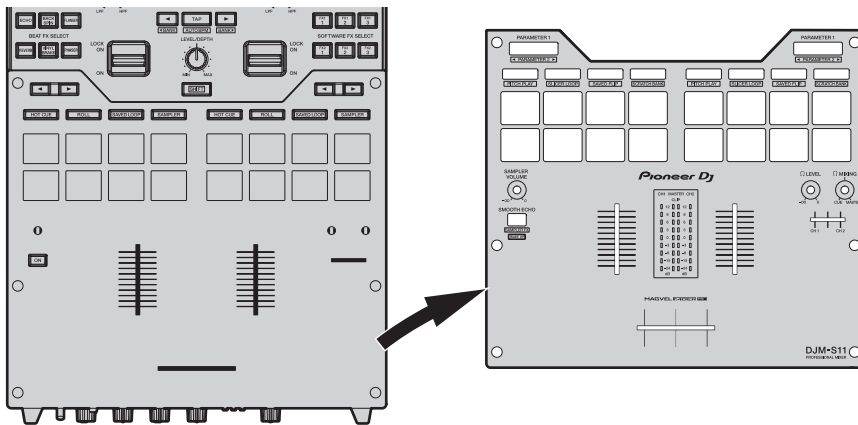

5 Replace the bumper.

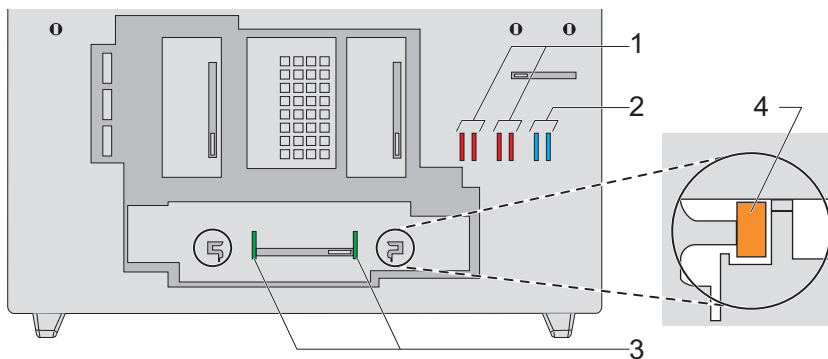

No. Parts

1 **Fader bumper A (hard)**

2 **Fader bumper B (soft)**

3 **Fader bumper C (medium hard)**

- You can replace the preinstalled fader bumper C with the bumper of your preferred hardness.
- Use tweezers if it's difficult to remove the bumper.
- Take care not to drop the bumper inside the unit.
- Do not turn or pull the bumper with excessive force, or you may damage the bumper.

- After you've replaced the bumper, adjust the range where sound is not output at both sides of the crossfader (page 105).
- You can fix the fader unit by inserting fader bumper A vertically into the grooves (4 in the diagram above) on both edges of the fader unit as necessary.

6 Attach the aluminum panel, then tighten the six parts with the screws.

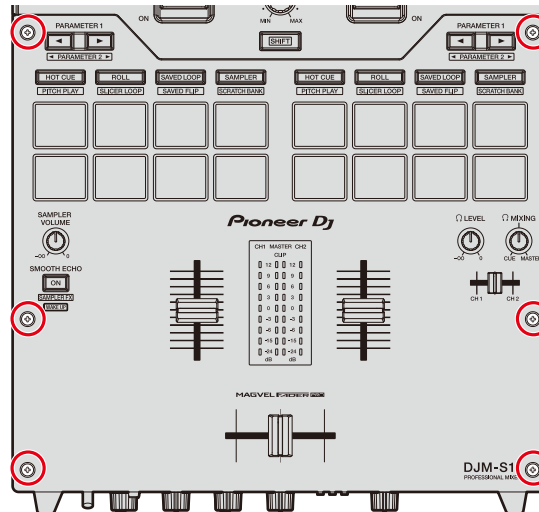

- Check that no parts or dust fell inside the unit before you tighten the screws.
- Do not tighten the screws too much, or you may damage them.
- Be careful not to strip the screw thread (cross-recess) when tightening a screw.
- Never install the screws at an angle, or you may damage the parts.

7 Reattach the seven knobs.

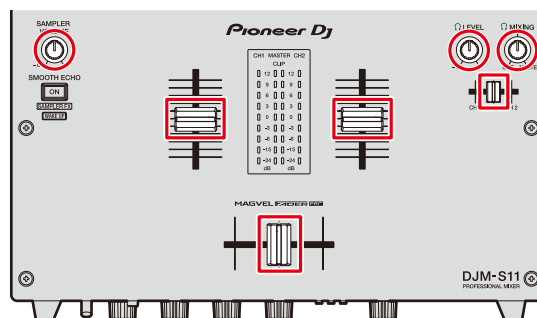

- Insert and push the rotary knobs and fader knob (small) straight in to reattach them.
- Insert the axis through the center hole on the fader knob (small) to attach it.
- Check the orientation of the axes (D cut side) and attach the rotary knobs by aligning them parallel to the axes.
- Do not attach the parts at an angle or insert them with excessive force, or you may damage the parts.
- Assemble the fader knobs (large) as follows.

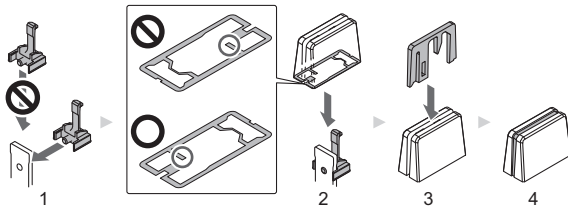

1. Insert the base from the side.
2. Insert the knob in the correct orientation.
3. Insert the indicating line in the correct orientation.

Buying parts

- You can buy replacement parts in cases when certain parts are lost or damaged.

Part	Quantity
Rotary knob	1
Fader knob (small)	1
Fader knob (large) (indicating line)	1
Fader knob (large) (knob)	1
Fader knob (large) (base)	1
Screw	1
Fader bumper A	1
Fader bumper B	1
Fader bumper C	1

Specifications

Main unit weight	5.2 kg (11.5 lbs)
Max. dimensions	267 mm (W) × 452.2 mm (D) × 107.9 mm (H) (10.5 in. (W) × 17.8 in. (D) × 4.2 in. (H))
Tolerable operating temperature	+5 °C to +35 °C (+41 °F to +95 °F)
Tolerable operating humidity	5% to 85% (no condensation)

Audio Section

Sampling rate	48 kHz
MASTER D/A converter	32 bits
CH input A/D converter	24 bits
Other A/D, D/A converters	24 bits
Frequency characteristic	
USB, LINE, MIC, AUX	20 Hz to 20 kHz
S/N ratio (rated output, A-WEIGHTED)	
USB	115 dB
LINE	105 dB
PHONO	90 dB
MIC	80 dB
AUX	90 dB
Total harmonic distortion (20 Hz to 20 kHzBW)	
USB	0.003%
LINE	0.005%
Standard input level/input impedance	
LINE	-12 dBu/47 kΩ
PHONO	-52 dBu/47 kΩ
MIC	-57 dBu/3.3 kΩ
AUX	-12 dBu/47 kΩ
Maximum input level	
PHONO	-17.8 dBu
LINE	+15 dBu
MIC	+2.3 dBu
AUX	+17 dBu (0 dB) / +5 dBu (12 dB)
Standard output level/load impedance/output impedance	
MASTER 1	+6 dBu/10 kΩ/390 Ω or less
MASTER 2	+2 dBu/10 kΩ/390 Ω or less

Specifications

BOOTH	+6 dBu/10 k Ω /390 Ω or less
PHONES	+8 dBu/32 Ω /10 Ω or less
Rated output level/load impedance	
MASTER 1	+25 dBu/10 k Ω
MASTER 2	+21 dBu/10 k Ω
BOOTH	+25 dBu/10 k Ω
Crosstalk	
LINE	82 dB
Channel equalizer characteristic	
ISO	
HI.....	$-\infty$ dB to +6 dB (20 kHz)
MID	$-\infty$ dB to +6 dB (1 kHz)
LOW	$-\infty$ dB to +6 dB (20 Hz)
EQ	
HI.....	-26 dB to +6 dB (20 kHz)
MID	-26 dB to +6 dB (1 kHz)
LOW	-26 dB to +6 dB (20 Hz)
Microphone equalizer characteristic	
HI.....	-12 dB to 12 dB (10 kHz)
LOW	-12 dB to 12 dB (100 Hz)

Input/output terminals

LINE input terminal	
RCA pin jacks	2 sets
PHONO input terminal	
RCA pin jacks	2 sets
MIC input terminal (XLR/TRS)	
XLR connector & 1/4" TRS jack	1 set
AUX input terminal	
RCA pin jacks	1 set
MASTER output terminal	
XLR connector	1 set
RCA pin jacks	1 set
BOOTH output terminal	
1/4" TRS jacks.....	1 set
PHONES output terminal	
1/4" stereo phone jack.....	1 set
3.5 mm stereo mini jack	1 set

Specifications

CDJ/CONTROLLER terminal

- USB type A 2 sets
- Power supply5 V/500 mA or less

USB terminal

- USB type B 2 sets

The specifications and design of this product are subject to change without notice.

Block diagram

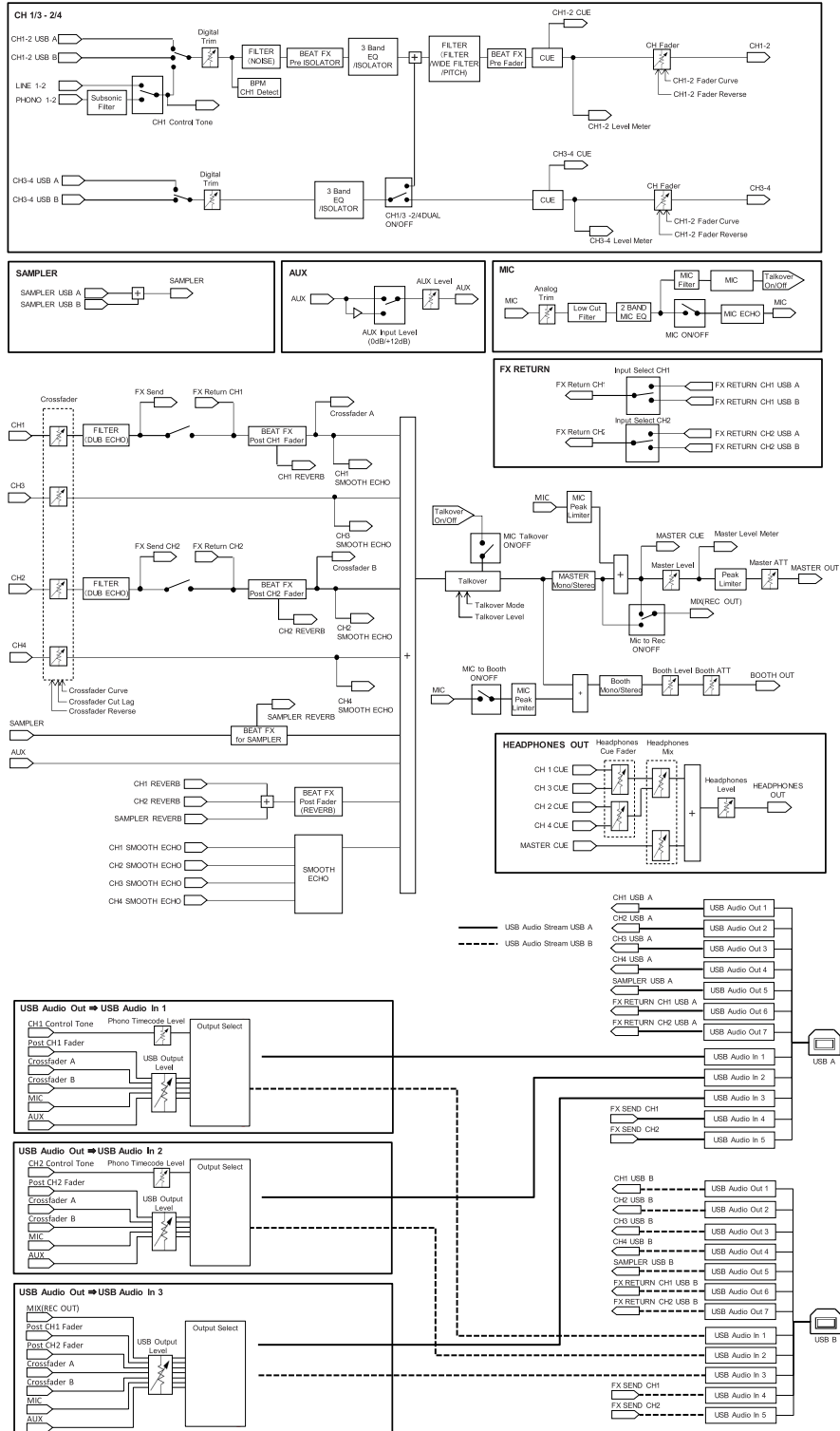

Additional information

Troubleshooting

If you think something is wrong with the unit, check the information below and refer to the [FAQ] for the DJM-S11 at the URL below.

pioneerdj.com/support/

- Inspect devices connected with the unit.
- The unit may restore proper operation after you turn it off and on.

If the problems continue, read the “Precautions for Use” and consult Authorized Service Company or your dealer.

LCD display

- Small black or shining points may appear on the LCD display. This is a phenomenon inherent to LCD displays and not a malfunction.
- When using the unit in cold places, the LCD display may be dark for a while after the power is turned on. Normal brightness will restore after a while.
- When the LCD display is exposed to direct sunlight, the light will reflect off it, making it difficult to see. Block the direct sunlight to improve visibility of the display.

Cleaning

Wipe with a dry soft cloth.

- Do not use organic solvents, acids or alkalis for cleaning.

Touch screen

- Operate the touch screen with your fingertip. Do not press it with excessive force.
- Do not operate the touch screen with hard and sharp-pointed objects such as a ballpoint pen, mechanical pencil, or sharp fingernail.

Trademarks and registered trademarks

- rekordbox™ is a trademark or registered trademark of AlphaTheta Corporation.
- Mac and macOS are trademarks of Apple Inc., registered in the U.S. and other countries.
- Windows is a registered trademark of Microsoft Corporation in the United States and other countries.
- ASIO is a trademark of Steinberg Media Technologies GmbH.
- Serato DJ Pro is a registered trademark of Serato Limited.

Other product, technology and company names, etc. mentioned herein are trademarks or registered trademarks of their respective owners.

Software license notice

The licenses for the open source software used on this player are shown below. For accuracy purposes, here we have included the original texts (in English).

Copyright © 2010 Texas Instruments Incorporated - <http://www.ti.com/>

Redistribution and use in source and binary forms, with or without modification, are permitted provided that the following conditions are met:

Redistributions of source code must retain the above copyright notice, this list of conditions and the following disclaimer.

Redistributions in binary form must reproduce the above copyright notice, this list of conditions and the following disclaimer in the documentation and/or other materials provided with the distribution.

Neither the name of Texas Instruments Incorporated nor the names of its contributors may be used to endorse or promote products derived from this software without specific prior written permission.

THIS SOFTWARE IS PROVIDED BY THE COPYRIGHT HOLDERS AND CONTRIBUTORS «AS IS» AND ANY EXPRESS OR IMPLIED WARRANTIES, INCLUDING, BUT NOT LIMITED TO, THE IMPLIED WARRANTIES OF MERCHANTABILITY AND FITNESS FOR A PARTICULAR PURPOSE ARE DISCLAIMED. IN NO EVENT SHALL THE COPYRIGHT OWNER OR CONTRIBUTORS BE LIABLE FOR ANY DIRECT, INDIRECT, INCIDENTAL, SPECIAL, EXEMPLARY, OR CONSEQUENTIAL DAMAGES (INCLUDING, BUT NOT LIMITED TO, PROCUREMENT OF SUBSTITUTE GOODS OR SERVICES; LOSS OF USE, DATA, OR PROFITS; OR BUSINESS INTERRUPTION) HOWEVER CAUSED AND ON ANY THEORY OF LIABILITY, WHETHER IN CONTRACT, STRICT LIABILITY, OR TORT (INCLUDING NEGLIGENCE OR OTHERWISE) ARISING IN ANY WAY OUT OF THE USE OF THIS SOFTWARE, EVEN IF ADVISED OF THE POSSIBILITY OF SUCH DAMAGE.

Cautions on copyrights

Recordings you have made are for your personal enjoyment and according to copyright laws may not be used without the consent of the copyright holder.

- Music recorded from CDs, etc., is protected by the copyright laws of individual countries and by international treaties. It is the full responsibility of the person who has recorded the music to ensure that it is used legally.
- When handling music downloaded from the Internet, etc., it is the full responsibility of the person who has downloaded the music to ensure that it is used in accordance with the contract concluded with the download site.

The specifications and design of this product are subject to change without notice.

© 2020 AlphaTheta Corporation. All rights reserved.

<DRI1653-A>