

Instruction Manual

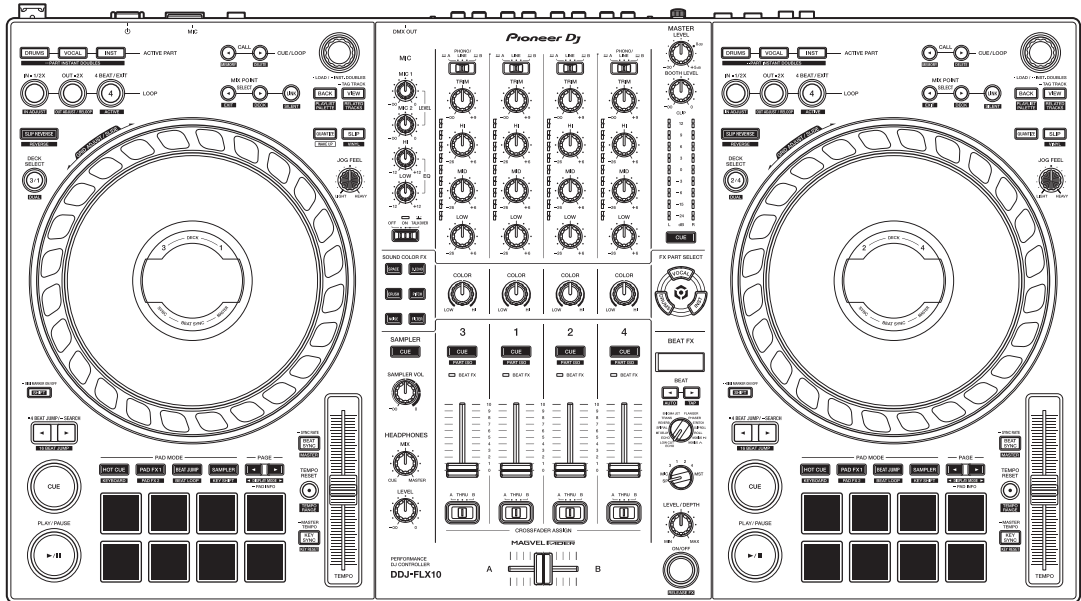

DJ Controller

DDJ-FLX10

pioneerdj.com/support/

rekordbox.com

serato.com

For FAQ and other support information for this product, visit the websites above.

Pioneer Dj

serato

How to read this manual

Thank you for choosing this Pioneer DJ product.

Be sure to read this manual, the Quick Start Guide and the Precautions for Use which are included with this product. These documents include important information that you should understand before using the unit. In particular, be sure to read the IMPORTANT SAFETY INSTRUCTIONS.

- In this manual, the names of buttons, knobs, and terminals that appear on the product, and the names of buttons, menus, etc. in the software on your PC/Mac, are indicated within square brackets ([]). (e.g. **[File]**, **[CUE]** button)
- Please note that the software screens and their specifications, as well as the external appearance and specifications of the hardware, are subject to change without notice.
- Please note that depending on the operating system version, web browser settings, etc. operation may differ from the ways described in this manual.
- Please note that the language on the screens of the software described in this manual may differ from the language on your screen.

Contents

How to read this manual	2
Before you start.....	5
What's in the box	5
User guides.....	5
DJ software.....	6
PC/Mac setup	8
Part names and functions	10
Top panel.....	10
Browse section	11
Deck section	14
On Jog Display (using rekordbox)	33
On Jog Display (using Serato DJ Pro).....	43
Mixer section.....	50
Effects section	54
Rear panel	58
Front panel.....	61
Connections.....	62
Connection examples	63
rekordbox.....	67
Installing rekordbox.....	67
Basic use	70
Advanced use	76
Changing the settings in rekordbox	107

Serato DJ Pro	114
Installing Serato DJ Pro	114
Basic use	117
Advanced use	124
Changing the settings	154
Launching Utilities mode.....	154
Setting Utility software	159
Additional information	165
Troubleshooting	165
LCD display	173
Signal flow	174
Specifications.....	175
Using the unit as a controller for other DJ applications	179
Trademarks and registered trademarks.....	180
Software license notice.....	181
Cautions on copyrights	183

Before you start

What's in the box

- AC adapter
- Power cord
- USB cable
- Warranty (for some regions)¹
- Quick Start Guide
- Precautions for Use
- Serato Pitch 'n Time DJ voucher²

¹ Only products in Europe.

Products in North America and Japan include warranty information in the Precautions for Use.

² The voucher codes needed to activate functions can't be reissued. Keep them in a safe place to be sure you don't lose them.

User guides

rekordbox Introduction, Instruction Manual

Refer to the rekordbox Introduction to find out how to set up rekordbox, and see the rekordbox Instruction Manual to find out how to use rekordbox.

rekordbox.com/manual

Serato DJ Pro software manual

Visit the Serato DJ Pro website.

serato.com/dj/pro/downloads

DJ software

rekordbox

- rekordbox is a complete DJ application you can use to manage your music and perform. And in Lighting mode, you can create lighting sequences to sync with your performances.
- Even if you don't have a paid subscription plan, you can use Performance mode by connecting this unit to your PC/Mac with rekordbox installed. This is called Hardware Unlock.
- You'll find details of the functions available via Hardware Unlock on **[Hardware Unlock]** under **[Support]** at rekordbox.com.
- The rekordbox software is not included with the unit. Download the software from the URL below.
rekordbox.com
- For information on the latest system requirements, compatibility, and supported operating systems of rekordbox, check **[System requirements]** under **[Support]** at rekordbox.com.
- Operation isn't guaranteed on all PC/Mac models, even if the system requirements are met.
- Depending on power-saving settings and other conditions of the PC/Mac, the CPU and hard disk may not provide sufficient processing capabilities. For laptops in particular, make sure the PC/Mac is in the best condition to provide constant high-level performance when using rekordbox (for example by keeping the AC power connected).
- To use the internet, you need a separate contract with an internet service provider, which you may have to pay for.
- Operating system support always assumes you're using the latest point release for that version.

Serato DJ Pro

Serato DJ Pro is DJ software from Serato Limited.

This unit unlocks the software, which you can download from the Serato website.

serato.com/dj/pro/downloads

- For information on the latest system requirements, compatibility, and supported operating systems of Serato DJ Pro, visit the website below.

serato.com/dj/pro/downloads

- Operation isn't guaranteed on all PC/Mac models, even if the system requirements are met.
- Depending on power-saving settings and other conditions of the PC/Mac, the CPU and hard disk may not provide sufficient processing capabilities. For laptops in particular, make sure the PC/Mac is in the best condition to provide constant high-level performance when using Serato DJ Pro (for example by keeping the AC power connected).

PC/Mac setup

To input or output your PC/Mac's audio to/from the unit, install the dedicated audio driver software and/or Setting Utility on your PC/Mac. If you install the audio driver software to your PC (Windows), Setting Utility will also be installed with the driver software.

If you use a Mac, install Setting Utility only.

- For information on the latest system requirements, compatibility, and supported operating systems, visit the URL below.

pioneerdj.com/support/

- Operation isn't guaranteed on all PC/Mac models, even if the system requirements are met.
- Operation isn't guaranteed when multiple units are connected to a PC/Mac.
- If a PC (Windows) without the dedicated audio driver software installed is connected to the unit, errors may occur on the PC.
- Malfunctions may occur due to incompatibility with other software installed on a PC/Mac.

Installation

❖ Notes on installation

- Turn the unit off and disconnect the USB cable connected to the unit and the PC/Mac before installation.
- Close all applications running on the PC/Mac before installation.
- You'll need admin rights to install the dedicated software to your PC/Mac.
- Read the License Agreement terms carefully before installation.
- If you quit the installation halfway through, perform the installation procedure from the beginning again.
- After the installation is complete, connect the PC/Mac to the unit.
- Operation isn't guaranteed on all PC/Mac models.

Downloading the dedicated software

- 1 Visit the URL below.
pioneerdj.com/support/
- 2 Click **[Software & firmware updates]**.
- 3 Click **[DDJ-FLX10]** under **[DJ CONTROLLER]**.
- 4 Click **[Drivers]**.
- 5 Click **[Download link]** and save the file.
 - Download the dedicated software to your PC/Mac.

Installing the dedicated software

- 1 Unzip the downloaded dedicated software.
- 2 Double-click the installation file.
 - Double-click “DDJ-FLX10_#.###.exe” if you’re using a PC (Windows), or “DDJ-FLX10_M_#.#.#.dmg” → “DDJ-FLX10SettingUtility.pkg” if you’re using a Mac (# indicates the version number of the software).
- 3 Read the Software end user license agreement carefully.
If you agree to the terms, mark the **[Agree]** check box and click **[OK]**.
 - If you don’t agree to the license agreement terms, click **[Disagree]** (for Mac)/**[Cancel]** (for Windows) to cancel the installation.
- 4 Follow the on-screen instructions to complete the installation.

Part names and functions

Top panel

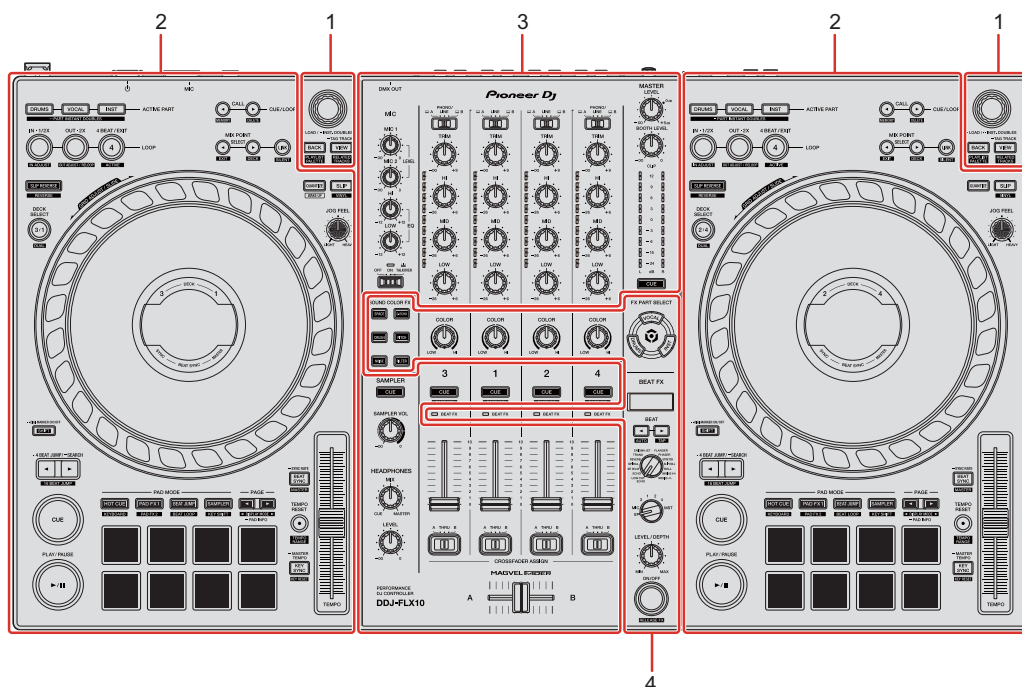

1 Browse section

Selects tracks and loads them to the decks.

2 Deck sections

Control each deck. There are knobs and buttons on the left side to control deck 1 and deck 3, and on the right side to control deck 2 and deck 4.

3 Mixer section

Controls the level adjustment for each channel, track mixing, etc.

4 Effects section

Controls the effects.

Browse section

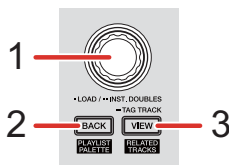

❖ Using rekordbox

1 Rotary selector

Turn:

Moves the cursor in rekordbox.

[SHIFT] + turn:

Enlarges or shrinks the enlarged waveform in rekordbox.

Turn to the right to enlarge, or the left to shrink it.

Press:

If the cursor is pointed to a track, the track loads onto the deck.

If the cursor is pointed to a playlist, the cursor moves to the track list.

If the cursor is pointed to a folder, the folder opens.

- When the playlist palette is displayed, the cursor will also move to the track list when the cursor is on a playlist in the playlist palette.
- The tree view, track list, and playlist palette are displayed in the browse section of rekordbox. For details on each, read the rekordbox Instruction Manual.

Press twice:

Loads the track from the deck that isn't playing onto the deck that is playing.

If you do this while the track is playing, it plays from the same position (Instant Doubles).

2 BACK button

Press:

Moves the cursor between the tree view and track list each time you press the button.

- When the playlist palette is displayed, the cursor will move between the tree view, track list, and a playlist in the playlist palette.
- The tree view, track list, and playlist palette are displayed in the browse section of rekordbox. For details on each, read the rekordbox Instruction Manual.

[SHIFT] + press:

Displays/hides the playlist palette.

3 VIEW button

Press:

Shrinks the deck display and enlarges the browse area. Press the button again to return to the original display status.

Hold:

Adds or deletes the selected track to/from **[Tag List]**.

[SHIFT] + press:

Moves the cursor into **[Related Tracks]** in the tree view.

❖ Using Serato DJ Pro

1 Rotary selector

Turn:

Moves the cursor up or down in the library or in the **[crates]** panel.

[SHIFT] + turn:

Enlarges or shrinks the detailed waveform on the On Jog Display.

Turn to the right to enlarge, or the left to shrink it.

Part names and functions

Press:

If the cursor is pointed to a track, the track loads onto the deck.

If the cursor is pointed to a library or **[crates]**, the cursor moves between the library and **[crates]** panels each time you press the button.

Press twice:

Loads the track from the deck that isn't playing onto the deck that is playing.

If you do this while the track is playing, it plays from the same position (Instant Doubles).

2 **BACK** button

Press:

Moves the cursor between the library and **[crates]** panel each time you press the button.

Hold:

Launches Utilities mode.

➡ Read more: Changing the settings (page 154)

[SHIFT] + press:

Loads a track onto the **[PREPARE]** panel.

3 **VIEW** button

Press:

Changes the screen layout of Serato DJ Pro.

[SHIFT] + press:

Changes the panel display each time you press the button.

Deck section

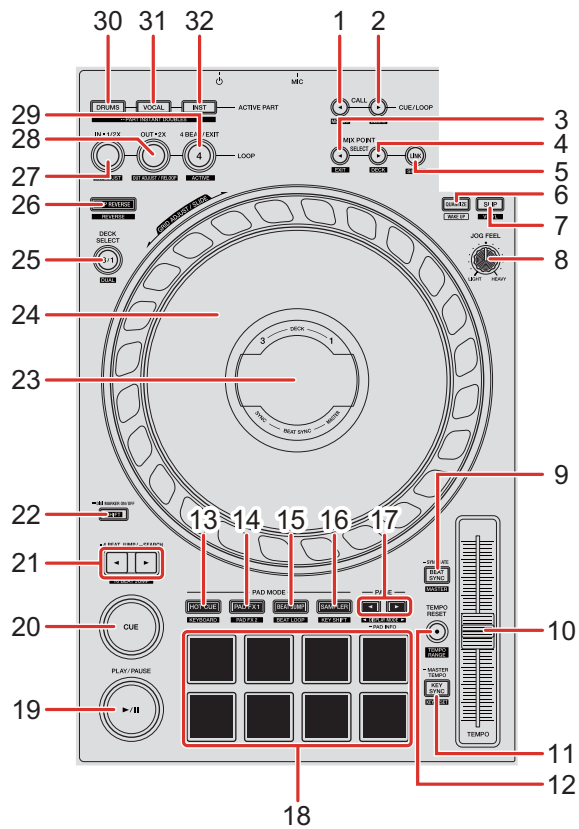

❖ Using rekordbox

1 CUE/LOOP CALL ◀ button

Press:

Selects and calls up the cue point or loop point.

[SHIFT] + press:

Saves the cue point or loop point.

2 CUE/LOOP CALL ▶ button

Press:

Selects and calls up the cue point or loop point.

[SHIFT] + press:

Deletes the cue point or loop point.

3 **MIX POINT SELECT ◀ button**

Press:

Selects a point to be mixed from a Hot Cue point or cue point set on the track that's loaded to the deck to be mixed.

[SHIFT] + press:

Cancels the setting for Mix Point Link.

4 **MIX POINT SELECT ▶ button**

Press:

Selects a point to be mixed from a Hot Cue point or cue point set on the track that's loaded to the deck to be mixed.

[SHIFT] + press:

Selects the deck to be mixed.

- This is enabled when using MIX POINT LINK.
- The deck that's already playing in rekordbox can be selected.

5 **MIX POINT LINK button**

Press:

Displays the Mix Point Link screen on the On Jog Display and you can start making settings for Mix Point Link.

➡ Read more: Using Mix Point Link (page 102)

[SHIFT] + press:

If you start playback with Mix Point Link, you can change the audio output from the beginning of the track to the mix point to mute (Silent setting).

To set Silent during the Mix Point Link setting, read: Using Mix Point Link (page 102)

6 QUANTIZE button

Press:

Turns the Quantize function on/off.

Press (during Standby mode):

Cancels Standby mode.

- You can only do this on the left deck.

[SHIFT] + press:

Hold the **[SHIFT]** button and tap the button to set the tempo of the respective deck in time with your tapping (Tap feature).

7 SLIP button

Press:

Turns Slip mode on/off.

[SHIFT] + press:

Turns Vinyl mode on/off.

8 JOG FEEL knob

Turn:

Adjusts the load applied (“weight”) when the jog wheel is turned.

Turn the knob clockwise to increase the load, or turn the knob counterclockwise to decrease the load.

9 BEAT SYNC button

Press:

Automatically synchronizes the tempo (BPM) and beatgrid with the deck set as the master.

Press (during Beat Sync):

Cancels Beat Sync.

Hold (during Beat Sync):

Sync Rate

Changes the BPM on the deck that's playing to the original, double, or half.

Part names and functions

[SHIFT] + press:

Sets the deck as the master.

10 TEMPO slider

Adjusts the playing speed of the track.

11 KEY SYNC button

Press:

Changes the key of the track to match the other deck.

[SHIFT] + press:

Changes the key of the track that's playing to the original key.

12 TEMPO RESET button

Press:

Returns the playback speed to the original speed, regardless of the position of the **[TEMPO]** slider.

[SHIFT] + press:

Switches the range of the **[TEMPO]** slider each time the button is pressed while holding the **[SHIFT]** button.

Switch between **[±6%]** → **[±10%]** → **[±16%]** → **[WIDE]** → **[±6%]**.

13 HOT CUE mode button

Press:

Enters Hot Cue mode.

➡ Read more: Using Hot Cues (page 78)

[SHIFT] + press:

Enters Keyboard mode.

➡ Read more: Using Keyboard mode (page 84)

14 PAD FX1 mode button

Press:

Enters Pad FX mode 1.

➡ Read more: Using Pad FX (page 80)

[SHIFT] + press:

Enters Pad FX mode 2.

➡ Read more: Using Pad FX (page 80)

15 BEAT JUMP mode button

Press:

Enters Beat Jump mode.

➡ Read more: Using Beat Jump (page 82)

[SHIFT] + press:

Enters Beat Loop mode.

➡ Read more: Using Beat Loop (page 85)

16 SAMPLER mode button

Press:

Enters Sampler mode.

➡ Read more: Using Sampler (page 82)

[SHIFT] + press:

Enters Key Shift mode.

➡ Read more: Using Key Shift (page 86)

17 PAGE ◀ button, PAGE ▶ button

Press:

Changes the pad page of each pad mode.

➡ Read more: Using the Performance Pads (page 78)

Hold:

Displays the function assigned to the pad on the On Jog Display.

[SHIFT] + press:

Switches information on the On Jog Display.

18 Performance Pads

Press:

You can use Performance Pads to trigger various features.

➔ Read more: Using the Performance Pads (page 78)

19 PLAY/PAUSE ►/|| button

Press:

Plays/pauses a track.

20 CUE button

Press:

Sets, calls up, and plays a cue point.

- Press the button when the track is paused to set the cue point.
- Press the button when the track is playing to return to the cue point and pause. (Back Cue)
- Press the button and hold it after the track returns to the cue point and playback will continue until you release the button. (Cue Point Sampler)

[SHIFT] + press:

Returns the playback position to the beginning of the track.

21 4 BEAT JUMP ◀ button, 4 BEAT JUMP ▶ button

Press:

Instantly moves the playback position by 4 beats without breaking the rhythm.

Hold:

Fast-forward or fast-reverse the track until you release the button.

[SHIFT] + press:

Instantly moves the playback position by 16 beats without breaking the rhythm.

22 SHIFT button

Press another button while holding the **[SHIFT]** button to use a different feature assigned to the button.

Press twice:

Switches between display and non-display of the Digital Marker on the On Jog Display.

23 On Jog Display

➡ Read more: On Jog Display (using rekordbox) (page 33)

24 Jog wheel

Turn the top when Vinyl mode is on:

Scratches the track.

Turn the outer section or turn the top when Vinyl mode is off:

Bends the pitch (Pitch Bend – slows down or speeds up the track).

[SHIFT] + turn the top:

Adjusts the beatgrid interval of the loaded track.

[SHIFT] + turn the side:

Slides the whole beatgrid of the loaded track to the left or right.

[4 BEAT JUMP ◀] or **[4 BEAT JUMP ▶]** + turn the top:

Fast-forward or fast-reverse the track with extra speed in the direction the wheel is turned.

25 DECK SELECT button

Press:

Switches the deck to be used.

[SHIFT] + press:

Turns Dual Deck mode on/off.

26 SLIP REVERSE button

Press:

Plays in reverse while you hold the button and returns to normal playback when you release it.

- Normal playback continues in the background during reverse playback, then normal playback resumes from the position it's reached when you release the button.
- Even if you keep holding the button, reverse playback will automatically cancel after 8 beats, then normal playback resumes from the position it's reached.

[SHIFT] + press:

Plays in reverse.

Reverse playback cancels when you press the button while holding the **[SHIFT]** button again, and normal playback resumes.

27 LOOP IN, 1/2X button

Press:

Sets the loop in point.

Press (during loop playback):

Halves the loop playback length.

- When paused at the loop in point, the loop playback length isn't changed.

[SHIFT] + press (during loop playback):

Adjusts the loop in point using the jog wheel.

28 LOOP OUT, 2X button

Press:

Sets the loop out point, and loop playback begins.

Press (during loop playback):

Doubles the loop playback length.

Part names and functions

[SHIFT] + press:

Playback returns to the previously set loop in point and loop playback resumes.

[SHIFT] + press (during loop playback):

Adjusts the loop out point using the jog wheel.

29 4 BEAT/EXIT button

Press:

Starts Auto Beat Loop of 4 beats.

Press (during loop playback):

Cancels loop playback.

[SHIFT] + press:

Switches the active/non-active status of the loop. (Active Loop)

- During playback, the loop nearest the playback position is set to active.
- When you call up the loop, the called-up loop is set to active or non-active.

30 ACTIVE PART DRUMS button

Press:

(When Mute is set), turns muting of the Drums part on/off.

(When Solo is set), outputs only the Drums part. Press the button again to output all parts.

- You can set the **[Preferences]** > **[Extensions]** > **[TRACK SEPARATION]** tab > **[ACTIVE PART setting]** in rekordbox.

[SHIFT] + press twice:

Part Instant Doubles

You can duplicate a track loaded on a deck so it plays on the other deck from exactly the same point.

Press the button twice while holding down the **[SHIFT]** button on the deck where you want the duplicate track to start playing.

The deck you pressed the button only plays the Drums part, and the other deck mutes the Drums part.

31 ACTIVE PART VOCAL button

Press:

(When Mute is set), turns muting of the Vocal part on/off.

(When Solo is set), outputs only the Vocal part. Press the button again to output all parts.

- You can set the **[Preferences] > [Extensions] > [TRACK SEPARATION] tab > [ACTIVE PART setting]** in rekordbox.

[SHIFT] + press twice:

Part Instant Doubles

You can duplicate a track loaded on a deck so it plays on the other deck from exactly the same point.

Press the button twice while holding down the **[SHIFT]** button on the deck where you want the duplicate track to start playing.

The deck you pressed the button only plays the Vocal part, and the other deck mutes the Vocal part.

32 ACTIVE PART INST button

Press:

(When Mute is set), turns muting of the INST part on/off.

(When Solo is set), outputs only the INST part. Press the button again to output all parts.

- You can set the **[Preferences] > [Extensions] > [TRACK SEPARATION] tab > [ACTIVE PART setting]** in rekordbox.

[SHIFT] + press twice:

Part Instant Doubles

You can duplicate a track loaded on a deck so it plays on the other deck from exactly the same point.

Press the button twice while holding down the **[SHIFT]** button on the deck where you want the duplicate track to start playing.

The deck you pressed the button only plays the INST part, and the other deck mutes the INST part.

❖ Using Serato DJ Pro

1 CUE/LOOP CALL ◀ button

Press:

Selects the loop slot.

[SHIFT] + press:

Locks the loop slot.

2 CUE/LOOP CALL ▶ button

Press:

Selects the loop slot.

[SHIFT] + press:

Deletes the loop slot.

3 MIX POINT SELECT ◀ button

Press:

Lowers the key of the track.

4 MIX POINT SELECT ▶ button

Press:

Raises the key of the track.

[SHIFT] + press:

Selects another deck displayed on the Waveform mode screen of the On Jog Display.

5 MIX POINT LINK button

Press:

Turns the Key Lock function on/off.

6 QUANTIZE button

Press:

Turns the Quantize function on/off.

Press (during Standby mode):

Cancels Standby mode.

- You can only do this on the left deck.

[SHIFT] + press:

Hold the **[SHIFT]** button and tap the button to set the tempo of the respective deck in time with your tapping (Tap feature).

7 SLIP button

Press:

Turns Slip mode on/off.

[SHIFT] + press:

Turns Vinyl mode on/off.

8 JOG FEEL knob

Turn:

Adjusts the load ("weight") applied when you turn the jog wheel.

Turn the knob clockwise to increase the load, or turn it counterclockwise to decrease the load.

9 BEAT SYNC button

Press:

The tempo (BPM) and beatgrid of multiple decks are automatically synchronized.

[SHIFT] + press:

Cancels Sync mode.

10 TEMPO slider

Adjusts the playing speed of the track.

11 KEY SYNC button

Press:

Changes the key of the track to match the other deck.

[SHIFT] + press:

Changes the key of the track on the deck that is playing to the original key.

12 TEMPO RESET button

Press:

Returns the playback speed to the original speed, regardless of the position of the **[TEMPO]** slider.

[SHIFT] + press:

Switches the range of the **[TEMPO]** slider each time the button is pressed while holding the **[SHIFT]** button.

Switch between **[±6%]** → **[±10%]** → **[±16%]** → **[±100%]** → **[±6%]**.

13 HOT CUE mode button

Press:

Enters Hot Cue mode.

➤ Read more: Using Hot Cues (page 126)

Hold:

Enters Saved Flip mode.

➤ Read more: Using Saved Flip (page 134)

[SHIFT] + press:

Enters Pitch Play mode.

➤ Read more: Using Pitch Play (page 129)

14 PAD FX1 mode button

Press:

Enters Pad FX mode.

➤ Read more: Using Pad FX (page 127)

[SHIFT] + press:

Enters Roll mode.

➡ Read more: Using Roll (page 131)

15 BEAT JUMP mode button

Press:

Enters Beat Jump mode.

➡ Read more: Using Beat Jump (page 127)

[SHIFT] + press:

Enters Auto Loop mode.

➡ Read more: Using Auto Loop (page 132)

16 SAMPLER mode button

Press:

Enters Sampler mode.

➡ Read more: Using Sampler (page 128)

[SHIFT] + press:

Enters Key Shift mode.

➡ Read more: Using Key Shift (page 133)

17 PAGE ◀ button, PAGE ▶ button

Press or **[SHIFT]** + press:

Adjusts the parameter of each pad mode.

➡ Read more: Using the Performance Pads (page 126)

Hold:

Displays the function assigned to the pad on the On Jog Display.

[SHIFT] + hold:

Switches information on the On Jog Display.

18 Performance Pads

Press:

You can use Performance Pads to trigger various features.

➡ Read more: Using the Performance Pads (page 126)

19 PLAY/PAUSE ►/|| button

Press:

Plays/pauses a track.

[SHIFT] + press:

Returns to the temporary cue point and playback starts (Stutter).

20 CUE button

Press:

Sets, calls up, and plays a cue point.

- Press the button when the track is paused to set the cue point.
- Press the button when the track is playing to return to the cue point and pause (Back Cue).
- Press the button and hold it after the track returns to the cue point and playback will continue until you release the button (Cue Point Sampler).

[SHIFT] + press:

Returns the playback position to the beginning of the track.

21 4 BEAT JUMP ◀ button, 4 BEAT JUMP ▶ button

Press:

Instantly moves the playback position by 4 beats without breaking the rhythm.

Hold:

Fast-forward or fast-reverse the track until you release the button.

[SHIFT] + press:

Instantly moves the playback position by 16 beats without breaking the rhythm.

22 SHIFT button

Press another button while holding the **[SHIFT]** button to use a different feature assigned to the button.

Press twice:

Switches between display and non-display of the Digital Marker on the On Jog Display.

23 On Jog Display

➔ Read more: On Jog Display (using Serato DJ Pro) (page 43)

24 Jog wheel

Turn the top when Vinyl mode is on:

Scratches the track.

Turn the outer section or turn the top when Vinyl mode is off:

Bends the pitch (Pitch Bend – slows down or speeds up the track).

[SHIFT] + turn the top:

Adjusts the beatgrid interval of the loaded track.

[SHIFT] + turn the side:

Slides the whole beatgrid of the loaded track to the left or right.

[4 BEAT JUMP ◀] or **[4 BEAT JUMP ▶]** + turn the top:

Fast-forward or fast-reverse the track with extra speed in the direction you turn the jog wheel (Skip mode).

25 DECK SELECT button

Press:

Switches the deck to be used.

[SHIFT] + press:

Turns Dual Deck mode on/off.

26 SLIP REVERSE button

Press:

Plays in reverse while you hold the button and returns to normal playback when you release it.

- Normal playback continues in the background during reverse playback, then normal playback resumes from the position it's reached when you release the button.
- Even if you hold the button, reverse playback automatically cancels after 8 beats, and normal playback resumes from the position it's reached.

[SHIFT] + press:

Plays in reverse.

Reverse playback cancels when you press the button while holding the **[SHIFT]** button again, and normal playback resumes.

27 LOOP IN, 1/2X button

Press:

Sets the loop in point.

Press (during loop playback):

Halves the loop playback length.

- When paused at the loop in point, the loop playback length isn't changed.

[SHIFT] + press (during loop playback):

Adjusts the loop in point using the jog wheel.

28 LOOP OUT, 2X button

Press:

Sets the loop out point, and loop playback begins.

Press (during loop playback):

Doubles the loop playback length.

[SHIFT] + press:

Playback returns to the previously set loop in point and loop playback resumes.

Part names and functions

[SHIFT] + press (during loop playback):

Adjusts the loop out point using the jog wheel.

29 4 BEAT/EXIT button

Press:

Starts Auto Beat Loop of 4 beats.

Press (during loop playback):

Cancels loop playback.

[SHIFT] + press:

Switches the active/non-active status of the loop.

30 ACTIVE PART DRUMS button

Press:

Turns muting of the Drums Stem on/off.

[SHIFT] + press twice:

You can duplicate a track loaded on a deck so it plays on the other deck from exactly the same point.

Press the button twice while holding down the **[SHIFT]** button on the deck where you want the duplicate track to start playing.

The deck you pressed the button only plays the Drums Stem, and the other deck mutes the Drums Stem.

31 ACTIVE PART VOCAL button

Press:

Turns muting of the Vocal Stem on/off.

[SHIFT] + press twice:

You can duplicate a track loaded on a deck so it plays on the other deck from exactly the same point.

Press the button twice while holding down the **[SHIFT]** button on the deck where you want the duplicate track to start playing.

Part names and functions

The deck you pressed the button only plays the Vocal Stem, and the other deck mutes the Vocal Stem.

32 ACTIVE PART INST button

Press:

Turns muting of the Bass and Melody Stems on/off.

[SHIFT] + press twice:

You can duplicate a track loaded on a deck so it plays on the other deck from exactly the same point.

Press the button twice while holding down the **[SHIFT]** button on the deck where you want the duplicate track to start playing.

The deck you pressed the button only plays the Bass and Melody Stems, and the other deck mutes the Bass and Melody Stems.

On Jog Display (using rekordbox)

When loading a track from DJ software to a deck, the On Jog Display shows various track information.

If you're using rekordbox, press the **[PAGE ◀]** button or **[PAGE ▶]** button while holding the **[SHIFT]** button to switch information on the On Jog Display between Deck Info mode, Waveform mode, Artwork Display, and DJ Logo Display.

Deck Info mode

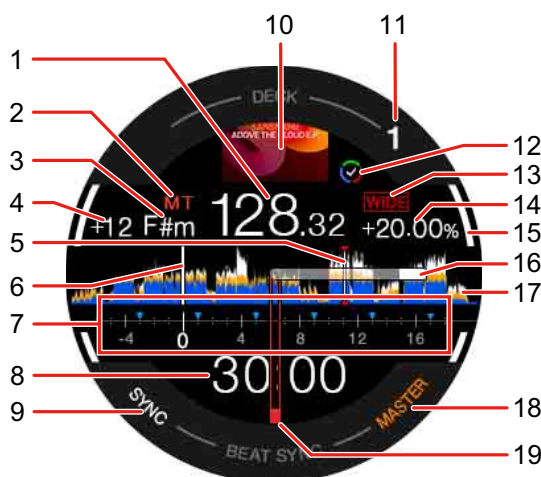

1 **BPM**

Displays the BPM of the track.

2 **Master tempo**

Shows when the master tempo is turned on.

3 **Key**

Shows the current key of the track.

4 **Key change amount**

Shows the amount of change between the original key and the current key of the track.

5 Cue / Loop / Hot Cue points

Shows the set cue points, loop points, and Hot Cue points as markers.

6 Playback position

Shows the current playback position.

7 Cue scope

Shows the cue points, loop points, and Hot Cue points set in the section from 4 bars before to 16 bars after the current playback position as markers. Also, 4-bar units based on positions of the set or called-up cue / loop points are displayed as markers.

8 Time (minutes, seconds)

Indicates the remaining time or elapsed time.

You can change the display via the settings in **[Preferences]** in rekordbox.

➡ Read: Changing the settings in rekordbox (page 107)

- Shows loop beats during loop playback.

9 SYNC

Lights up when Beat Sync is turned on.

10 Artwork

Displays the track artwork.

11 Deck number

Indicates the current playing deck.

12 Track Separation status

Lights up when Track Separation of the loaded track is complete.

13 Playing speed adjustment range

Displays the adjustable range based on the original playing speed of the track.

14 Playing speed

The value changes according to the position of the **[TEMPO]** slider.

15 On Air

Indicates the On Air status for the deck you're using.

Lights up in white when playing deck 1 or deck 2, and lights up in blue when playing deck 3 or deck 4.

16 Digital Marker

Shows the current playback position. Rotates during playback, and stops when the deck is paused.

- Press the **[SHIFT]** button twice to switch between display and non-display.
- The default setting is non-display.

17 Waveform

Displays the waveform.

You can switch the color and format (**[Full Waveform]** or **[Half Waveform]**) according to the setting in **[Preferences] > [View] > [Waveform]** in rekordbox. For information about settings in rekordbox, read the rekordbox Instruction Manual.

18 MASTER

Lights up when the deck is set as the master.

19 Cue point

Shows the position of the set or called-up cue point.

Part names and functions

Waveform mode



1 BPM

Displays the BPM of the track.

2 Master tempo

Shows when the master tempo is turned on.

3 Key

Shows the current key of the track.

4 Key change amount

Shows the amount of change between the original key and the current key of the track.

5 Cue / Loop / Hot Cue points

Shows the set cue points, loop points, and Hot Cue points as markers.

6 Playback position

Shows the current playback position.

7 Deck number (deck for mixing)

Indicates the deck number of the waveform for mixing.

8 Time (minutes, seconds)

Indicates the remaining time or elapsed time.

You can change the display via the settings in **[Preferences]** in rekordbox.

➡ Read: Changing the settings in rekordbox (page 107)

- Shows loop beats during loop playback.

9 SYNC

Lights up when Beat Sync is turned on.

10 Artwork

Displays the track artwork.

11 Deck number

Indicates the current playing deck.

12 Track Separation status

Lights up when Track Separation of the loaded track is complete.

13 Playing speed adjustment range

Displays the adjustable range based on the original playing speed of the track.

14 Playing speed

The value changes according to the position of the **[TEMPO]** slider.

15 On Air

Indicates the On Air status for the deck you're using.

Lights up in white when playing deck 1 or deck 2, and lights up in blue when playing deck 3 or deck 4.

16 Digital Marker

Shows the current playback position. Rotates during playback, and stops when the deck is paused.

- Press the **[SHIFT]** button twice to switch between display and non-display.
- The default setting is non-display.

Part names and functions

17 Enlarged waveform (playing deck)

Displays the enlarged waveform of the playing deck.

18 Enlarged waveform (deck for mixing)

Displays the enlarged waveform of the track on the deck for mixing.

19 MASTER

Lights up when the deck is set as the master.

20 Cue point

Shows the position of the set or called-up cue point.

Part names and functions

❖ To display Mix Point Link

When you press the **[MIX POINT SELECT ◀]** button, **[MIX POINT SELECT ▶]** button, or **[MIX POINT LINK]** button, Mix Point Link information appears.

➡ Read: Using Mix Point Link (page 102)



1 Playback position (playing deck)

Indicates the current playback position of the track on the playing deck.

2 Playback start time

After setting Mix Point Link, the remaining time to start playback of the next track will flash.

When the time reaches 0:00, this disappears.

3 Playback position (deck for mixing)

Indicates the current playback position of the track on the deck for mixing.

4 Mix Point Link position

(When Mix Point Link is set), displays the Mix Point Link position in the center of the waveform.

5 Mix Point Link status

This indicator appears when Mix Point Link is turned on.

Artwork Display



1 Artwork

Displays the track artwork.

2 SYNC

Lights up when Beat Sync is turned on.

3 Deck number

Indicates the current playing deck.

4 On Air

Indicates the On Air status of the deck you're using.

Lights up in white when playing deck 1 or deck 2, and lights up in blue when playing deck 3 or deck 4.

5 Digital Marker

Shows the current playback position. Rotates during playback, and stops when the deck is paused.

- Press the **[SHIFT]** button twice to switch between display and non-display.
- The default setting is non-display.

6 MASTER

Lights up when the deck is set as the master.

Part names and functions

7 Cue point

Shows the position of the set or called-up cue point.

DJ Logo Display



1 DJ Logo

Displays the DJ Logo.

- You can change the DJ Logo in **[DJ LOGO DISPLAY]** of the Setting Utility (page 159).

2 Cue point

Shows the position of the set or called-up cue point.

3 SYNC

Lights up when Beat Sync is turned on.

4 Deck number

Indicates the current playing deck.

5 On Air

Indicates the On Air status for the deck you're using.

Lights up in white when playing deck 1 or deck 2, and lights up in blue when playing deck 3 or deck 4.

Part names and functions

6 Digital Marker

Shows the current playback position. Rotates during playback, and stops when the deck is paused.

- Press the **[SHIFT]** button twice to switch between display and non-display.
- The default setting is non-display.

7 MASTER

Lights up when the deck is set as the master.

❖ To display the pad functions

When you press and hold down the **[PAGE ◀]** button or **[PAGE ▶]** button, information about the functions assigned to the Performance Pads shows. When you release the button, the display returns to the previous screen.

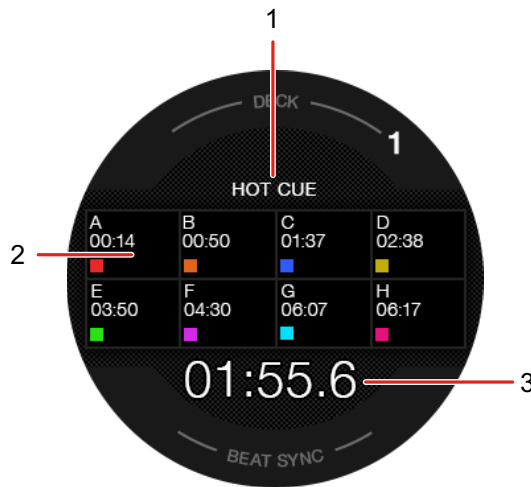

1 Pad mode

Indicates the current pad mode.

2 Pad function

Shows the function name, parameter, and color information assigned to the pad.

3 Time (minutes, seconds)

Indicates the remaining time or elapsed time.

On Jog Display (using Serato DJ Pro)

When loading a track from DJ software to a deck, the On Jog Display shows various track information. If you're using Serato DJ Pro, press the **[PAGE ◀]** button or **[PAGE ▶]** button while holding the **[SHIFT]** button to switch information on the On Jog Display between Virtual Deck mode, Waveform mode, Artwork Display, and DJ Logo Display.

Virtual Deck mode



1 BPM

Displays the BPM of the track.

2 Playing speed

The value changes according to the position of the **[TEMPO]** slider.

3 Loop

Shows the loop beat value. During loop playback, this displays in blue.

4 Elapsed time

5 Remaining time

6 SYNC

Lights up when Sync is turned on.

7 Deck number

Indicates the current playing deck.

8 Playing speed adjustment range

Displays the adjustable range based on the original playing speed of the track.

9 Key lock

Displays this symbol when Key Lock is turned on.

10 Key

Shows the current key of the track.

11 Key change amount

Shows the amount of change between the original key and the current key of the track.

12 Selected deck

Lights up in white when playing deck 1 or deck 2, and lights up in blue when playing deck 3 or deck 4.

13 Hot Cue

Shows the nearest Hot Cue point from the current playback position.

- You can display the Hot Cue information similar to the virtual deck of Serato DJ Pro by setting **[Display HOT CUE INDICATOR]** in the Setting Utility (page 159).

14 Digital Marker

Shows the current playback position. Rotates during playback, and stops when the deck is paused.

- Press the **[SHIFT]** button twice to switch between display and non-display.
- The default setting is non-display.

15 Playback position

Shows the current playback position. Rotates during playback, and stops when the deck is paused.

Waveform mode



1 Loop

Shows the loop beat value. During loop playback, this displays in blue.

2 Playing speed

The value changes according to the position of the **[TEMPO]** slider.

3 Selected deck

Lights up in white when playing deck 1 or deck 2, and lights up in blue when playing deck 3 or deck 4.

4 Playback position

Shows the current playback position.

5 Detailed waveform

Displays the detailed waveform near the current playback position.

- To enlarge or shrink the detailed waveform, turn the rotary selector while holding the **[SHIFT]** button.

6 Deck number (deck for mixing)

Indicates the deck number of the waveform for mixing.

7 SYNC

Lights up when the Sync function is turned on.

8 Key

Shows the current key of the track.

9 BPM

Displays the BPM of the track.

10 Deck number

Indicates the current playing deck.

11 Playing speed adjustment range

Displays the adjustable range based on the original playing speed of the track.

12 Key lock

Displays this symbol when Key Lock is turned on.

13 Waveform (deck for mixing)

Displays the waveform of the track on the deck for mixing.

14 Digital Marker

Shows the current playback position. Rotates during playback, and stops when the deck is paused.

- Press the **[SHIFT]** button twice to switch between display and non-display.
- The default setting is non-display.

15 Time

Indicates the remaining time or elapsed time.

You can change the display setting in **[Time Mode]** in the Setting Utility (page 159).

Artwork Display



1 Artwork

Displays the artwork.

2 SYNC

Lights up when the Sync function is turned on.

3 Deck number

Indicates the current playing deck.

4 Selected deck

Lights up in white when playing deck 1 or deck 2, and lights up in blue when playing deck 3 or deck 4.

5 Digital Marker

Shows the current playback position. Rotates during playback, and stops when the deck is paused.

- Press the **[SHIFT]** button twice to switch between display and non-display.
- The default setting is non-display.

DJ Logo Display



1 DJ Logo

Displays the DJ Logo.

- You can change the DJ Logo in **[DJ LOGO DISPLAY]** in the Setting Utility (page 159).

2 SYNC

Lights up when the Sync function is turned on.

3 Deck number

Indicates the current playing deck.

4 Selected deck

Lights up in white when playing deck 1 or deck 2, and lights up in blue when playing deck 3 or deck 4.

5 Digital Marker

Shows the current playback position. Rotates during playback, and stops when the deck is paused.

- Press the **[SHIFT]** button twice to switch between display and non-display.
- The default setting is non-display.

Part names and functions

❖ To display the pad functions

When you press and hold down the **[PAGE ◀]** button or **[PAGE ▶]** button, information about the functions assigned to the Performance Pads shows. When you release the button, the display returns to the previous screen.

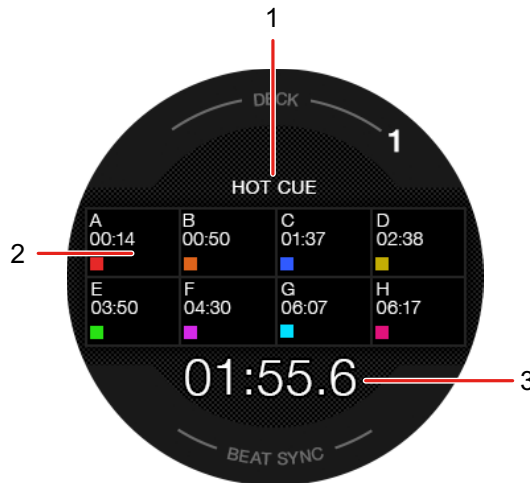

1 Pad mode

Indicates the current pad mode.

2 Pad function

Shows the function name, parameter, and color information assigned to the pad.

3 Time (minutes, seconds)

Indicates the remaining time or elapsed time.

Mixer section

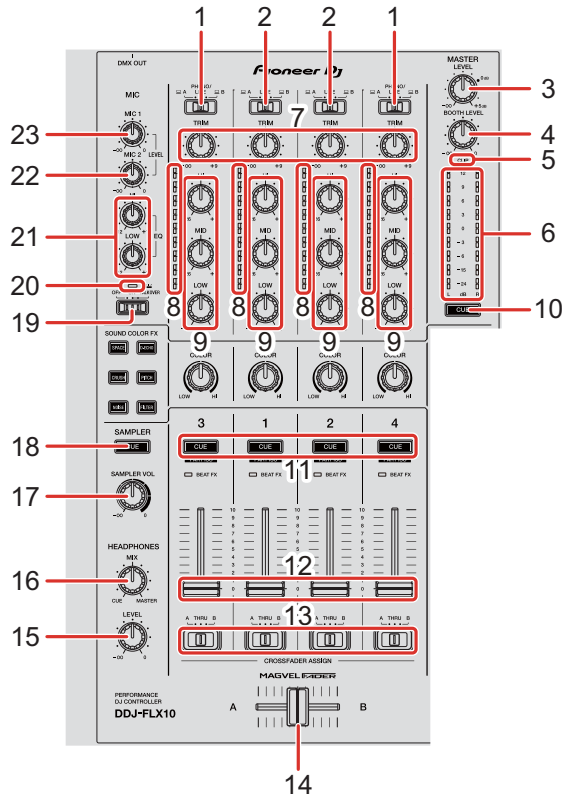

1 A, B switches

Selects the input source of each channel.

- [A] or [B]: Select to use a track loaded onto a deck.
 - [**PHONO/LINE**]: Select to use a phono-level (MM cartridge) output device such as a turntable connected to the [**LINE/PHONO**] input terminals.
- ➡ Read more: Using external inputs (page 105)(page 152)

2 A, B switches

Selects the input source of each channel.

- [A] or [B]: Select to use a track loaded onto a deck.
 - [**LINE**]: Select to use a line-level output device (multi player, etc.) connected to the [**LINE**] input terminals.
- ➡ Read more: Using external inputs (page 105)(page 152)

Part names and functions

3 MASTER LEVEL knob

Adjusts the volume of the master output sound.

4 BOOTH LEVEL knob

Adjusts the volume of the sound output from the **[BOOTH]** output terminals.

5 CLIP indicator

Flashes when the output level is too high.

- Slow flashing: Occurs just before the distortion of sound begins.
- Fast flashing: Occurs when the sound is distorted.

6 Master level indicator

Indicates the volume of the master output sound.

7 TRIM knobs

Adjust the volume of each channel's sound.

8 Channel level indicators

Indicate the volume of the sound of the respective channels before it passes through the channel faders.

9 EQ (HI, MID, LOW) knobs

For EQ mode, increase or decrease the relevant frequency for each channel.

For Part ISO mode, adjust the volume of each part (Stem).

For rekordbox, adjust the volume of the INST part with the EQ **[HI]** knob, the Vocal part with the EQ **[MID]** knob, and the Drums part with the EQ **[LOW]** knob.

- You can change the part to be adjusted by setting the **[Preferences]** > **[Extensions]** > **[TRACK SEPARATION]** > **[Layout]** in rekordbox.

For Serato DJ Pro, adjust the volume of the Vocal Stem with the EQ **[HI]** knob, the Bass and Melody Stems with the EQ **[MID]** knob, and the Drums Stem with the EQ **[LOW]** knob.

For information on changing the mode, see: 11. Headphones CUE buttons (channel)

10 Headphones CUE button (master)

Press:

Plays the master sound through your headphones.

11 Headphones CUE buttons (channel)

Press:

Play the sound of the relevant channel through your headphones.

[SHIFT] + press:

Switches between EQ mode and Part ISO mode for the EQ knobs on the channels that are controlling DJ software.

➡ See: 9 EQ (HI, MID, LOW) knobs

12 Channel faders

Adjust the volume of the sound for each channel.

13 Crossfader assign switches

Assign the channel output to the crossfader.

[A]: Assigns output to **[A]** (left) of the crossfader.

[B]: Assigns output to **[B]** (right) of the crossfader.

[THRU]: Select this when you don't want to use the crossfader. (The signals don't pass through the crossfader.)

14 Crossfader

Outputs sound assigned by the crossfader assign switches.

15 HEADPHONES LEVEL knob

Adjusts the volume of the headphones sound.

16 HEADPHONES MIX knob

Adjusts the monitor volume balance between sounds from the channels which have the headphones **[CUE]** button pressed, and the master channel.

17 SAMPLER VOL knob

Adjusts the volume of the sampler sound.

18 SAMPLER CUE button

Outputs the sampler sound from the headphones.

- When using Serato DJ Pro, set **[Sample Player Output Select]** to **[A]** in Serato DJ Pro.

19 MIC OFF, ON, TALKOVER switch

Turns the microphone on/off.

➡ Read: Using a microphone (page 104)(page 151)

20 MIC (microphone) indicator

➡ Read: Using a microphone (page 104)(page 151)

21 MIC EQ (HI, LOW) knobs

Adjust the sound from the **[MIC 1]** and **[MIC 2]** input terminals.

22 MIC2 LEVEL knob

Adjusts the volume of sound from the **[MIC 2]** input terminal.

23 MIC1 LEVEL knob

Adjusts the volume of sound from the **[MIC 1]** input terminal.

Don't forcibly pull out the channel fader and crossfader knobs. These knobs are hard to pull out and may break if pulled with force.

Effects section

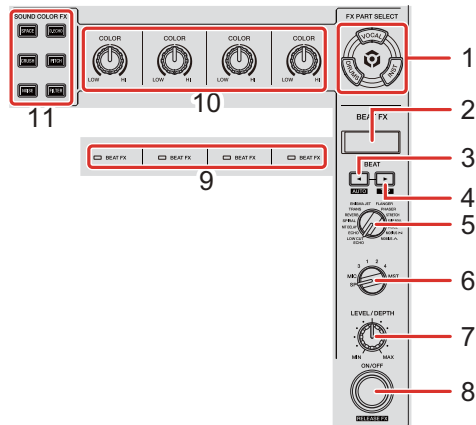

❖ Using rekordbox

1 FX PART SELECT (VOCAL, DRUMS, INST) buttons

Press:

Select a part to be applied with an effect when using Beat FX or Sound Color FX.

The effect applies to the parts which are lit.

- For sound from the external inputs, microphone sound, and sampler sound, the effect applies to all parts, even if the buttons aren't lit.

2 Effects section display

Displays the effect name, BPM, parameter, etc.

3 BEAT ◀ button

Press:

Decreases the number of beats for synchronizing the Beat FX sound each time the button is pressed.

[SHIFT] + press:

Sets the Beat FX Tempo mode to BPM Auto mode. The track's BPM is used as the basis for the Beat FX tempo.

4 **BEAT ► button**

Press:

Increases the number of beats for synchronizing the Beat FX sound each time the button is pressed.

[SHIFT] + press:

Sets the Beat FX Tempo mode to BPM Tap mode. The BPM used as the basis for Beat FX is set in time with your tapping of the button.

5 **BEAT FX select knob**

Changes the Beat FX.

6 **BEAT FX CH select knob**

Changes the channel that Beat FX will be applied to.

7 **BEAT FX LEVEL/DEPTH knob**

Adjusts the parameter of Beat FX.

8 **BEAT FX ON/OFF button**

Press:

Turns Beat FX on/off.

[SHIFT] + press:

Turns Release FX on/off.

9 **BEAT FX indicators**

Light up for the channel selected with the BEAT FX CH select knob.

When [MST] is selected, the indicators of all channels light up.

When Beat FX is on, the indicator flashes on the channel to which the effect is applied.

10 **COLOR knobs**

Change the parameter of Sound Color FX for each channel.

11 SOUND COLOR FX buttons

Turn Sound Color FX on/off.

➡ Read: Using Sound Color FX (page 99)

❖ Using Serato DJ Pro

1 FX PART SELECT (VOCAL, DRUMS, INST) buttons

Press:

Select a Stem to be applied with an effect when using Beat FX or Sound Color FX.

The effect applies to the Stems which are lit.

- For sound from the external inputs, microphone sound, and sampler sound, the effect applies to all Stems, even if the buttons aren't lit.

2 Effect section display

Displays the effect name, BPM, parameter, etc.

3 BEAT ◀ button

Press:

Decreases the number of beats for synchronizing the FX sound each time the button is pressed.

[SHIFT] + press:

Sets the FX Tempo mode to BPM Auto mode. The track's BPM is used as the basis for the FX tempo.

4 BEAT ▶ button

Press:

Increases the number of beats for synchronizing the FX sound each time the button is pressed.

[SHIFT] + press:

Sets the FX Tempo mode to BPM Tap mode. The BPM used as the basis for FX is set in time with your tapping of the button.

Part names and functions

5 **BEAT FX select knob**

Changes the FX.

6 **BEAT FX CH select knob**

Changes the channel that the effect will be applied to.

7 **BEAT FX LEVEL/DEPTH knob**

Adjusts the parameter of FX.

8 **BEAT FX ON/OFF button**

Press:

Turns FX on/off.

9 **BEAT FX indicators**

Light up for the channel selected with the BEAT FX CH select knob.

When **[MST]** is selected, the indicators of all channels light up.

When FX is turned on, the indicator flashes on the channel to which the effect is applied.

10 **COLOR knobs**

Change the parameter of Sound Color FX for each channel.

11 **SOUND COLOR FX buttons**

Turn Sound Color FX on/off.

➡ Read: Using Sound Color FX (page 148)

Rear panel

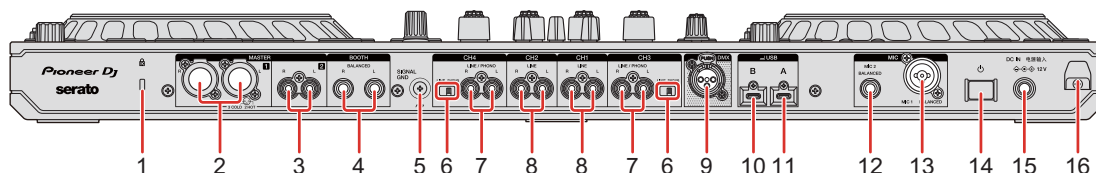

1 Kensington security slot

Connection for a cable lock for security.

2 MASTER 1 output terminals (balanced XLR)

Connection for analog input terminals of a power amplifier, etc.

- Be sure to use these terminals as balanced outputs. If you use an XLR to RCA converter cable (or a converter adapter), etc. to connect to the unbalanced input (RCA, etc.), sound quality may decrease or unwanted noise may occur.
- Be careful not to accidentally insert the power cord plug of another unit or device into any of these terminals.
- Never connect devices capable of supplying phantom power to these terminals.

3 MASTER 2 output terminals (RCA pin jack type)

Connection for analog input terminals of a power amplifier, etc.

- To connect to a balanced input (RCA, etc.), use the **[MASTER 2]** output terminals.

4 BOOTH output terminals (1/4" / 6.35 mm, TRS)

Outputs for a booth monitor.

- Be sure to use these terminals as balanced outputs. If you connect them to an unbalanced input, sound quality may decrease or unwanted noise may occur.

5 SIGNAL GND terminal

Connection for the ground wire of a turntable to reduce unwanted noise that occurs when a turntable is connected.



6 LINE/PHONO switch

Set to **[LINE]** when connecting a line-level output device (multi player, etc.) to the **[CH3]** / **[CH4]** input terminals.

Set to **[PHONO]** when connecting a phono-level (MM cartridge) output device (turntable, etc.) to the **[CH3]** / **[CH4]** input terminals.



7 LINE/PHONO input terminals

Connection for a phono-level (MM cartridge) output device (turntable, etc.) or a line-level output device (multi player, etc.). You can switch the input source depending on the connected device using the **[LINE/PHONO]** switch on the unit's rear panel.

- Set the [ **A, PHONO/LINE,**  **B]** switch on the top of the unit to **[PHONO/LINE]** before connecting a device.

8 LINE input terminals

Connection for a line-level output device (multi player, etc.).

- Set the [ **A, LINE,**  **B]** switch on the top of the unit to **[LINE]** before connecting a device.

9 DMX output terminal

This is a DMX interface for rekordbox to enable lighting effects to be synchronized with music.

Lighting information set in Lighting mode in rekordbox can be sent as DMX signals from the unit to a DMX compatible lighting fixture. Also, when using Performance mode in rekordbox, you can synchronize lighting effects with the music played by a DJ.

10 USB port (USB B)

Connection for a PC/Mac.

- Be sure to use the USB cable specified below.
 - To connect to a USB Type-C port: use the USB cable supplied with the unit or a USB 2.0 compliant cable
 - To connect to a USB Type-A port: use a USB cable certified to the appropriate standard with a length of 3 m or less
- When using a USB hub, be sure it's a product recommended by the manufacturer of your PC/Mac.

11 USB port (USB A)

Connection for a PC/Mac.

- Be sure to use the USB cable specified below.
 - To connect to a USB Type-C port: use the USB cable supplied with the unit or a USB 2.0 compliant cable
 - To connect to a USB Type-A port: use a USB cable certified to the appropriate standard with a length of 3 m or less
- When using a USB hub, be sure it's a product recommended by the manufacturer of your PC/Mac.



12 MIC 2 input terminal

Connection for a microphone.

13 MIC 1 input terminal

Connection for a microphone.

14 switch

Turn the power to the unit on () or off ()

15 DC IN terminal

Connection for a power outlet using the supplied AC adapter (connected with the supplied power cord).

- Connect the AC adapter after all other connections are complete.
- Be sure to use the AC adapter supplied with the unit.

16 Cord hook

Hook for the AC adapter's power cord to reduce the risk of accidental disconnection.

- If the AC adapter is disconnected during playback, the sound will be interrupted.

Front panel

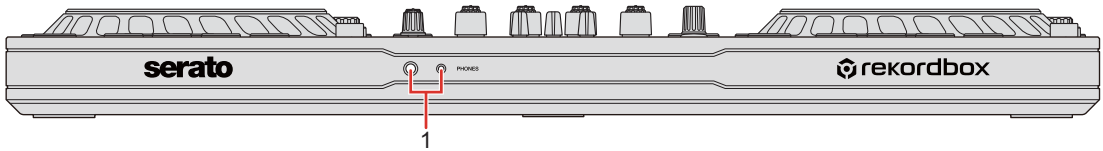

1 PHONES output terminals

Connection for your headphones.

1/4" stereo jack and 3.5-mm stereo mini jack can be used with the unit.

- Only use headphones with 32 Ω or more impedance. Headphones with impedance lower than 32 Ω won't work with the unit.

Connections

- Be sure to turn off the unit and disconnect the power cord from the outlet before connecting devices.
- Only connect the power cord to a power outlet after you've made all other connections.
- Be sure to use the supplied power cord and AC adapter.
- Refer to the instruction manuals for any devices you want to connect.
- To connect to your PC/Mac, use the supplied USB cable or one that supports USB 2.0.
- Be sure to use the USB cable specified below.
 - To connect to a USB Type-C port: use the USB cable supplied with the unit or a USB 2.0 compliant cable
 - To connect to a USB Type-A port: use a USB cable certified to the appropriate standard with a length of 3 m or less
- When using a USB hub, be sure it's a product recommended by the manufacturer of your PC/Mac.

Connection examples

Connecting input terminals

Rear panel

(1) Turntable, (2) Multi player, (3) Microphone, (4) PC/Mac, (5) Portable audio device, (6) AC adapter, (7) Power cord, (8) Connection to a power outlet

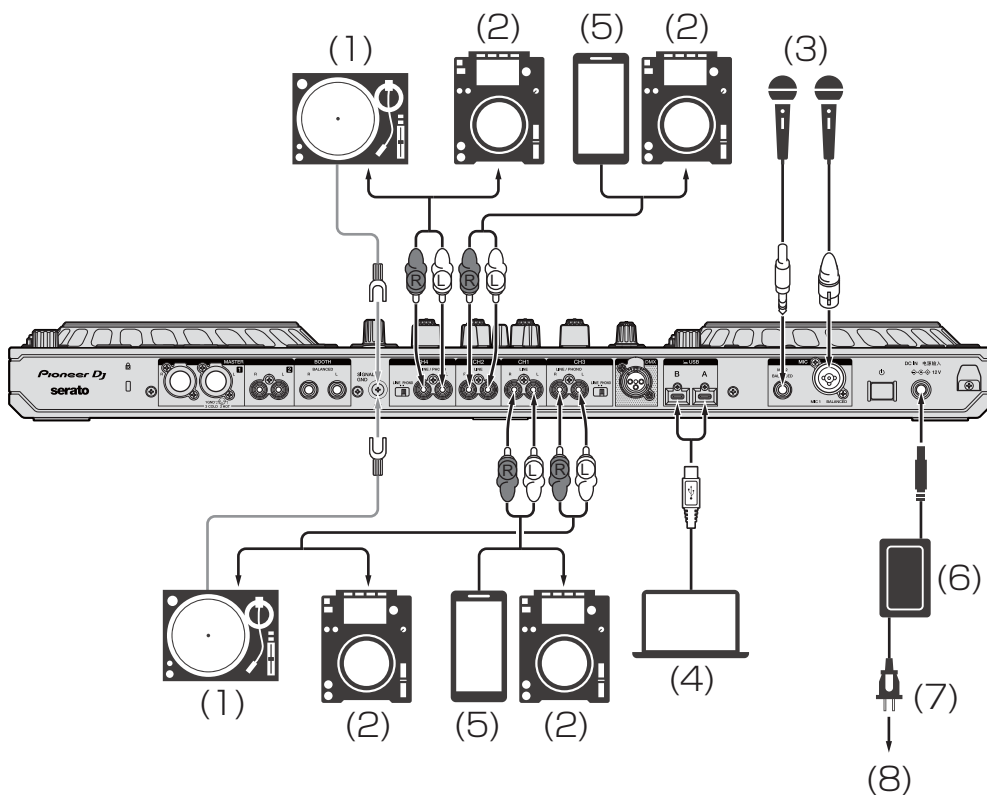

When connecting a turntable to the **[CH3]** / **[CH4]** input terminals, set the **[LINE/PHONO]** switch beside the terminals to **[PHONO]**.

When connecting a multi player to the **[CH3]** / **[CH4]** input terminals, set the **[LINE/PHONO]** switch beside the terminals to **[LINE]**.

Cord hook

Fasten the AC adapter's power cord in place by hooking it onto the cord hook.

This prevents the power cord from being accidentally pulled and the plug from being disconnected from the terminal.

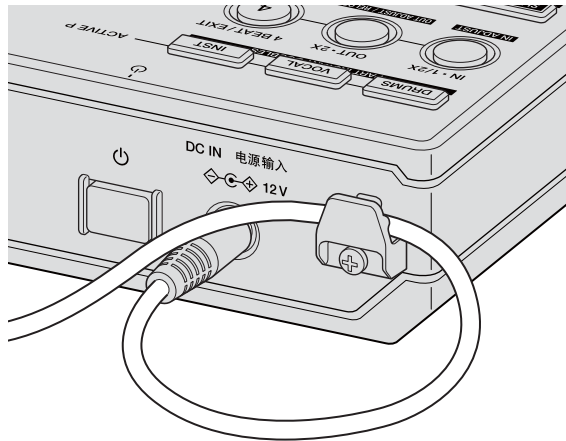

- Never bend the base of the AC adapter's power cord when fastening it. If used continuously under these conditions, the power cord may be damaged, resulting in faulty contact.

Connecting output terminals

Front panel

(1) Headphones

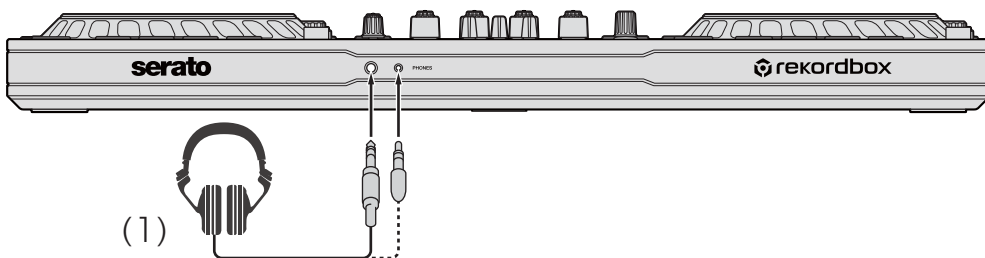

Rear panel

- (1) Powered amplifier, powered speakers, etc.,
- (2) Powered amplifier (for booth monitor), powered speakers, etc.,
- (3) Home stereo, powered amplifier, powered speakers, etc.,
- (4) DMX cable (XLR 3 pin), (5) Lighting fixture

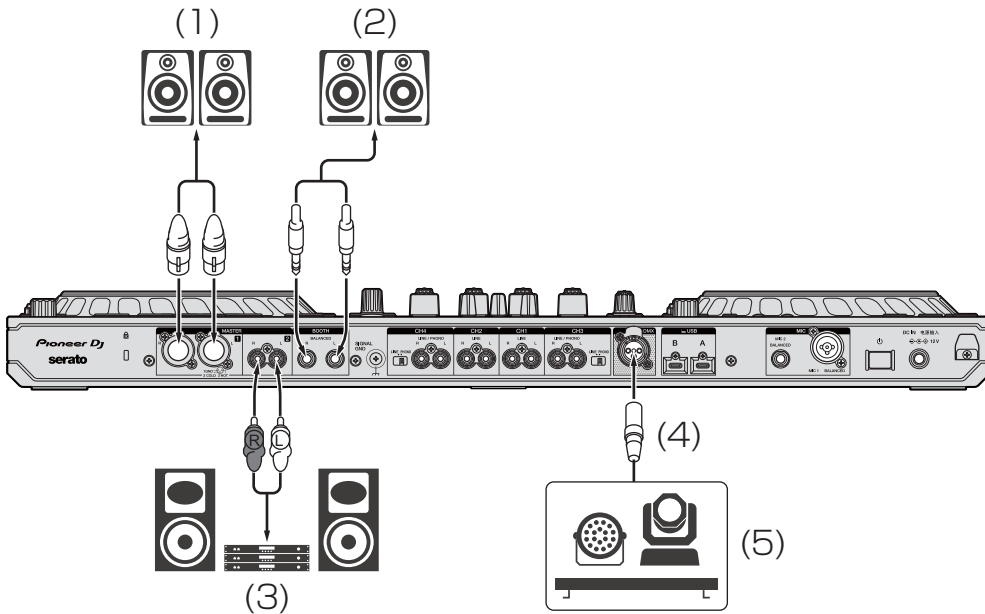

- Be sure to use the **[MASTER 1]** output terminals for a balanced output.
If these terminals are connected to an unbalanced input (such as RCA) using an XLR to RCA converter cable (or a converter adapter), etc., sound quality may decrease or unwanted noise may occur.
- To connect to an unbalanced input (such as RCA), use the **[MASTER 2]** output terminals.
- Be careful not to accidentally insert the power cord plug of another unit or device into one of the **[MASTER 1]** output terminals.
- Never connect devices capable of supplying phantom power to the **[MASTER 1]** output terminals.

- Be sure to use the **[BOOTH]** output terminals for a balanced output. If these terminals are connected to an unbalanced input (such as an RCA or TS terminal) using a TRS to RCA converter cable (or a converter adapter), TS cable, etc., sound quality may decrease or unwanted noise may occur.

Connecting

- 1 Connect your headphones to one of the **[PHONES]** output terminals on the unit's front panel.
- 2 Connect an output device such as a powered amplifier to the **[MASTER 1]** output terminals or **[MASTER 2]** output terminals.
 - To output the sound from the **[BOOTH]** output terminals, connect a device to use as a booth monitor.
 - To use an output device such as a multi player, connect to the **[CH3]** / **[CH4]** input terminals and set the **[LINE/PHONO]** switch.
- 3 Connect the unit to your PC/Mac via a USB cable.
- 4 Turn on your PC/Mac.
- 5 Connect the AC adapter.
- 6 Press the **[⏻]** switch on the unit's rear panel to turn it on.
 - For Windows users
The "preparing device" message may appear. In this case, wait until the "ready-to-use" message appears.
- 7 Turn on the devices connected to the **[MASTER 1]** output terminals and **[MASTER 2]** output terminals.
 - When a microphone, multi player, or other external device is connected to the input terminals, turn on that device too.

rekordbox

Installing rekordbox

Getting started with rekordbox

If you're using rekordbox for the first time, download the latest version from rekordbox.com and install it in the following way.

If you already have rekordbox installed, update to the latest version using the Update Manager which you'll see when you start rekordbox.

- You are responsible for preparing your PC/Mac, network devices, and other elements needed to connect to the internet.

Installing rekordbox

Procedures may differ depending on the operating system (OS) of your PC/Mac.

❖ Installing (Mac)

Do not connect the unit to your Mac until installation is complete.

- Close all programs on your Mac.
 - 1 Unzip the downloaded rekordbox software file.
 - 2 Double-click the unzipped software file to launch the installer.

- 3 Read the terms of the License Agreement carefully and if you agree to them, click **[Agree]**.

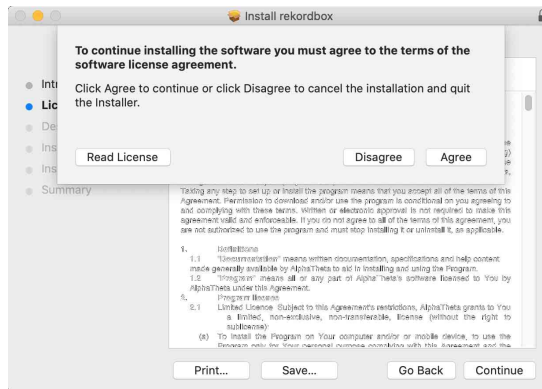

- If you do not agree to the contents of the License Agreement, click **[Disagree]** to cancel the installation.

- 4 When the screen for completing the installation appears, click **[Close]** to end the installation.

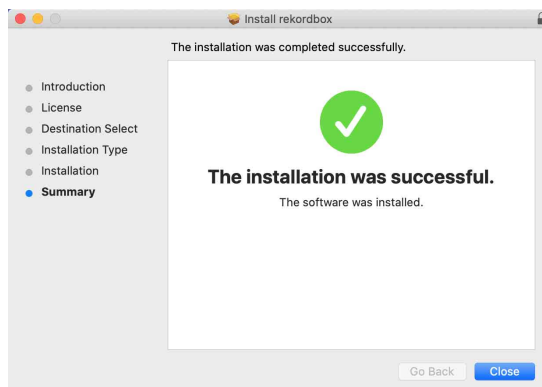

❖ Installing (Windows)

Do not connect the unit to your PC until installation is complete.

- Log into your PC as an administrator before starting the installation.
- Close all programs on your PC.

- 1 Unzip the downloaded rekordbox software file.
- 2 Double-click the unzipped software file to launch the installer.

- 3 Read the terms of the License Agreement carefully and if you agree to them, select **[Agree]**, then click **[Next]**.

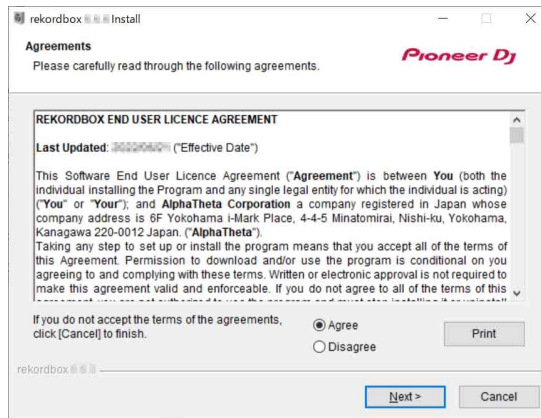

- If you do not agree to the contents of the license agreement, click **[Cancel]** to cancel the installation.
- After specifying the destination, the installation will start. When the installation is finished, a completion message will be displayed.

- 4 Click **[Finish]** to complete the installation.

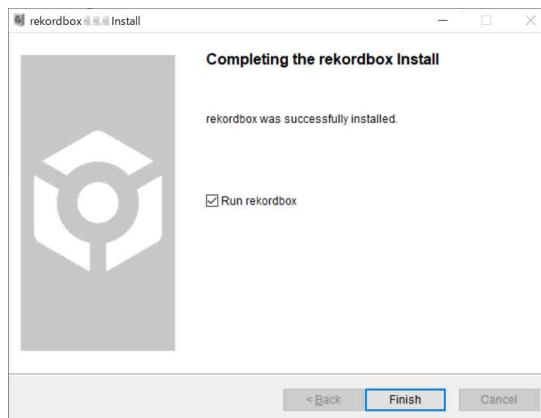

Installation is complete.

Basic use

Starting rekordbox

You need to register a Pioneer DJ account to use rekordbox.
For details, refer to the rekordbox Introduction.

For Mac

In Finder, open the **[Applications]** folder, then double-click the **[rekordbox 6] > [rekordbox.app]** icon.

For Windows 11

In the **[Start]** menu, open the **[All apps]** screen, then click the **[rekordbox 6]** icon under **[Pioneer]**.

For Windows 10

In the **[Start]** menu, click the **[rekordbox 6]** icon under **[Pioneer]**.

Checking audio setup

Check that the **[Audio]** settings in **[Preferences]** in rekordbox are set as follows:

For Mac

[Audio]: [DDJ-FLX10]

[Output channels]:

[Master Output]: [DDJ-FLX10 : MASTER + audio device name on Mac]

[Headphones Output]: [DDJ-FLX10 : PHONES]

- When PC MASTER OUT is off, **[Master Output]** in the **[Audio]** setting is **[DDJ-FLX10 : MASTER]**.

For Windows

[Audio]: [DDJ-FLX10 ASIO]

[Output channels]:

[Master Output]: [DDJ-FLX10 ASIO : MASTER + audio device name on PC]

[Headphones Output]: [DDJ-FLX10 ASIO : PHONES]

- When PC MASTER OUT is off, **[Master Output]** in the **[Audio]** setting is **[DDJ-FLX10 ASIO : MASTER]**.
- PC Master Out is a function that can output the master sound of rekordbox from the speaker(s) of the connected PC/Mac. By default, PC Master Out is set to on.
- To cancel outputting the master sound of rekordbox from the speaker(s) of the connected PC/Mac, click  in the top-right area of the rekordbox screen so its light switches off.

Adding music files into your Collection

The **[Collection]** screen contains a list of music files managed by rekordbox.

Add music files on your PC/Mac to your Collection so the software can analyze them and they can be used in rekordbox.

- 1 Click **[Collection]** on the tree view.
A list of tracks in your **[Collection]** is displayed.
- 2 Open Finder (Mac) or Explorer (Windows) and drag and drop music files, or folders containing music files, into the track list.
Music files are added into the **[Collection]** and analysis for the music files begins. Wait until analysis of all music files is complete.

Loading an audio track onto a deck

The following explains how to load a track onto deck 1 as an example.



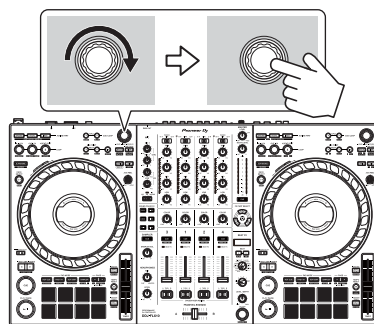

Turn the rotary selector to select a track in your **[Collection]** and press the rotary selector for deck 1.

The track loads onto deck 1.



Playing a track

This section explains how to play sound from deck 1 (left) as an example.

- Set the positions of the knobs, etc. as follows:
 - [ **A**, **LINE**,  **B**] switch: [ **A**]
 - [**TRIM**] knob: turned fully counterclockwise
 - EQ [**HI**/**MID**/**LOW**] knobs: center position (12 o'clock)
 - [**COLOR**] knob: center position
 - Channel fader: bottom position
 - [**MASTER LEVEL**] knob: turned fully counterclockwise
 - Crossfader: center position
 - Crossfader assign switch: [**THRU**]
- Press the [**PLAY/PAUSE**  / ] button to play the track.

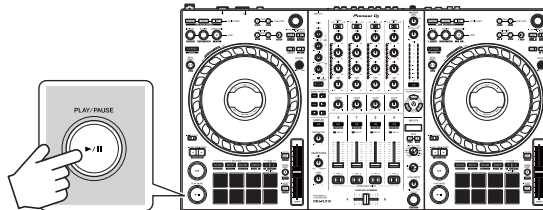

- Turn the [**TRIM**] knob.
Adjust the [**TRIM**] knob so the channel level indicator lights up orange at the loudest part of the track.

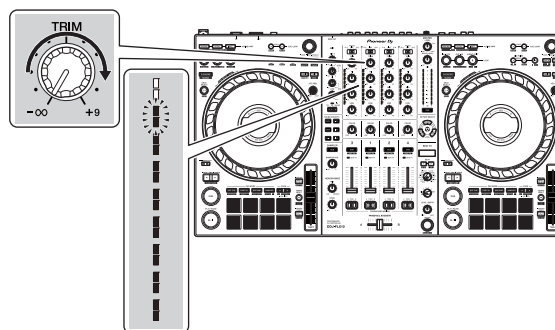

4 Move the channel fader to the top.

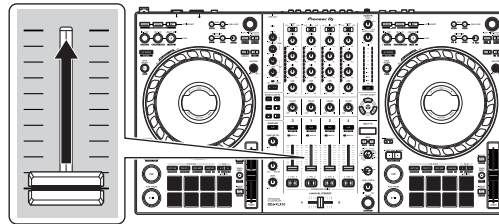

5 Turn the **[MASTER LEVEL]** knob to adjust the volume of the speakers to a level you're happy with.

Adjust the volume of sound output from the **[MASTER 1]** output terminals or **[MASTER 2]** output terminals.

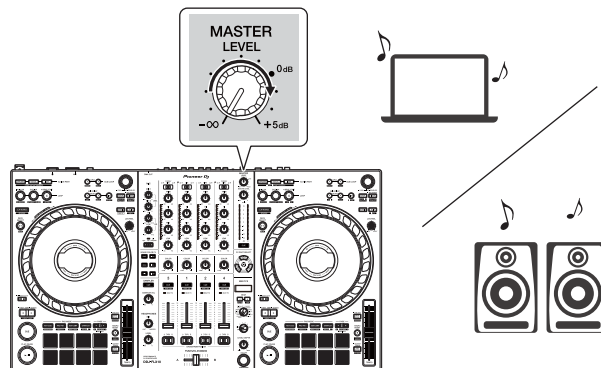

- If you're outputting sound from the speaker of your PC/Mac, adjust the speaker volume on the PC/Mac instead of using the **[MASTER LEVEL]** knob.
- If you can't output sound from the **[MASTER 1]** output terminals or **[MASTER 2]** output terminals or the unit isn't recognized by your PC/Mac, refer to the **[FAQ]** on the Pioneer DJ support website.

pioneerdj.com/support/

Monitoring with headphones

This section explains how to play sound from deck 1 (left) as an example.

- 1 Set the positions of knobs, etc. as shown below.
 - **[HEADPHONES MIX]** knob: Center
 - **[HEADPHONES LEVEL]** knob: Turned fully counterclockwise
- 2 Press the headphones **[CUE]** button for channel 1.
- 3 Turn the **[HEADPHONES LEVEL]** knob.
Adjust the headphones volume to a level you're happy with.

Quitting rekordbox

Click the **[x]** button or select **[Exit]** from the **[File]** menu.

Turning off the unit

Press the **[⏻]** switch on the unit's rear panel to turn the unit off.

Advanced use

Using 4 Beat Loop

While a track is playing, press the **[4 BEAT/EXIT]** button.

Loop playback starts with 4 beats from the point where you press the button.

- When the Quantize function is turned on, you might notice a slight delay as the loop synchronizes to the beat.

❖ Canceling loop playback

Press the **[4 BEAT/EXIT]** button.

When the loop out point is reached, the rest of the track continues to play without returning to the loop in point.

Using Manual Loop

You can use Manual Loop to choose the section you want to loop in a track.

- When the Quantize function is turned on, you might notice a slight delay as the loop synchronizes to the beat.
- 1 During playback, press the **[LOOP IN, 1/2X]** button at the point you want to start looping (the loop in point).
 - 2 Press the **[LOOP OUT, 2X]** button at the point you want the loop to end (the loop out point).
Loop playback starts.

❖ Cutting the loop

Press the **[LOOP IN, 1/2X]** button during loop playback.

Each time you press the button, the loop cuts in half.

- You can cut the loop length in half even during 4 Beat Loop playback.

❖ Extending the loop

Press the **[LOOP OUT, 2X]** button during loop playback.

Each time you press the button, the loop doubles in length.

- You can double the loop length even during 4 Beat Loop playback.

❖ Canceling a loop

Press the **[4 BEAT/EXIT]** button.

The rest of the track continues to play without returning to the loop in point.

❖ Changing the loop in point

Press the **[LOOP IN, 1/2X]** button while holding the **[SHIFT]** button and turn the jog wheel during loop playback.

The loop in point changes.

❖ Changing the loop out point

Press the **[LOOP OUT, 2X]** button while holding the **[SHIFT]** button and turn the jog wheel during loop playback.

The loop out point changes.

Using the Performance Pads

You can switch functions using the respective Pad mode buttons (the **[HOT CUE]** mode button, **[PAD FX1]** mode button, **[BEAT JUMP]** mode button, and **[SAMPLER]** mode button).

❖ Using Hot Cues

You can start playback instantly from the position where a Hot Cue is set. Loops can also be set and called up instantly.

- Up to 16 Hot Cues can be set and saved for each track in rekordbox.

Setting and calling up a Hot Cue

- 1 Press the **[HOT CUE]** mode button.

The unit enters Hot Cue mode.

- For 16 Hot Cues assigned to the Performance Pads, you can switch to Hot Cue A through H by pressing the **[PAGE ◀]** button, and Hot Cue I through P by pressing the **[PAGE ▶]** button. Also, the Hot Cue display on the deck screen in rekordbox will be switched.

- 2 When the track is playing or paused, press a Performance Pad to set a Hot Cue.

Hot Cues are set to Performance Pads as follows:

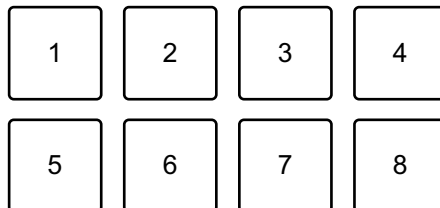

When you press the **[PAGE ◀]** button

- 1: Hot Cue A, 2: Hot Cue B, 3: Hot Cue C, 4: Hot Cue D,
5: Hot Cue E, 6: Hot Cue F, 7: Hot Cue G, 8: Hot Cue H

When you press the **[PAGE ►]** button

1: Hot Cue I, 2: Hot Cue J, 3: Hot Cue K, 4: Hot Cue L,
5: Hot Cue M, 6: Hot Cue N, 7: Hot Cue O, 8: Hot Cue P

3 Press a Performance Pad you've set a Hot Cue for.

Playback starts from the Hot Cue point.

- You can clear Hot Cues by pressing a Performance Pad while holding the **[SHIFT]** button.
- You can use Gate playback while the track is paused by setting the **[Preferences] > [Controller] > [Deck] > [HOT CUE] > [During Pause, GATE playback is applied.]** in rekordbox.

Setting and calling up 4 Beat Loop

1 Press the **[HOT CUE]** mode button.

The unit enters Hot Cue mode.

2 Press the **[4 BEAT/EXIT]** button during playback.

A loop with 4 beats is set at the position where you pressed the button, and loop playback starts.

3 Press a Performance Pad to set a loop during loop playback.

4 Press the Performance Pad.

Loop playback starts from the loop in point.

- You can clear the loop by pressing the Performance Pad while holding the **[SHIFT]** button.

Setting and calling up Manual Loop

1 Press the **[HOT CUE]** mode button.

The unit enters Hot Cue mode.

2 Press the **[LOOP IN, 1/2X]** button during playback, and press the **[LOOP OUT, 2X]** button.

Loop playback starts.

- 3 Press a Performance Pad to set a loop during the loop playback.
- 4 Press the Performance Pad.
Loop playback starts from the loop in point.
 - You can clear the loop by pressing the Performance Pad while holding the **[SHIFT]** button.

❖ Using Pad FX

You can add a wide range of effects to your performances simply by pressing and releasing the Performance Pads.

- 1 Press the **[PAD FX1]** mode button.

The unit enters Pad FX mode.

Effects are set to the Performance Pads as follows:

- For 16 effects assigned to the pads, you can switch to Effect A through H by pressing the **[PAGE ◀]** button, and Effect I through P by pressing the **[PAGE ▶]** button. Also, the Pad FX display on the deck screen in rekordbox will be switched.

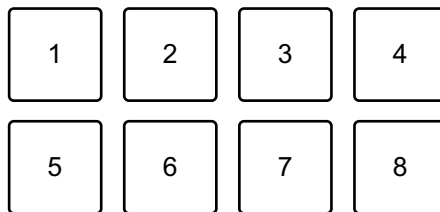

When you press the **[PAGE ◀]** button

1: Effect A, 2: Effect B, 3: Effect C, 4: Effect D,
5: Effect E, 6: Effect F, 7: Effect G, 8: Effect H

When you press the **[PAGE ▶]** button

1: Effect I, 2: Effect J, 3: Effect K, 4: Effect L,
5: Effect M, 6: Effect N, 7: Effect O, 8: Effect P

To use Pad FX mode 2, press the **[PAD FX1]** mode button while holding the **[SHIFT]** button.

Effects are set to the Performance Pads as follows:

- For 16 effects assigned to the pads, you can switch to Effect Q through X by pressing the **[PAGE ◀]** button, and Effect Y through AF by pressing the **[PAGE ▶]** button. Also, the Pad FX display on the deck screen in rekordbox will be switched.

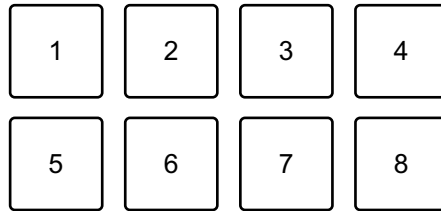

When you press the **[PAGE ◀]** button

1: Effect Q, 2: Effect R, 3: Effect S, 4: Effect T,
5: Effect U, 6: Effect V, 7: Effect W, 8: Effect X

When you press the **[PAGE ▶]** button

1: Effect Y, 2: Effect Z, 3: Effect AA, 4: Effect AB,
5: Effect AC, 6: Effect AD, 7: Effect AE, 8: Effect AF

2 Press and hold down a Performance Pad.

The effect turns on. The sound changes according to the type of effect and the number of beats in the settings assigned to that pad.

3 Release the Performance Pad.

The effect turns off.

Using Release FX of Pad FX

You need to assign a Release FX to a Performance Pad in advance.

1 Press and hold down a Performance Pad that has an effect other than a Release FX assigned to it.

The effect turns on. The sound changes according to the type of effect and the number of beats in the settings assigned to that pad.

- 2 Press the Performance Pad that has a Release FX assigned to it, and release it.

The effect turns off, and the Release FX is added.

❖ Using Beat Jump

You can move the playback position instantly, without breaking the rhythm of the track that's playing.

- 1 Press the **[BEAT JUMP]** mode button.

The unit enters Beat Jump mode.

The number of beats set to the Performance Pads are as follows (Default):

- To change the number of beats or bars, press the **[PAGE ◀]** button or **[PAGE ▶]** button.

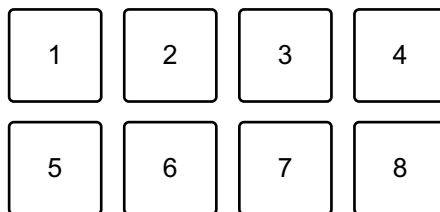

1: 1 beat (left direction), 2: 1 beat (right direction), 3: 2 beats (left direction), 4: 2 beats (right direction), 5: 4 beats (left direction), 6: 4 beats (right direction), 7: 8 beats (left direction), 8: 8 beats (right direction)

- 2 Press a Performance Pad.

- Pad 1, 3, 5 or 7: The playback position is moved to the left by the number of beats set on the pad.
- Pad 2, 4, 6 or 8: The playback position is moved to the right by the number of beats set on the pad.

❖ Using Sampler

You can use the Performance Pads to play tracks or sounds assigned to the Sampler slots.

Preparing to use Sampler

Click the  button at the top-left of the rekordbox screen to display the **[SAMPLER]** panel.

Loading a track into a Sampler slot

- 1 Press the **[SAMPLER]** mode button.
The unit enters Sampler mode.
- 2 Press the **[PAGE ◀]** button or **[PAGE ▶]** button.
The Sampler bank changes.
- 3 Press the rotary selector to move the cursor to the track list.
- 4 Turn the rotary selector.
Select a track you want to load into a Sampler slot.
- 5 Press a Performance Pad while holding the **[SHIFT]** button.
The selected track is loaded into the Sampler slot.
 - Loading a sound into a slot that already has a sound loaded may not be possible depending on the **[Preferences]** settings in rekordbox. You may need to clear the slot before loading the new sound.

Playing Sampler sounds with Performance Pads

- 1 Press the **[SAMPLER]** mode button.
The unit enters Sampler mode.
- 2 Press the **[PAGE ◀]** button or **[PAGE ▶]** button.
The Sampler bank changes.
- 3 Turn the  **[GAIN]** on the **[SAMPLER]** panel to adjust the Sampler volume.
- 4 Press a Performance Pad.
The track or sound assigned to the relevant slot is played.

- Sampler slots are set to Performance Pads as follows. (The slots in brackets are for when the Pad mode of deck 2 or deck 4 is set to Sampler mode.)

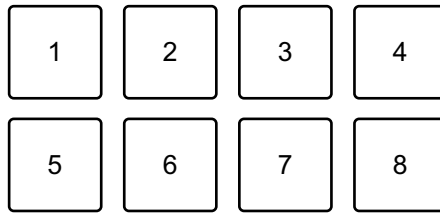

1: Slot 1 (slot 9), 2: Slot 2 (slot 10), 3: Slot 3 (slot 11), 4: Slot 4 (slot 12),
5: Slot 5 (slot 13), 6: Slot 6 (slot 14), 7: Slot 7 (slot 15), 8: Slot 8 (slot 16)

- 5 During Sampler playback, press the Performance Pad again.
The sound plays from the beginning again.
- 6 Press a Performance Pad while holding the **[SHIFT]** button during Sampler playback.
The sound of the slot that is currently playing stops.

❖ Using Keyboard mode

Use Performance Pads to play a Hot Cue in different pitches, as if you're using a keyboard.

- 1 Press the **[HOT CUE]** mode button while holding the **[SHIFT]** button.
The unit enters Keyboard mode.
- 2 Press a Performance Pad.
Select the Hot Cue you want to use with Keyboard mode.
 - If no Hot Cue is set, the current playback position is set as a Hot Cue. After selecting the Hot Cue which you set, the Hot Cue is used with Keyboard mode.
 - To reselect a Hot Cue, press the **[HOT CUE]** mode button while holding the **[SHIFT]** button.

When the Hot Cue is selected, the various pitches are set to the Performance Pads as follows (Default):

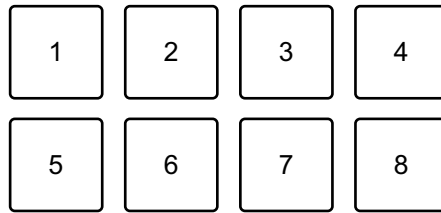

1: +4 Semitones, 2: +5 Semitones, 3: +6 Semitones, 4: +7 Semitones,

5: 0 Semitones, 6: +1 Semitone, 7: +2 Semitones, 8: +3 Semitones

A semitone is a unit used to determine the pitch of a sound. +1 semitone means the sound is higher in pitch than the original sound by half.

- 3 Press the **[PAGE ◀]** button or **[PAGE ▶]** button to change the pitch set to the Performance Pad.
- 4 Press a Performance Pad.
Playback starts from the Hot Cue point, with the sound pitch assigned to that pad.

❖ Using Beat Loop

If you press a Performance Pad, a loop with the number of beats assigned to the pad is set. The loop keeps playing after you remove your finger from the pad.

- 1 Press the **[BEAT JUMP]** mode button while holding the **[SHIFT]** button.
The unit enters Beat Loop mode.
The number of beats set to the Performance Pads are as follows (Default):
 - Press the **[PAGE ◀]** button or **[PAGE ▶]** button to change the number of beats set to the Performance Pad.

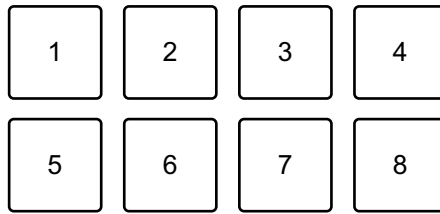

1: Beat Loop 1/64 beat, 2: Beat Loop 1/32 beat, 3: Beat Loop 1/16 beat,
 4: Beat Loop 1/8 beats, 5: Beat Loop 1/4 beats, 6: Beat Loop 1/2 beats,
 7: Beat Loop 1 beats, 8: Beat Loop 2 beats

2 Press a Performance Pad.

The loop plays with the number of beats set on that pad.

3 Press the same Performance Pad again.

The loop is canceled and the rest of the track continues to play.

❖ Using Key Shift

When you press a Performance Pad in Key Shift mode, the key of the track that's currently playing is changed to the pitch set to the pressed pad.

1 Press the **[SAMPLER]** mode button while holding the **[SHIFT]** button.

The unit enters Key Shift mode.

The various pitches are set to the Performance Pads as follows (Default):

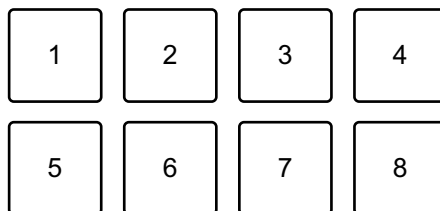

1: +4 Semitones, 2: +5 Semitones, 3: +6 Semitones, 4: +7 Semitones,

5: 0 Semitones, 6: +1 Semitone, 7: +2 Semitones, 8: +3 Semitones

A semitone is a unit used to determine the pitch of a sound. +1 semitone means the sound is higher in pitch than the original sound by half.

- 2 Press the **[PAGE ◀]** button or **[PAGE ▶]** button to change the pitch set to the Performance Pad.
- 3 Press a Performance Pad.
The track's key is changed to the pitch assigned to the pad.
- 4 Press the **[KEY SYNC]** button while holding the **[SHIFT]** button.
The track's key returns to the original key.

Setting and calling up a cue point or loop point

❖ Setting a cue point or loop point

- 1 Pause the track and move the playback position to where you want to set a cue point or loop point.
- 2 Press the **[CUE]** button while the track is paused.
- 3 Press the **[CUE/LOOP CALL ◀]** button while holding the **[SHIFT]** button.
The cue point or loop point is saved.

❖ Calling up the cue point or loop point

Press the **[CUE/LOOP CALL ▶]** button or **[CUE/LOOP CALL ◀]** button.

The cue point or loop point is called up.

❖ Deleting the cue point or loop point

- 1 Press the **[CUE/LOOP CALL ▶]** button or **[CUE/LOOP CALL ◀]** button.
The cue point or loop point is called up.

- 2 Press the **[CUE/LOOP CALL ►]** button while holding the **[SHIFT]** button.
The cue point or loop point is deleted.

Using Slip

If you turn Slip mode on, normal playback continues in the background while you scratch, play a loop, or play a Hot Cue. When you stop scratching or playing the loop or Hot Cue, normal playback resumes from the position reached in the background.

- The **[SLIP]** button lights up when Slip mode is on, and flashes during playback in the background.

❖ Slip Scratch Play

- 1 Make sure Vinyl mode is turned on.
Check that the **[SLIP]** button lights up while holding the **[SHIFT]** button.
 - For the default setting, Vinyl mode is on.
- 2 Press the **[SLIP]** button.
The unit enters Slip mode.
- 3 To scratch the track, turn the top of the jog wheel during playback.
Normal playback continues in the background while you're scratching.
- 4 Release the top of the jog wheel.
Playback starts from the position reached in the background.
 - To cancel Slip mode, press the **[SLIP]** button again.

❖ Slip Hot Cue

- 1 Press the **[HOT CUE]** mode button.
The unit enters Hot Cue mode.
- 2 Press the Performance Pad to set the Hot Cue.

- 3 Press the **[SLIP]** button.
The unit enters Slip mode.
- 4 Press and hold a Performance Pad during playback.
Playback starts from the Hot Cue point. While holding the pad, playback continues.
Normal playback continues in the background during Hot Cue playback.
- 5 Release the Performance Pad.
Playback starts from the position reached in the background.
 - To cancel Slip mode, press the **[SLIP]** button again.

❖ Slip Braking

- 1 Adjust the **[Vinyl Speed Adjust] - [Touch/Brake]** setting in the **[Preferences] > [Controller] > [Deck]** tab in rekordbox.
With the **[Vinyl Speed Adjust]** setting, you can adjust the speed at which a track slows down until it stops.
When using Slip Braking, adjust **[Touch/Brake]** of **[Vinyl Speed Adjust]** to stop slowly.
- 2 Press the **[SLIP]** button.
The unit enters Slip mode.
- 3 Press the **[PLAY/PAUSE ►/III]** button during playback.
Playback slows down gradually and stops. Normal playback continues in the background.
- 4 Press the **[PLAY/PAUSE ►/III]** button again.
Playback starts from the position reached in the background.
 - To cancel Slip mode, press the **[SLIP]** button again.

❖ Slip Auto Beat Loop

- 1 Press the **[SLIP]** button.
The unit enters Slip mode.

- 2 Press the **[4 BEAT/EXIT]** button.
A 4-beat loop is set, and loop playback starts.
Normal playback continues in the background during loop playback.
- 3 Press the **[4 BEAT/EXIT]** button again.
The loop is canceled and playback starts from the position reached in the background.
 - To cancel Slip mode, press the **[SLIP]** button again.

❖ Slip Manual Loop

- 1 Press the **[SLIP]** button.
The unit enters Slip mode.
- 2 Press the **[LOOP IN, 1/2X]** button, then press the **[LOOP OUT, 2X]** button.
Loop playback starts.
Normal playback continues in the background during loop playback.
- 3 Press the **[4 BEAT/EXIT]** button.
The loop is canceled and playback resumes from the position reached in the background.
 - To cancel Slip mode, press the **[SLIP]** button again.

Using Fader Start

❖ Using Channel Fader Start

- 1 Set the cue point.
Pause the track at the position you want to start playback from, then press the **[CUE]** button on that deck.

- 2 While holding the **[SHIFT]** button, move the channel fader from the bottom to the top.

Playback starts from the cue point.

- If you move the channel fader back to the bottom while holding the **[SHIFT]** button during playback, the track instantly jumps back to the cue point and playback pauses. (Back Cue)

When no cue point is set, playback starts from the beginning of the track.

❖ Using Crossfader Start

When you want to use the Crossfader Start function, set the crossfader assign switch of the channel to **[A]** or **[B]**.

- 1 Set the cue point.

Pause the track at the position you want to start playback from, then press the **[CUE]** button on that deck.

- 2 Move the crossfader all the way to the left or right side.

If you want to use Crossfader Start to trigger playback on channel 2, set the crossfader to the left side, and vice versa.

- 3 While holding the **[SHIFT]** button, move the crossfader towards the opposite side from where it's set.

Playback starts from the cue point.

- If you move the crossfader back while holding the **[SHIFT]** button during playback, the playback position instantly jumps back to the cue point and pauses. (Back Cue)

When no cue point is set, playback starts from the beginning of the track.

Analyzing tracks

Track analysis starts when you drag and drop a music file, or a folder containing music files, into the Track List in rekordbox.

- If a track is loaded to a deck before analysis is complete, it may take some time to display its BPM and waveform.

- Depending on the number of tracks, analysis may take some time.

Using Beat FX

You can apply effects that match the tempo (BPM) of the track loaded on the deck.

Effects section display



- 1 Effect name
Displays the name of the selected effect.
- 2 AUTO / TAP
When the BPM measurement mode is set to Auto mode, **[AUTO]** is displayed.
When it's set to Manual Input mode, **[TAP]** is displayed.
- 3 BPM value
Displays the automatically detected BPM in Auto mode.
If the BPM can't be detected, the previously detected BPM value flashes.
Displays the manually input BPM in Manual Input mode.
- 4 Selected channel
Displays the channel to which the effect will be applied. Displays **[SP]** (Sampler), **[MIC]**, **[CH 1]**, **[CH 2]**, **[CH 3]**, **[CH 4]**, or **[MST]** (Master) according to the selected channel.
- 5 Parameter
Displays parameters of the selected effect.

❖ Using Beat FX

- 1 Press the **[BEAT ◀]** button or **[BEAT ▶]** button while holding the **[SHIFT]** button.
 Selects the BPM measurement mode.
 - **[AUTO]**: Press the **[BEAT ◀]** button while holding the **[SHIFT]** button. The BPM is automatically measured from the input audio signal.
 - **[TAP]**: Press the **[BEAT ▶]** button while holding the **[SHIFT]** button. You can now enter the BPM manually by tapping the **[TAP]** button.

- 2 Turn the **[BEAT FX]** select knob.
 Selects a type of effect.
 The first effect type on the FX1 unit in rekordbox will be changed.

- 3 Turn the **BEAT FX CH** select knob.
 Selects a channel to apply the effect to.
 - **[SP]**: Applies the effect to the sampler sound.
 - **[MIC]**: Applies the effect to the microphone sound.
 - **[1]** to **[4]**: Applies the effect to the sound of the respective channel.
 - **[MST]**: Applies the effect to the sound of the master channel.
 - For microphone sound and external input sound, the effect from the unit will be applied.

👉 Read: Beat FX types on the unit (page 94)

- 4 Press the **[BEAT ◀]** button or **[BEAT ▶]** button.
 Sets the number of beats synchronized to the effect sound.
 The effect time corresponding to the number of beats is set automatically.

- 5 Press the **[BEAT FX ON/OFF]** button.
 The effect is applied to the sound.
 You can adjust the effect's parameter by turning the **[BEAT FX LEVEL/DEPTH]** knob.
 The **[BEAT FX ON/OFF]** button flashes when the effect is on.
 - Press the **[BEAT FX ON/OFF]** button again to turn the effect off.

❖ Beat FX types on the unit

Beat FX	Explanation
LOW CUT ECHO	<p>Outputs the delay sound with the low frequency cut several times while attenuating it according to the number of beats.</p> <ul style="list-style-type: none"> • ◀ / ▶: Sets the delay time (number of beats) from 1/16 to 16 beats. • LEVEL/DEPTH: Sets the balance between the original sound and the echo sound.
ECHO	<p>Outputs the delay sound several times while attenuating it according to the number of beats.</p> <ul style="list-style-type: none"> • ◀ / ▶: Sets the delay time (number of beats) from 1/16 to 16 beats. • LEVEL/DEPTH: Sets the balance between the original sound and the echo sound.
MULTI TAP DELAY	<p>Outputs the delay sound up to 7 times in 1/8 beat units according to the number of beats.</p> <ul style="list-style-type: none"> • ◀ / ▶: Sets the effect time (number of beats) from 1/16 to 16 beats. • LEVEL/DEPTH: Sets the balance between the original sound and the effect sound.

Beat FX	Explanation
SPIRAL	<p>Adds a reverb effect to the input sound. When the delay time is changed, the pitch will also change at the same time.</p> <ul style="list-style-type: none"> • ◀ / ▶: Sets the delay time (number of beats) from 1/16 to 16 beats. • LEVEL/DEPTH: Sets the balance and feedback between the original sound and the effect sound.
REVERB	<p>Adds a reverb effect to the input sound.</p> <ul style="list-style-type: none"> • ◀ / ▶: Sets the reverb effect size (1 to 100%). • LEVEL/DEPTH: Sets the balance between the original sound and the effect sound.
TRANS	<p>Cuts the sound periodically according to the number of beats.</p> <ul style="list-style-type: none"> • ◀ / ▶: Sets the cycle (number of beats) to cut from 1/16 to 16 beats. • LEVEL/DEPTH: Sets the balance between the original sound and the effect sound and the length of time to cut the sound.
ENIGMA JET	<p>Creates a flanger effect in which the pitch continues to rise or fall according to the number of beats.</p> <ul style="list-style-type: none"> • ◀ / ▶: Sets the effect rate (number of beats). When you set from +1/16 to +64 beats, the pitch raises. When you set from -64 to -1/16 beats, the pitch lowers. • LEVEL/DEPTH: Sets how the effect applies.

Beat FX	Explanation
FLANGER	<p>Creates a one-cycle flanger effect according to the number of beats.</p> <ul style="list-style-type: none"> • ◀ / ▶: Sets the effect rate (number of beats) from 1/16 to 64 beats per beat of BPM. • LEVEL/DEPTH: Sets how the effect applies.
PHASER	<p>Changes the Phaser effect according to the number of beats.</p> <ul style="list-style-type: none"> • ◀ / ▶: Sets the effect rate (number of beats) from 1/16 to 64 beats. • LEVEL/DEPTH: Sets how the effect applies.
STRETCH	<p>Records the input sound when the effect is turned on, and outputs the recorded sound stretched to the set number of beats.</p> <ul style="list-style-type: none"> • ◀ / ▶: Sets the retrigger cycle (number of beats) from 1/16 to 16 beats. The input sound is recorded again according to the retrigger cycle. • LEVEL/DEPTH: Sets the number of beats of time-stretch.
SLIP ROLL	<p>Records the input sound when the effect is turned on, and outputs the recorded sound repeatedly according to the set number of beats. When the effect time changes, the input sound is recorded again.</p> <ul style="list-style-type: none"> • ◀ / ▶: Sets the effect time (number of beats) from 1/16 to 16 beats. • LEVEL/DEPTH: Sets the balance between the original sound and the effect sound.

Beat FX	Explanation
ROLL	<p>Records the input sound when the effect is turned on, and outputs the recorded sound repeatedly according to the set number of beats.</p> <ul style="list-style-type: none"> • ◀ / ▶: Sets the effect time (number of beats) from 1/16 to 16 beats. • LEVEL/DEPTH: Sets the balance between the original sound and the effect sound.
MOBIUS \mathbb{N} (SAW)	<p>Creates a saw wave that sounds as if the pitch continues to rise or fall according to the number of beats.</p> <p>The sound mixed with the input sound outputs. The saw wave can output without input sound.</p> <ul style="list-style-type: none"> • ◀ / ▶: Sets the effect rate (number of beats). When setting between +1/16 and +64 beats, the pitch raises. When setting between -64 and -1/16 beats, the pitch lowers. • LEVEL/DEPTH: Sets the volume of the saw wave to be mixed.

Beat FX	Explanation
MOBIUS \wedge (TRI)	<p>Creates a triangle wave that sounds as if the pitch continues to rise or fall according to the number of beats.</p> <p>The sound mixed with the input sound outputs. The triangle wave can output without input sound.</p> <ul style="list-style-type: none">• \blacktriangleleft / \blacktriangleright: Sets the effect rate (number of beats). When setting between +1/16 and +64 beats, the pitch raises. When setting between -64 and -1/16 beats, the pitch lowers.• LEVEL/DEPTH: Sets the volume of the triangle wave to be mixed.

Using Sound Color FX

You can apply effects that change as you turn the **[COLOR]** knob for each channel.

- For channels with external input sound, the unit's effects are applied.
 ➔ Read: Sound Color FX types on the unit (page 99)

1 Press one of the **[SOUND COLOR FX]** buttons.

Selects an effect type.

The pressed button flashes.

- If you already selected one button and then pressed another, the newly pressed button is selected.
- The same effect is set for all channels.

2 Turn a **[COLOR]** knob.

The effect is applied to that channel.

❖ Canceling Sound Color FX

Press the flashing **[SOUND COLOR FX]** button.

The effect is canceled.

❖ Sound Color FX types on the unit

Effect	Explanation
SPACE	Gives a reverb effect. <ul style="list-style-type: none"> • COLOR: Turn counterclockwise: Applies the reverb effect to the mid-range and low-range. Turn clockwise: Applies the reverb effect to the mid-range and high-range.

Effect	Explanation
DUB ECHO	<p>Outputs delayed sound repeatedly while attenuating it and gives an echo effect.</p> <ul style="list-style-type: none"> • COLOR: <ul style="list-style-type: none"> Turn counterclockwise: Applies the echo effect to the mid-range. Turn clockwise: Applies the echo effect to the high-range.
CRUSH	<p>Changes the output sound so it sounds like it's "crushing".</p> <ul style="list-style-type: none"> • COLOR: <ul style="list-style-type: none"> Turn counterclockwise: Applies "crushed" effect to the sound. Turn clockwise: Crushes sound, then applies the high-pass filter effect.
PITCH	<p>Changes the pitch.</p> <ul style="list-style-type: none"> • COLOR: <ul style="list-style-type: none"> Turn counterclockwise: The pitch falls. Turn clockwise: The pitch rises.
NOISE	<p>Outputs white noise generated inside the unit mixed into the sound of the channel via the filter.</p> <ul style="list-style-type: none"> • COLOR: <ul style="list-style-type: none"> Turn counterclockwise: Gradually decreases the cut-off frequency of the filter through which the white noise passes. Turn clockwise: Gradually increases the cut-off frequency of the filter through which the white noise passes.

Effect	Explanation
FILTER	<p>Outputs sound that has passed through a filter.</p> <ul style="list-style-type: none"> • COLOR: Turn counterclockwise: Gradually decreases the low-pass filter's cut-off frequency. Turn clockwise: Gradually increases the high-pass filter's cut-off frequency.

Using FX Part Select

The effect applies to the selected part (Drums / Vocal / INST) of the loaded track.

- The effect applies to all parts when using sound from the external inputs, microphone, or sampler.

1 Select a part, or multiple parts, with the **[FX PART SELECT]** buttons.

Press **[DRUMS]**, **[VOCAL]**, or **[INST]** button and the button will light up. The effect applies to all parts with lit buttons.

2 Apply an effect.

When the sound is applied with Beat FX, Sound Color FX, or Pad FX, the effect applies to the selected part only.

➡ Read: Using Beat FX (page 92)

➡ Read: Using Sound Color FX (page 99)

➡ Read: Using Pad FX (page 80)

To cancel FX Part Select

When all **[FX PART SELECT]** (**[VOCAL]**, **[DRUMS]**, **[INST]**) buttons light up, the effect applies to all parts, which means FX Part Select is canceled.

Using Mix Point Link

You can use this function to mix to your next track easily by setting the start and end points on the track for On Air.

This section explains how to mix track A which is On Air on deck 1 with track B on deck 2 as an example.

- 1 Press the **[PAGE ◀]** button or **[PAGE ▶]** button while holding the **[SHIFT]** button to change the On Jog Display to Waveform mode.
 - Set a cue point or Hot Cue point where you want to set the mix point on the track in advance.
- 2 Load track B onto deck 2 to be played after track A.
 - On the On Jog Display of deck 2, the upper enlarged waveform is for track B, and the lower enlarged waveform is for track A.
- 3 Press the **[CUE/LOOP CALL ◀]** button or **[CUE/LOOP CALL ▶]** button, or the Performance Pad set with the Hot Cue point on deck 2 to call up the cue point or Hot Cue point where you want to set the mix point to start for mixing on track B.
 - ➡ Read: Setting and calling up a cue point or loop point (page 87)
 - ➡ Read: Using Hot Cues (page 78)
 - ➡ Read: Monitoring with headphones (page 75)
- 4 Press the **[MIX POINT SELECT ◀]** button or **[MIX POINT SELECT ▶]** button on deck 2 to select a mix point to end for mixing on currently playing track A.
 - On the On Jog Display, the mix point on track B appears on the upper enlarged waveform, and the mix point on track A appears on the lower enlarged waveform.
 - On the On Jog Display, the Mix Point Link status indicator appears on green as activated.
 - In step 4, the operation of the cue point or Hot Cue point is for selecting mix points, and sound on deck 2 can't be monitored. To monitor the sound on deck 2, go to step 3.

5 Press the **[MIX POINT LINK]** button of deck 2.

The Mix Point Link settings are complete.



The point on track A and the point on track B are linked, and auto playback is set on track B (Mix Point Link).

Track B automatically starts playing from the beginning of the track at the specified mix point.

- To mute sound from the beginning of track B to a specific point, call up the point when the Mix Point Link status indicator appears, and press the **[MIX POINT LINK]** button while holding the **[SHIFT]** button. Track B will start playing from the beginning, but the sound will be muted until you reach the point where you pressed the **[MIX POINT LINK]** button (Silent). When you press the **[MIX POINT LINK]** button while holding the **[SHIFT]** button again, Silent will be canceled.
- After setting Mix Point Link, if the playback position of deck 1 jumps before reaching the mix point (e.g. if you call up a Hot Cue, scratch the track, etc.), the mix point link is canceled, but you can relink at the set mix point by pressing the **[MIX POINT LINK]** button again while the **[MIX POINT LINK]** button flashes.
- After setting Mix Point Link, press the **[MIX POINT LINK]** button again or press the **[MIX POINT SELECT ◀]** button while holding the **[SHIFT]** button to cancel the setting for Mix Point Link.

Recording

rekordbox has a recording feature that you can use to capture your performances. For detailed instructions on recording, see the rekordbox Instruction Manual.

- 1 Click the  button at the top-left of the rekordbox screen to display the **[REC]** panel.
- 2 Click  on the **[REC]** panel in rekordbox to start recording.
 - If you click  again, recording stops.
 - When recording is complete, the file is automatically saved.

- You can change the saving destination of files in the **[Preferences]** > **[Controller]** > **[Recordings]** tab in rekordbox.

Using a microphone

- 1 Connect a microphone to the **[MIC 1]** input terminal or **[MIC 2]** input terminal.
- 2 Set the **[MIC OFF, ON, TALKOVER]** switch to **[ON]** or **[TALKOVER]**.
 - **[ON]**: The indicator lights up.
 - **[TALKOVER]**: The indicator flashes.
 - When you set the switch to **[TALKOVER]**, the sound of channels other than the **[MIC1]** channel and **[MIC2]** channel is attenuated by -18 dB (default) when a sound of -10 dB or greater is input to the microphone.
 - The level of attenuation applied when you set the switch to **[TALKOVER]** can be changed in **[Preferences]** in rekordbox. For details on how to change this setting, read: **[Microphone Input]** > **[Talkover Level]** setting (page 110)
 - You can switch Talkover mode between Normal mode and Advanced mode. For details on how to change this setting, read: **[Microphone Input]** > **[Talkover Mode]** setting (page 109)
- 3 Turn the **[MIC 1 LEVEL]** knob or **[MIC 2 LEVEL]** knob.
Adjust the volume of the sound output from the **[MIC 1]** input terminal or **[MIC 2]** input terminal.
 - The sound comes out at a high volume if the knob is turned all the way to the right.
- 4 Speak into the microphone.
 - Sound input from the **[MIC 1]** input terminal or **[MIC 2]** input terminal can't be output from the speaker(s) of your PC/Mac even if PC Master Out is turned on.

❖ Adjusting the sound

Turn the **[MIC EQ (HI, LOW)]** knobs.

- **[HI]**: -12 dB to +12 dB (10 kHz)
- **[LOW]**: -12 dB to +12 dB (100 Hz)

❖ Using MIC FX

- 1 Click the  button at the top-left of the rekordbox screen.
The MIC panel is displayed.



- 2 Adjust the **[FX]** knob in rekordbox.
- 3 Click the **[REVERB]** button in rekordbox.
REVERB applies to the microphone sound.
MIC FX in rekordbox can only be set to Reverb.

Using external inputs

The unit has four sets of external inputs to connect multi players, turntables, etc. The “4-channel mixer” of the unit can be used to mix input sound without it passing through your PC/Mac. You can use the following mixer features even when not connected to a PC/Mac.

- For details on the respective items, read: Connecting (page 66) and Part names and functions (page 10)

❖ Mixing the sound of a multi player, etc.

- 1 Connect a multi player or other line-level output device to the **[LINE]** input terminal or the **[LINE/PHONO]** input terminal.

- 2 Set the **[LINE/PHONO]** switch on the unit's rear panel to **[LINE]**.
- 3 Set the [**A, LINE**, **B**] switch or [**A, PHONO/LINE**, **B**] switch on the unit's top panel to **[LINE]** or **[PHONO/LINE]**.
- 4 Turn the **[TRIM]** knob and move the channel fader to adjust the volume of the sound output from each channel.

❖ **Mixing the sound of turntables, etc.**

- 1 Connect turntables or other phono-level (MM cartridge) output devices to the **[LINE/PHONO]** input terminals of **[CH3]** or **[CH4]**.
 - **[CH1]** and **[CH2]** are input terminals for line-level devices only.
 - Be sure to connect the ground wire of the turntable to the **[SIGNAL GND]** terminal of the unit.
- 2 Set the **[LINE/PHONO]** switch on the unit's rear panel to **[PHONO]**.
- 3 Set the [**A, PHONO/LINE**, **B**] switch on the unit's top panel to **[PHONO/LINE]**.
- 4 Turn the **[TRIM]** knob and move the channel fader to adjust the volume of the sound output from each channel.

Changing the settings in rekordbox

You can change the settings of the unit in rekordbox under **[Controller]** in **[Preferences]**.

When you connect the unit to rekordbox, you can change the following settings:

[Controller] > **[Deck]** tab:

[Ring Brightness] setting

Set the brightness of the jog ring illumination.

[OFF] turns off the illumination, and you can set it from **[1]** to **[3]**.

- Set to **[1]** for the darkest illumination, and **[3]** for the brightest illumination.

[Ring Color] setting

Set the lighting color of the jog ring illumination.

- **[ACTIVE PART Linked to Jog Color 1]**

The lighting color of the jog ring illumination is linked to the setting of the active part.

When two parts are selected, the illumination lights with the mixed color of the two parts. When all parts are selected, the illumination lights in white.

- **[ACTIVE PART Linked to Jog Color 2]**

The lighting color of the jog ring illumination is linked to the setting of the active part.

When more than one part is selected, the illumination lights in white.

- **[Customize]**

The illumination lights in the specified color regardless of the active part settings.

[Display Brightness] setting

Set the brightness of the On Jog Display.

You can set it from **[1]** to **[5]**.

- Set to **[1]** for the darkest display, and **[5]** for the brightest display.

[Time Mode] setting

Set time information displayed on the On Jog Display.

- **[Elapsed]**: Displays the time of the current playback position with the beginning of the track as 0:00.
- **[Remaining]**: Displays the remaining time from the current playback position with the end of the track as 0:00.

[Slip Mode Flashing] setting

Set Slip Mode Flashing.

- **[Enable]**: When Slip mode is on, the buttons that can work in Slip mode will flash.
- **[Disable]**: When Slip mode is on, the buttons that can work in Slip mode won't flash.

[Slip button LED while Slip mode is on] setting

Set the lighting operation of the **[SLIP]** button when Slip mode is on.

- **[Light is On]**: When Slip mode is on, the **[SLIP]** button lights, and the button flashes during slip operation.
- **[Blink]**: When Slip mode is on, the **[SLIP]** button always flashes.

[Controller] > **[Mixer]** tab:**[CROSSFADER Curve]** setting

Set the crossfader curve.

- When turning counterclockwise, the curve slowly rises.
- When turning clockwise, the curve quickly rises.

[Fader Start] setting

Change the setting of the Fader Start function.

Select **[Activate the fader start when moving a channel fader or the crossfader while pressing the SHIFT button.]** to turn the setting on.

[CROSSFADER] > [Cut Lag] setting

Adjust the Cut Lag on both edges of the crossfader.

Units of 0.1 mm can be adjusted from 0.3 mm to 5.5 mm.

- The default Cut Lag amount is 1.0 mm.
- This Cut Lag setting is a guide, and may not be exact.

[Booth Output] setting

Change whether or not the microphone sound comes out of the booth channel.

If you don't select **[Don't output microphone sound to the Booth output.]**, the microphone sound comes out of the booth channel. If you select the setting, microphone sound doesn't come out of the booth channel.

[Microphone Input] > [Talkover Mode] setting

Change Talkover mode.

- **[Advanced]**: Only the mid-range sound, other than the microphone channel, is attenuated according to the set value of the Talkover level.

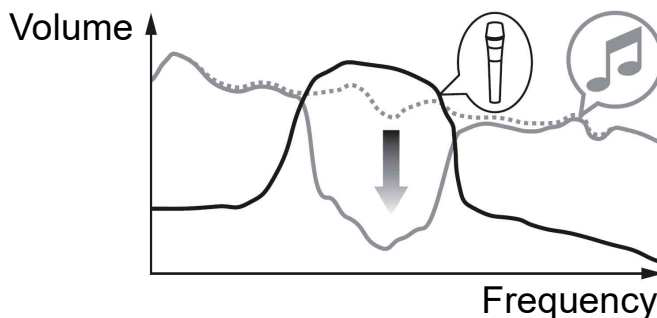

- **[Normal]**: Sound, other than the microphone channel, is attenuated according to the set value of the Talkover level.

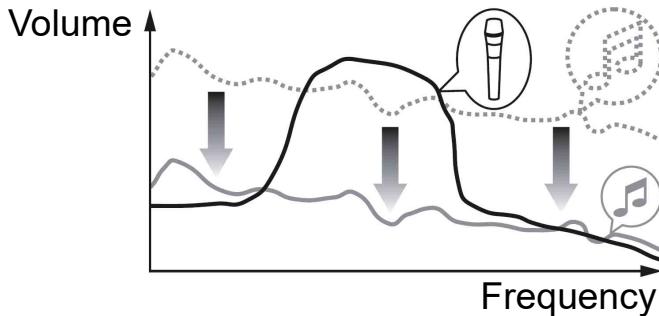

[Microphone Input] > [Talkover Level] setting

Set the audio attenuation level of Talkover mode.

Setting values: **[-6 dB]** / **[-12 dB]** / **[-18 dB]** / **[-24 dB]**

[Headphones] setting

Change the output sound from the **[PHONES]** output terminals.

- **[STEREO]**: Outputs the monitor sound in stereo.
- **[MONO SPLIT]**: Outputs the monitor sound other than the master sound from the left channel and the monitor sound of the master sound from the right channel.

If you select **[Invert LR audio of the headphones]** when setting **[MONO SPLIT]**, sound of the left and right channel will be swapped.

[Display Brightness] setting

Set the brightness of the effects section display.

You can set it from **[1]** to **[3]**.

- Set to **[1]** for the darkest display, and **[3]** for the brightest display.

[Controller] > [DDJ-FLX10] setting

[Master Output] > [Attenuator Level] setting

Set the master output attenuator level.

Setting values: **[0 dB] / [-6 dB] / [-12 dB]**

[Master Output] > [Monaural/Stereo Selection] setting

Change whether mono or stereo sound is output from the master output.

- **[Monaural]**: Outputs in mono.
- **[Stereo]**: Outputs in stereo.

[Booth Output] > [Attenuator Level] setting

Set the booth output attenuator level.

Setting values: **[0 dB] / [-6 dB] / [-12 dB]**

[Booth Output] > [Monaural/Stereo Selection] setting

Change whether mono or stereo sound is output from the **[BOOTH]** output terminals.

- **[Monaural]**: Outputs booth sound in mono.
- **[Stereo]**: Outputs booth sound in stereo.

[Peak Limiter] > [Master/Booth Output] setting

Prevent sudden and unpleasant digital clipping of audio output from the **[MASTER 1]**, **[MASTER 2]**, and **[BOOTH]** output terminals.

- **[Enable]**: Enable the peak limiter.
- **[Disable]**: Disable the peak limiter.

[Peak Limiter] > [Microphone Output (Master)] setting

Prevent sudden and unpleasant digital clipping of microphone sound added to the master output.

- **[Enable]**: Enable the peak limiter.
- **[Disable]**: Disable the peak limiter.

[Peak Limiter] > [Microphone Output (Booth)] setting

Prevent sudden and unpleasant digital clipping of microphone sound added to the booth output.

- **[Enable]**: Enable the peak limiter.
- **[Disable]**: Disable the peak limiter.

[REC OUT] setting

Set whether to output microphone sound to the REC output.

If you set **[Mix the MIC audio to REC OUT]**, the microphone sound can be output to the REC output.

[Demo / Screen saver] setting

Set the Screen Saver and the time to pass before Demo mode starts. The default setting is **[Demo (10 minutes)]**.

To cancel Demo mode or Screen Saver, operate any knob or button on the unit.

- **[Demo (1 minute)]**: Demo mode starts when there is no operation on the unit for 1 minute.
- **[Demo (5 minutes)]**: Demo mode starts when there is no operation on the unit for 5 minutes.
- **[Demo (10 minutes)]**: Demo mode starts when there is no operation on the unit for 10 minutes.
- **[Screen Saver]**: Screen Saver starts when there is no operation on the unit for 30 minutes.
- **[Disable]**: Demo mode and Screen Saver feature never start.

[Auto Standby] setting

Change the Auto Standby setting.

When this setting is enabled, the unit enters Standby mode automatically after 4 hours if the following conditions are met.

- None of the unit's buttons or knobs are operated.
- No audio signal of -24 dB or greater is input to an input terminal of the unit.
- Press the **[QUANTIZE]** button on the left deck to cancel Standby mode.

Serato DJ Pro

Installing Serato DJ Pro

❖ Installing (Mac)

Do not connect the unit to your Mac until installation is complete.

- Close all programs on your Mac.
- 1 Unzip the downloaded Serato DJ Pro software file.
 - 2 Double-click the unzipped software file to launch the installer.
 - 3 Read the terms of the License Agreement carefully and if you agree, click **[Agree]**.

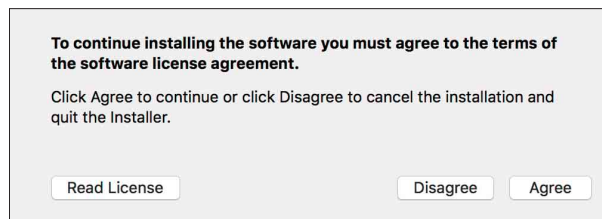

- If you don't agree to the contents of the License Agreement, click **[Disagree]** to cancel the installation.
- 4 Click **[Install]**.
 - 5 Follow the on-screen instructions to install the software.

6 Click **[Close]** to quit the installer.

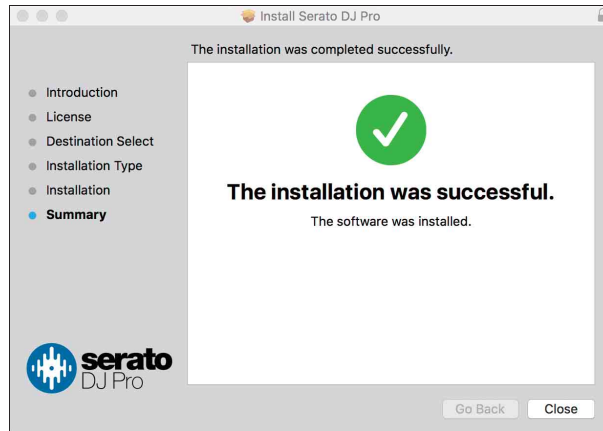

❖ Installing (Windows)

Do not connect the unit to your PC until installation is complete.

- Log into your PC as an administrator before starting the installation.
- Close all programs on your PC.

- 1 Unzip the downloaded Serato DJ Pro software file.
- 2 Double-click the unzipped software file to launch the installer.
- 3 Read the terms of the License Agreement carefully and if you agree, select **[I agree to the license terms and conditions]**, then click **[Install]**.
 - If you don't agree to the contents of the License Agreement, click **[Close]** to cancel the installation.



A message indicating successful installation appears when installation is complete.

- 4 Click **[Close]** to quit the Serato DJ Pro installer.

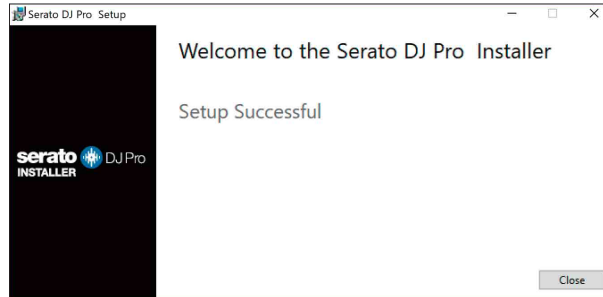

The following screen shows when tracks are loaded onto decks in Serato DJ Pro:

Click **[Library]** in the top-left corner of the screen, then select **[Vertical]** or **[Horizontal]** from the pull-down menu to change the screen layout.

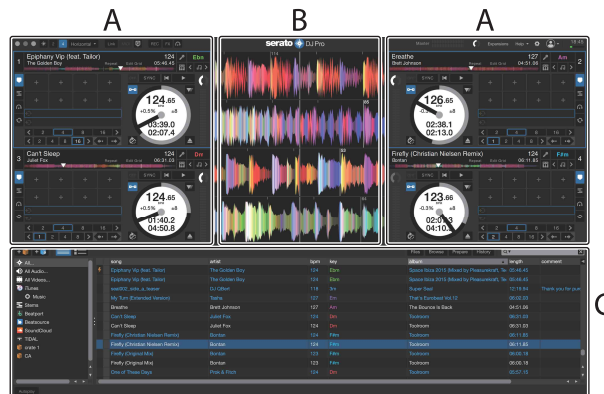

A Deck section

Track information (track name, artist name, BPM, etc.), the overall waveform, and other information about the loaded track is displayed.

B Waveform display

The waveform of the loaded track is displayed.

C Browse section

Tracks in the library, or crates containing multiple tracks, are displayed.

Importing music files (tracks)

- There are various ways to import tracks into Serato DJ Pro. For details, see the Serato DJ Pro software manual.
- If you've previously used Serato Limited's DJ software (e.g. Scratch Live, ITCH, or Serato DJ Intro) and you've already created track libraries, you can use these libraries with Serato DJ Pro.
- If you've previously used Serato DJ Intro and you've already created track libraries, you may need to reanalyze tracks to use them with Serato DJ Pro.

The typical way to import music files (tracks) is as follows:

- 1 Click the **[Files]** button in the Serato DJ Pro screen to open the **[Files]** panel.
The contents of your PC/Mac or the hard drive/device connected to the PC/Mac are displayed in the **[Files]** panel.
- 2 Click the folder containing the tracks you want to add to your library.
- 3 Drag and drop the selected folder to the crates panel.
A crate is created and the tracks are added to your library.





A **[Files]** panel

B Crates panel

Playing a track

This section explains how to play sound from deck 1 (left) as an example.

1 Set the positions of the knobs etc. as shown below.

- [ **A**, **LINE**,  **B**] switch: [ **A**]
- [**TRIM**] knob: turned fully counterclockwise
- EQ [**HI**/**MID**/**LOW**] knobs: center position (12 o'clock)
- [**COLOR**] knob: center position
- Channel fader: bottom position
- [**MASTER LEVEL**] knob: turned fully counterclockwise
- Crossfader: center position
- Crossfader assign switch: [**THRU**]

2 Press the [**PLAY/PAUSE**  / ] button to play the track.

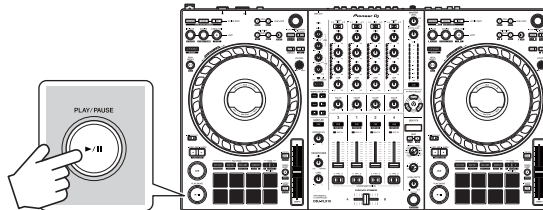

3 Turn the [**TRIM**] knob.

Adjust the [**TRIM**] knob so the channel level indicator lights up orange at the loudest part of the track.

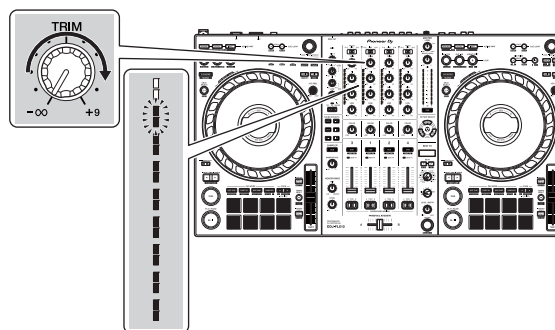

4 Move the channel fader to the top.

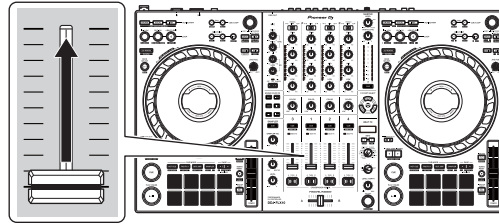

5 Turn the **[MASTER LEVEL]** knob to adjust the volume of the speakers to a level you're happy with.

Adjust the volume of sound output from the **[MASTER 1]** output terminals or **[MASTER 2]** output terminals.

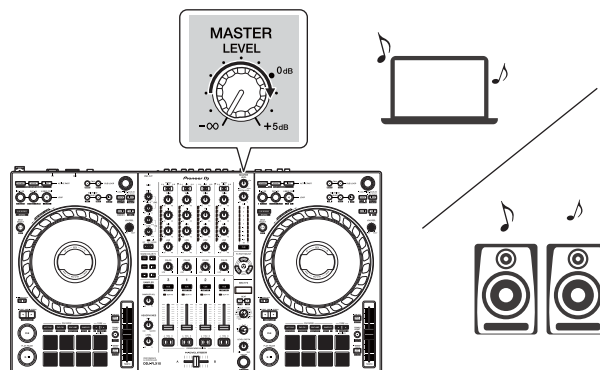

- If you can't output sound from the **[MASTER 1]** output terminals or **[MASTER 2]** output terminals or the unit isn't recognized by your PC/Mac, refer to the **[FAQ]** on the Pioneer DJ support website.

pioneerdj.com/support/

Monitoring with headphones

This section explains how to play sound from deck 1 (left) as an example.

- 1 Set the positions of knobs etc. as shown below.
 - **[HEADPHONES MIX]** knob: Center
 - **[HEADPHONES LEVEL]** knob: Turned fully counterclockwise
- 2 Press the headphones **[CUE]** button for channel 1.
- 3 Turn the **[HEADPHONES LEVEL]** knob.
Adjust the headphones volume to a level you're happy with.

Quitting Serato DJ Pro

Click the **[x]** button.

Turning off the unit

Press the **[⏻]** switch on the unit's rear panel to turn the unit off.

Advanced use

Using 4 Beat Loop

While a track is playing, press the **[4 BEAT/EXIT]** button.

Loop playback starts with 4 beats from the point where you press the button.

❖ Canceling loop playback

Press the **[4 BEAT/EXIT]** button.

When the loop out point is reached, the rest of the track continues to play without returning to the loop in point.

Using Manual Loop

You can use Manual Loop to choose the section you want to loop in a track.

- 1 During playback, press the **[LOOP IN, 1/2X]** button at the point you want to start looping (the loop in point).
- 2 Press the **[LOOP OUT, 2X]** button at the point you want the loop to end (the loop out point).
Loop playback starts.

❖ Cutting the loop

Press the **[LOOP IN, 1/2X]** button during loop playback.

Each time you press the button, the loop cuts in half.

- You can cut the loop length in half even during 4 Beat Loop playback.

❖ Extending the loop

Press the **[LOOP OUT, 2X]** button during loop playback.

Each time you press the button, the loop doubles in length.

- You can double the loop length even during 4 Beat Loop playback.

❖ Canceling a loop

Press the **[4 BEAT/EXIT]** button.

The rest of the track continues to play without returning to the loop in point.

❖ Changing the loop in point

Press the **[LOOP IN, 1/2X]** button while holding the **[SHIFT]** button and turn the jog wheel during loop playback.

The loop in point changes.

❖ Changing the loop out point

Press the **[LOOP OUT, 2X]** button while holding the **[SHIFT]** button and turn the jog wheel during loop playback.

The loop out point changes.

Using the Performance Pads

You can switch functions using the respective Pad mode buttons (the **[HOT CUE]** mode button, **[PAD FX1]** mode button, **[BEAT JUMP]** mode button, and **[SAMPLER]** mode button).

❖ Using Hot Cues

You can start playback instantly from the position where a Hot Cue is set.

- Up to 8 Hot Cues can be set and saved for each track in Serato DJ Pro.

1 Press the **[HOT CUE]** mode button.

The unit enters Hot Cue mode.

2 When the track is playing or paused, press a Performance Pad to set a Hot Cue.

The pad's settings are as shown below.

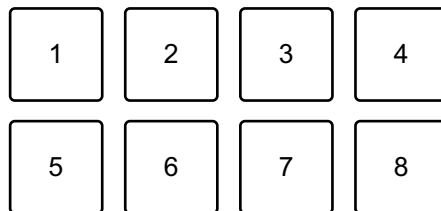

1: Hot Cue 1, 2: Hot Cue 2, 3: Hot Cue 3, 4: Hot Cue 4,
5: Hot Cue 5, 6: Hot Cue 6, 7: Hot Cue 7, 8: Hot Cue 8

3 Press a Performance Pad you've set a Hot Cue for.

Playback starts from the Hot Cue point.

- You can clear Hot Cues by pressing a Performance Pad while holding the **[SHIFT]** button.

❖ Using Pad FX

You can add a wide range of effects to your performances simply by pressing and releasing the Performance Pads.

- 1 Press the **[PAD FX1]** mode button.
The unit enters Pad FX mode.
- 2 Press and hold down a Performance Pad.
The effect set on the Performance Pad turns on.
The pad's settings are as shown below.

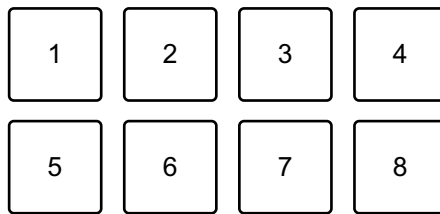

1: Effect A, 2: Effect B, 3: Effect C, 4: Effect D,
5: Effect E, 6: Effect F, 7: Effect G, 8: Effect H

- 3 Release the Performance Pad.
The effect turns off.

❖ Using Beat Jump

You can use Beat Jump to move the playback position by different numbers of beats.

- 1 Press the **[BEAT JUMP]** mode button.
The unit enters Beat Jump mode.
- 2 Press a Performance Pad when the track is playing or paused.
The pad's settings are as shown below.

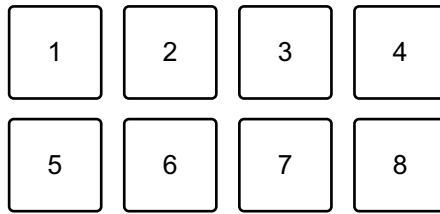

- 1: Beat Jump to the left, 2: Halve the Beat Jump length,
3: Double the Beat Jump length, 4: Beat Jump to the right,
5: Previous track, 6: Search ◀◀, 7: Search ▶▶, 8: Censor

❖ Using Sampler

You can use the Performance Pads to play tracks or sounds assigned to the Sampler slots.

- 1 Open the **[SAMPLER]** panel in Serato DJ Pro.
- 2 Press the **[SAMPLER]** mode button on the unit.
The unit enters Sampler mode.
- 3 Press the **[PAGE ◀]** button or **[PAGE ▶]** button.
The Sampler bank changes.
The sampler has 4 banks, A, B, C, and D, and each bank has 8 slots.
- 4 Drag and drop tracks or sounds from the library to load them into the **[SAMPLER]** panel's slots.
The track is loaded into the Sampler slot.
- 5 Press a Performance Pad.
The track or sound assigned to the relevant slot is played.
 - The playback method differs depending on the Sampler mode in Serato DJ Pro. For details, see the Serato DJ Pro software manual.

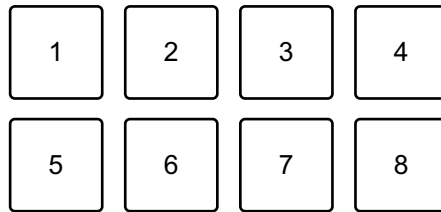

1: Slot 1, 2: Slot 2, 3: Slot 3, 4: Slot 4,
5: Slot 5, 6: Slot 6, 7: Slot 7, 8: Slot 8

- When you press a Performance Pad while holding the **[SHIFT]** button, the sound of the slot that is currently playing stops.

❖ Using Pitch Play

Pitch Play is a function of the Pitch 'n Time DJ expansion pack.

- 1 Press the **[HOT CUE]** mode button while holding the **[SHIFT]** button.

The unit enters Pitch Play mode.

- 2 Press a Performance Pad while holding the **[SHIFT]** button.
The Hot Cue point set on the Performance Pad is selected.

- 3 Press a Performance Pad.

Playback starts from the selected Hot Cue point with the pitch set to the Performance Pad as follows.

- To change the pitch range, press the **[PAGE ◀]** button or **[PAGE ▶]** button during Pitch Play. The pitch range changes between Up range, Middle range, and Down range each time you press the button.

Up range:

1	2	3	4
5	6	7	8

1: +4, 2: +5, 3: +6, 4: +7, 5: 0, 6: +1, 7: +2, 8: +3

Middle range:

1	2	3	4
5	6	7	8

1: 0, 2: +1, 3: +2, 4: +3, 5: -4, 6: -3, 7: -2, 8: -1

Down range:

1	2	3	4
5	6	7	8

1: -3, 2: -2, 3: -1, 4: 0, 5: -7, 6: -6, 7: -5, 8: -4

You can shift the pitch range in semitone steps by pressing the **[PAGE ◀]** button or **[PAGE ▶]** while holding the **[SHIFT]** button.

❖ Using Roll

If you press a Performance Pad when the unit is in Roll mode, a loop with the number of beats assigned to the pad is set and the loop plays until you release the pad.

During Loop Roll playback, normal playback with the original rhythm continues in the background (but you can only hear the Loop Roll). When you cancel Loop Roll, playback resumes from the position reached in the background.

1 Press the **[PAD FX1]** mode button while holding the **[SHIFT]** button. The unit enters Roll mode.

2 Press and hold down a Performance Pad.

Loop Roll playback starts with the number of beats in the settings assigned to that pad.

Playback continues in the background during Loop Roll playback (but you can only hear the Loop Roll).

- Press the **[PAGE ◀]** or **[PAGE ▶]** button during Loop Roll to change the number of beats for the Loop Roll that's currently playing.

For example, when you set the pads to 1/8 – 16 beats, the pad's settings are as shown below.

1	2	3	4
5	6	7	8

1: 1/8 beat, 2: 1/4 beat, 3: 1/2 beat, 4: 1 beat,

5: 2 beats, 6: 4 beats, 7: 8 beats, 8: 16 beats

The range of beats set for Loop Roll is shown on the Serato DJ Pro screen.

3 Release the Performance Pad.

Loop Roll is canceled, and playback resumes from the position reached in the background.

❖ Using Auto Loop

When you press a Performance Pad in Auto Loop mode, a loop with the number of beats assigned to the pad is set and the loop plays until you release the pad.

- 1 Press the **[BEAT JUMP]** mode button while holding the **[SHIFT]** button.

The unit enters Auto Loop mode.

- 2 Press a Performance Pad during playback.

Loop playback starts with the number of beats in the setting assigned to that pad.

- Each time you press the **[PAGE ◀]** button, the loop length is cut in half.
- Each time you press the **[PAGE ▶]** button, the loop length is doubled.
- When you press the **[PAGE ◀]** button or **[PAGE ▶]** button while holding the **[SHIFT]** button, the playback position moves by the length of the loop (Loop Shift).
- When you press the same Performance Pad again, loop playback is canceled.

The pad's settings are as shown below.

1	2	3	4
5	6	7	8

1: 1/8 beat, 2: 1/4 beat, 3: 1/2 beat, 4: 1 beat,
5: 2 beats, 6: 4 beats, 7: 8 beats, 8: 16 beats

❖ Using Key Shift

Key Shift is a function of the Pitch 'n Time DJ expansion pack.

- 1 Press the **[SAMPLER]** mode button while holding the **[SHIFT]** button.

The unit enters Key Shift mode.

- 2 Press a Performance Pad.

The track's key is changed to the pitch assigned to the pad.

- To change the key range, press the **[PAGE ◀]** button or **[PAGE ▶]** button during Key Shift. The key range changes between Up range, Middle range, and Down range each time you press the button.

Up range:

1	2	3	4
5	6	7	8

1: +4, 2: +5, 3: +6, 4: +7, 5: 0, 6: +1, 7: +2, 8: +3

Middle range:

1	2	3	4
5	6	7	8

1: 0, 2: +1, 3: +2, 4: +3, 5: -4, 6: -3, 7: -2, 8: -1

Down range:

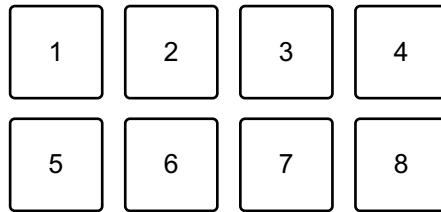

1: -3, 2: -2, 3: -1, 4: 0, 5: -7, 6: -6, 7: -5, 8: -4

Using Saved Flip

Serato Flip is a function that enables you to record a sequence, or call up a recorded sequence, of Hot Cues. The recorded sequence of Hot Cues is called a Flip.

You can save and play a Flip using Performance Pads on the unit.

- To use Saved Flip mode, you need to buy or subscribe to the Serato Expansion Packs, then activate them. For details, visit the URL below.

serato.com

❖ Saving a Flip to a slot

- 1 Create a Flip using Serato DJ Pro.
 - For details on how to create a Flip, refer to the Serato DJ Pro software manual (page 5).
- 2 Press and hold down the **[HOT CUE]** mode button.
The unit enters Saved Flip mode.
- 3 Press the Performance Pad for the slot you want to save the Flip to.
The Flip is saved to the slot.
 - Slots are assigned to Performance Pads as follows:

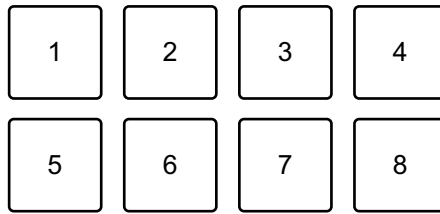

1: Slot 1, 2: Slot 2, 3: Slot 3, 4: Slot 4, 5: Slot 5, 6: Slot 6, 7: no slot, 8: no slot

- You can't save a Flip to a slot if all slots have saved Flips already. Delete a Flip on the slot screen in Serato DJ Pro to free up a slot for a new Flip.

❖ Calling up and playing a Flip

- 1 Press and hold down the **[HOT CUE]** mode button.
The unit enters Saved Flip mode.
- 2 Press the Performance Pad assigned with the slot (Flip) you want to play.

The Flip is called up and playback starts from the beginning of the Flip.

- Slots are assigned to Performance Pads as follows:

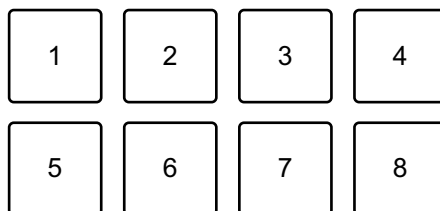

1: Slot 1, 2: Slot 2, 3: Slot 3, 4: Slot 4, 5: Slot 5, 6: Slot 6, 7: no slot, 8: no slot

- If you call up a Flip by pressing a Performance Pad while holding the **[SHIFT]** button, playback doesn't start from the beginning. Instead, Flip playback starts when the playback of the track reaches the beginning of the Flip.
- Press a Performance Pad during Flip playback to move to the beginning of the Flip that's playing.

Canceling Flip playback

Press the Performance Pad while holding the **[SHIFT]** button to cancel Flip playback and return to normal playback.

Using Slip

If you turn Slip mode on, normal playback continues in the background while you're scratching or playing a loop or Hot Cue. When you stop scratching or playing the loop or Hot Cue, normal playback resumes from the position reached in the background.

- The **[SLIP]** button lights up when Slip mode is on, and flashes during playback in the background.

❖ Slip Scratch Play

- 1 Make sure Vinyl mode is turned on.
Check that the **[SLIP]** button lights up while holding the **[SHIFT]** button.
 - For the default setting, Vinyl mode is on.
- 2 Press the **[SLIP]** button.
The unit enters Slip mode.
- 3 To scratch the track, turn the top of the jog wheel during playback.
Normal playback continues in the background while you're scratching.
- 4 Release the top of the jog wheel.
Playback starts from the position reached in the background.
 - To cancel Slip mode, press the **[SLIP]** button again.

❖ Slip Hot Cue

- 1 Press the **[HOT CUE]** mode button.
The unit enters Hot Cue mode.
- 2 Press a Performance Pad to set a Hot Cue.
- 3 Press the **[SLIP]** button.
The unit enters Slip mode.
- 4 Press and hold a Performance Pad during playback.
Playback starts from the Hot Cue point. While holding the pad, playback continues.
Normal playback continues in the background during Hot Cue playback.
- 5 Release the Performance Pad.
Playback starts from the position reached in the background.
 - To cancel Slip mode, press the **[SLIP]** button again.

❖ Slip Braking

- 1 Adjust the **[BRAKING]** - **[Stop Time]** setting in the **[DJ Preferences]** tab of the **[**] menu in Serato DJ Pro.
With the **[BRAKING]** setting, you can adjust the speed at which a track slows down until it stops.
When using Slip Braking, adjust the **[Stop Time]** knob of **[BRAKING]** to stop slowly.
- 2 Press the **[SLIP]** button.
The unit enters Slip mode.
- 3 Press the **[PLAY/PAUSE ►/III]** button during playback.
Playback slows down gradually and stops. Normal playback continues in the background.

- 4 Press the **[PLAY/PAUSE ►/III]** button again.
Playback starts from the position reached in the background.
 - To cancel Slip mode, press the **[SLIP]** button again.

❖ Slip Auto Beat Loop

- 1 Press the **[SLIP]** button.
The unit enters Slip mode.
- 2 Press the **[4 BEAT/EXIT]** button.
A 4-beat loop is set, and loop playback starts.
Normal playback continues in the background during loop playback.
- 3 Press the **[4 BEAT/EXIT]** button again.
The loop is canceled and playback starts from the position reached in the background.
 - To cancel Slip mode, press the **[SLIP]** button again.

❖ Slip Manual Loop

- 1 Press the **[SLIP]** button.
The unit enters Slip mode.
- 2 Press the **[LOOP IN, 1/2X]** button, then press the **[LOOP OUT, 2X]** button.
Loop playback starts.
Normal playback continues in the background during loop playback.
- 3 Press the **[4 BEAT/EXIT]** button.
The loop is canceled and playback starts from the position reached in the background.
 - To cancel Slip mode, press the **[SLIP]** button again.

Using Fader Start

❖ Using Channel Fader Start

- 1 Set the cue point.

Pause the track at the position you want to start playback from, then press the **[CUE]** button on that deck.

- 2 While holding the **[SHIFT]** button, move the channel fader from the bottom to the top.

Playback starts from the cue point.

- If you move the channel fader back to the bottom while holding the **[SHIFT]** button during playback, the track instantly jumps back to the cue point and playback pauses (Back Cue).

When no cue point is set, playback starts from the beginning of the track.

❖ Using Crossfader Start

When you want to use the Crossfader Start function, set the crossfader assign switch of the channel to **[A]** or **[B]**.

- 1 Set the cue point.

Pause the track at the position you want to start playback from, then press the **[CUE]** button on that deck.

- 2 Move the crossfader all the way to the left or right side.

If you want to use Crossfader Start to trigger playback on channel 2, set the crossfader to the left side, and vice versa.

- 3 While holding the **[SHIFT]** button, move the crossfader towards the opposite side from where it's set.

Playback starts from the cue point.

- If you move the crossfader back while holding the **[SHIFT]** button during playback, the playback position instantly jumps back to the cue point and pauses (Back Cue).

When no cue point is set, playback starts from the beginning of the track.

Analyzing tracks

Track analysis starts when you drag and drop a music file, or a folder containing music files, into the Track List in Serato DJ Pro.

- If a track is loaded to a deck before analysis is complete, it may take some time to display its BPM and waveform.
- Depending on the number of tracks, analysis may take some time.

Using effects

Effects in Serato DJ Pro can be controlled with the unit.

Effects section display



1 Effect name

Displays the name of the selected effect.

2 AUTO / TAP

When the BPM measurement mode is Auto mode, **[AUTO]** is displayed. When it's Manual Input mode, **[TAP]** is displayed.

3 BPM value

Displays the automatically detected BPM in Auto mode.

If the BPM can't be detected, the previously detected BPM value flashes.

Displays the manually input BPM in Manual Input mode.

4 Selected channel

Displays the channel to which the effect will be applied. Displays **[SP]** (Sampler), **[MIC]**, **[CH 1]**, **[CH 2]**, **[CH 3]**, **[CH 4]**, or **[MST]** (Master) according to the selected channel.

5 Parameter

Displays parameters of the selected effect.

❖ Using an effect

- 1 Press the **[BEAT ◀]** button or **[BEAT ▶]** button while holding the **[SHIFT]** button.
 Select the BPM measurement mode.
 - **[AUTO]**: Press the **[BEAT ◀]** button while holding the **[SHIFT]** button. The BPM is automatically measured from the input audio signal.
 - **[TAP]**: Press the **[BEAT ▶]** button while holding the **[SHIFT]** button. Enter the BPM manually.

- 2 Turn the **[BEAT FX]** select knob.
 Selects a type of effect in Serato DJ Pro.

- 3 Turn the BEAT FX CH select knob.
 Selects a channel to apply the effect to.
 - **[SP]**: Applies the effect to the sampler sound.
 - **[MIC]**: Applies the effect to the microphone sound.
 - **[1]** to **[4]**: Applies the effect to the sound of the respective channel.
 - **[MST]**: Applies the effect to the sound of the master channel.
 - Set **[Sample Player Output Select]** to **[A]** in Serato DJ Pro.
 - For microphone sound and external input sound, the effect from the unit will be applied.
 - ➡ Read: Beat FX types on the unit (page 143)

- 4 Press the **[BEAT ◀]** button or **[BEAT ▶]** button.
 Sets the number of beats synchronized to the effect sound.
 The effect time corresponding to the number of beats is set automatically.

- 5 Press the **[BEAT FX ON/OFF]** button.
 The effect is applied to the sound.
 You can adjust the parameter of the effect by turning the **[BEAT FX LEVEL/DEPTH]** knob.
 The **[BEAT FX ON/OFF]** button flashes when the effect is on.
 - Press the **[BEAT FX ON/OFF]** button again to turn the effect off.

❖ Beat FX types on the unit

Beat FX	Explanation
LOW CUT ECHO	<p>Outputs the delay sound with the low frequency cut several times while attenuating it according to the number of beats.</p> <ul style="list-style-type: none"> • ◀ / ▶: Sets the delay time (number of beats) from 1/16 to 16 beats. • LEVEL/DEPTH: Sets the balance between the original sound and the echo sound.
ECHO	<p>Outputs the delay sound several times while attenuating it according to the number of beats.</p> <ul style="list-style-type: none"> • ◀ / ▶: Sets the delay time (number of beats) from 1/16 to 16 beats. • LEVEL/DEPTH: Sets the balance between the original sound and the echo sound.
MULTI TAP DELAY	<p>Outputs the delay sound up to 7 times in 1/8 beat units according to the number of beats.</p> <ul style="list-style-type: none"> • ◀ / ▶: Sets the effect time (number of beats) from 1/16 to 16 beats. • LEVEL/DEPTH: Sets the balance between the original sound and the effect sound.

Beat FX	Explanation
SPIRAL	<p>Adds a reverb effect to the input sound. When the delay time is changed, the pitch will also change at the same time.</p> <ul style="list-style-type: none"> • ◀ / ▶: Sets the delay time (number of beats) from 1/16 to 16 beats. • LEVEL/DEPTH: Sets the balance and feedback between the original sound and the effect sound.
REVERB	<p>Adds a reverb effect to the input sound.</p> <ul style="list-style-type: none"> • ◀ / ▶: Sets the reverb effect size (1 to 100%). • LEVEL/DEPTH: Sets the balance between the original sound and the effect sound.
TRANS	<p>Cuts the sound periodically according to the number of beats.</p> <ul style="list-style-type: none"> • ◀ / ▶: Sets the cycle (number of beats) to cut from 1/16 to 16 beats. • LEVEL/DEPTH: Sets the balance between the original sound and the effect sound and the length of time to cut the sound.
ENIGMA JET	<p>Creates a flanger effect in which the pitch continues to rise or fall according to the number of beats.</p> <ul style="list-style-type: none"> • ◀ / ▶: Sets the effect rate (number of beats). When you set from +1/16 to +64 beats, the pitch raises. When you set from -64 to -1/16 beats, the pitch lowers. • LEVEL/DEPTH: Sets how the effect applies.

Beat FX	Explanation
FLANGER	<p>Creates a one-cycle flanger effect according to the number of beats.</p> <ul style="list-style-type: none"> • ◀ / ▶: Sets the effect rate (number of beats) from 1/16 to 64 beats per beat of BPM. • LEVEL/DEPTH: Sets how the effect applies.
PHASER	<p>Changes the Phaser effect according to the number of beats.</p> <ul style="list-style-type: none"> • ◀ / ▶: Sets the effect rate (number of beats) from 1/16 to 64 beats. • LEVEL/DEPTH: Sets how the effect applies.
STRETCH	<p>Records the input sound when the effect is turned on, and outputs the recorded sound stretched to the set number of beats.</p> <ul style="list-style-type: none"> • ◀ / ▶: Sets the retrigger cycle (number of beats) from 1/16 to 16 beats. The input sound is recorded again according to the retrigger cycle. • LEVEL/DEPTH: Sets the number of beats of time-stretch.
SLIP ROLL	<p>Records the input sound when the effect is turned on, and outputs the recorded sound repeatedly according to the set number of beats. When the effect time changes, the input sound is recorded again.</p> <ul style="list-style-type: none"> • ◀ / ▶: Sets the effect time (number of beats) from 1/16 to 16 beats. • LEVEL/DEPTH: Sets the balance between the original sound and the effect sound.

Beat FX	Explanation
ROLL	<p>Records the input sound when the effect is turned on, and outputs the recorded sound repeatedly according to the set number of beats.</p> <ul style="list-style-type: none"> • ◀ / ▶: Sets the effect time (number of beats) from 1/16 to 16 beats. • LEVEL/DEPTH: Sets the balance between the original sound and the effect sound.
MOBIUS N (SAW)	<p>Creates a saw wave that sounds as if the pitch continues to rise or fall according to the number of beats.</p> <p>The sound mixed with the input sound outputs. The saw wave can output without input sound.</p> <ul style="list-style-type: none"> • ◀ / ▶: Sets the effect rate (number of beats). When setting between +1/16 and +64 beats, the pitch raises. When setting between -64 and -1/16 beats, the pitch lowers. • LEVEL/DEPTH: Sets the volume of the saw wave to be mixed.

Beat FX	Explanation
MOBIUS \wedge (TRI)	<p>Creates a triangular wave that sounds as if the pitch continues to rise or fall according to the number of beats.</p> <p>The sound mixed with the input sound outputs. It can oscillate even if there is no input sound.</p> <ul style="list-style-type: none">• \blacktriangleleft / \blacktriangleright: Sets the moving cycle of the effect (number of beats). When setting between +1/16 and +64 beats, the pitch raises. When setting between -64 and -1/16 beats, the pitch lowers.• LEVEL/DEPTH: Sets the volume of the triangular wave to be mixed.

Using Sound Color FX

You can apply effects that change as you turn the **[COLOR]** knob for each channel.

- For channels with external input sound, the unit's effects are applied.
 - ➡ Read: Sound Color FX types on the unit (page 148)
- 1 Press one of the **[SOUND COLOR FX]** buttons.

Selects an effect type.

The pressed button flashes.

 - If you already selected one button and then pressed another, the newly pressed button is selected.
 - The same effect is set for all channels.
 - 2 Turn a **[COLOR]** knob.

The effect is applied to that channel.

❖ Canceling Sound Color FX

Press the flashing **[SOUND COLOR FX]** button.
The effect is canceled.

❖ Sound Color FX types on the unit

Effect	Explanation
SPACE	<p>Gives a reverb effect.</p> <ul style="list-style-type: none"> • COLOR: <ul style="list-style-type: none"> Turn counterclockwise: Applies the reverb effect to the mid-range and low-range. Turn clockwise: Applies the reverb effect to the mid-range and high-range.

Effect	Explanation
DUB ECHO	<p>Outputs delayed sound repeatedly while attenuating it and gives an echo effect.</p> <ul style="list-style-type: none"> • COLOR: <ul style="list-style-type: none"> Turn counterclockwise: Applies the echo effect to the mid-range. Turn clockwise: Applies the echo effect to the high-range.
CRUSH	<p>Changes the output sound so it sounds like it's "crushing".</p> <ul style="list-style-type: none"> • COLOR: <ul style="list-style-type: none"> Turn counterclockwise: Applies "crushed" effect to the sound. Turn clockwise: Crushes sound, and then applies the high-pass filter effect.
PITCH	<p>Changes the pitch.</p> <ul style="list-style-type: none"> • COLOR: <ul style="list-style-type: none"> Turn counterclockwise: The pitch falls. Turn clockwise: The pitch rises.
NOISE	<p>Outputs white noise generated inside the unit mixed into the sound of the channel via the filter.</p> <ul style="list-style-type: none"> • COLOR: <ul style="list-style-type: none"> Turn counterclockwise: Gradually decreases the cut-off frequency of the filter through which the white noise passes. Turn clockwise: Gradually increases the cut-off frequency of the filter through which the white noise passes.

Effect	Explanation
FILTER	Outputs sound that has passed through a filter. <ul style="list-style-type: none"> • COLOR: <ul style="list-style-type: none"> Turn counterclockwise: Gradually decreases the low-pass filter's cut-off frequency. Turn clockwise: Gradually increases the high-pass filter's cut-off frequency.

Using FX Part Select

The effect applies to the selected Stem (Drums / Vocal / Bass & Melody) of the loaded track.

- The effect applies to all Stems when using sound from the external inputs, microphone, or sampler.

1 Select a Stem, or multiple Stems, with the **[FX PART SELECT]** buttons.

Press **[DRUMS]**, **[VOCAL]**, or **[INST]** (Bass & Melody) button and the button will light up. The effect applies to all Stems with lit buttons.

2 Apply an effect.

When the sound is applied with Beat FX or Sound Color FX, the effect applies to the selected Stem only.

➡ Read: Using an effect (page 142)

➡ Read: Using Sound Color FX (page 148)

To cancel FX Part Select

When all **[FX PART SELECT]** (**[VOCAL]**, **[DRUMS]**, **[INST]**) buttons light up, the effect applies to all Stems, which means FX Part Select is canceled.

Recording

Serato DJ Pro has a recording feature that you can use to capture your performances. For detailed instructions on recording, see the Serato DJ Pro software manual.

- 1 Click **[REC]** in the upper area of the Serato DJ Pro screen.
The **[REC]** panel is displayed.
- 2 Click **[REC]** in the **[REC]** panel to start recording.
 - If you click **[REC]** again, recording stops.
 - When recording is complete, the file is automatically saved.

Using a microphone

- 1 Connect a microphone to the **[MIC 1]** input terminal or **[MIC 2]** input terminal.
- 2 Set the **[MIC OFF, ON, TALKOVER]** switch to **[ON]** or **[TALKOVER]**.
 - **[ON]**: The indicator lights up.
 - **[TALKOVER]**: The indicator flashes.
 - When you set the switch to **[TALKOVER]**, the sound of channels other than the **[MIC1]** channel and **[MIC2]** channel is attenuated by -18 dB (default) when a sound of -10 dB or greater is input to the microphone.
 - The level of attenuation applied when you set the switch to **[TALKOVER]** can be changed in Utilities mode. For details on how to change this setting, read: Launching Utilities mode (page 154)
 - You can switch Talkover mode between Normal mode and Advanced mode. For details on how to change this setting, read: Launching Utilities mode (page 154)
- 3 Turn the **[MIC 1 LEVEL]** knob or **[MIC 2 LEVEL]** knob.
Adjust the volume of the sound output from the **[MIC 1]** input terminal or **[MIC 2]** input terminal.

- The sound comes out at a high volume if the knob is turned all the way to the right.

4 Speak into the microphone.

- You can't affect the microphone sound input to the unit in Serato DJ Pro.

❖ Adjusting the sound

Turn the **[MIC EQ (HI, LOW)]** knobs.





- **[HI]**: -12 dB to +12 dB (10 kHz)
- **[LOW]**: -12 dB to +12 dB (100 Hz)

Using external inputs



The unit has four sets of external inputs to connect multi players, turntables, etc. The “4-channel mixer” of the unit can be used to mix input sound without it passing through your PC/Mac. You can use the following mixer features even when not connected to a PC/Mac.

- For details on the respective items, read: Connecting (page 66) and Part names and functions (page 10)

❖ Mixing the sound of a multi player, etc.

- 1 Connect a multi player or other line-level output device to the **[LINE]** input terminal or the **[LINE/PHONO]** input terminal.
- 2 Set the **[LINE/PHONO]** switch on the unit's rear panel to **[LINE]**.
- 3 Set the **[ A, LINE,  B]** switch or **[ A, PHONO/LINE,  B]** switch on the unit's top panel to **[LINE]** or **[PHONO/LINE]**.
- 4 Turn the **[TRIM]** knob and move the channel fader to adjust the volume of the sound output from each channel.

❖ **Mixing the sound of turntables, etc.**

- 1 Connect turntables or other phono-level (MM cartridge) output devices to the **[LINE/PHONO]** input terminals of **[CH3]** or **[CH4]**.
 - **[CH1]** and **[CH2]** are input terminals for line-level devices only.
 - Be sure to connect the ground wire of the turntable to the **[SIGNAL GND]** terminal of the unit.
- 2 Set the **[LINE/PHONO]** switch on the unit's rear panel to **[PHONO]**.
- 3 Set the [ **A, PHONO/LINE**,  **B**] switch on the unit's top panel to **[PHONO/LINE]**.
- 4 Turn the **[TRIM]** knob and move the channel fader to adjust the volume of the sound output from each channel.

Setting the crossfader curve

You can set the crossfader curve on the Serato DJ Pro screen.

- 1 Click  in Serato DJ Pro.
- 2 Click the **[Mixer]** tab.
- 3 Adjust the crossfader curve.
 - The more you turn it toward **[SLOW]**, the more gradual the rise of the curve.
 - The more you turn it toward **[FAST]**, the sharper the rise of the curve.

Changing the settings

Launching Utilities mode

Use Utilities mode to change the settings of the unit.

If the unit is connected to your PC/Mac while it's running rekordbox, you won't be able to use Utilities mode.

To change the settings when connected to rekordbox, change them on the Preferences screen in rekordbox.

➡ Read: Changing the settings in rekordbox (page 107)

- 1 Press and hold down the **[BACK]** button.
The settings screen appears on the On Jog Display.
- 2 Turn the rotary selector to select a setting item.
- 3 Press the rotary selector to confirm the selection.
The screen for changing the setting appears.
- 4 Turn the rotary selector to select a setting value.
- 5 Press the rotary selector to confirm the selection.
 - Press the **[BACK]** button to cancel the setting.
- 6 Press the **[BACK]** button.
The settings screen for Utilities mode closes.

Changing the settings

Utilities mode settings

*: Default

Setting item	Explanation
AUTO STANDBY	Sets the auto standby function (page 157). <ul style="list-style-type: none">• Setting values: OFF, ON*
DEMO/S.SAVER	Sets the amount of time until demo mode or the screen saver starts. <ul style="list-style-type: none">• Setting values: DISABLE, DEMO 1min, DEMO 5min, DEMO 10min*, S.SAVER• S.SAVER: Starts the screen saver if no operation is performed for 30 minutes.
TALKOVER MODE	Sets the Talkover mode for the microphone (page 158). <ul style="list-style-type: none">• Setting values: ADVANCED*, NORMAL
TALKOVER LEVEL	Sets the talkover level for the microphone. <ul style="list-style-type: none">• Setting values: -6dB, -12dB, -18dB*, -24dB
PHONES OUT	Sets the output method for the [PHONES] output terminal. <ul style="list-style-type: none">• Setting values: STEREO*, MONO SPLIT
SPLIT CUE OUTPUT	Sets the L/R outputs of sound from the [PHONES] output terminal when [MONO SPLIT] is selected on the [PHONES OUT] setting. <ul style="list-style-type: none">• Setting values: NORMAL*, INVERT
MIC TO BOOTH	Determines whether or not to output the microphone sound from the [BOOTH] output terminals. <ul style="list-style-type: none">• Setting values: OFF, ON*

Changing the settings

Setting item	Explanation
MIC LMT (MSTR)	Sets whether or not to use the limiter for the microphone sound input to the master output sound. • Setting values: OFF, ON*
MIC LMT (BOOTH)	Sets whether or not to use the limiter for the microphone sound input to sound to the [BOOTH] output terminals. • Setting values: OFF, ON*
MASTER ATT.	Sets the attenuation level of the sound from the [MASTER 1] and [MASTER 2] output terminals. • Setting values: 0dB*, -6dB, -12dB
MASTER OUT	Sets the output method for the sound from the [MASTER 1] and [MASTER 2] output terminals. • Setting values: STEREO*, MONO
MASTER LIMITER	Reduces distortion to the sound from the [MASTER 1] and [MASTER 2] terminals. • Setting values: OFF, ON*
BOOTH ATT.	Sets the attenuation level of the sound from the [BOOTH] output terminals. • Setting values: 0dB*, -6dB, -12dB
BOOTH OUT	Sets the output method for the sound from the [BOOTH] output terminals. • Setting values: STEREO*, MONO
JOG RING BRT.	Sets the brightness of the jog ring illumination. • Setting values: OFF, 1, 2, 3*
JOG DISP. BRT.	Sets the brightness of the On Jog Display. • Setting values: 1, 2, 3, 4, 5*

Changing the settings

Setting item	Explanation
DISPLAY BRT.	Sets the brightness of the effects section display. <ul style="list-style-type: none">• Setting values: 1, 2, 3*
CR FDR CUT LAG	Adjusts the range where no sound is heard at both edges of the crossfader (cut lag). <ul style="list-style-type: none">• Setting values: 0 - 6, 7*, 8 - 52
FACTORY RESET	Select [RESET] to restore the factory settings. <ul style="list-style-type: none">• Setting values: CANCEL*, RESET

Auto standby

When **[AUTO STANDBY]** is set to **[ON]**, the unit enters Standby mode automatically after 4 hours without being used (no audio signal (more than -24 dB) is input to the unit).

Press the **[QUANTIZE]** button on the left deck to cancel Standby mode.

- The factory setting is **[ON]**.
- Set **[AUTO STANDBY]** to **[OFF]** if you don't need to use the auto standby function.

Talkover mode

- **[ADVANCED]:**

Only the mid-range sound, other than the microphone channel, is attenuated according to the set value of the Talkover level.

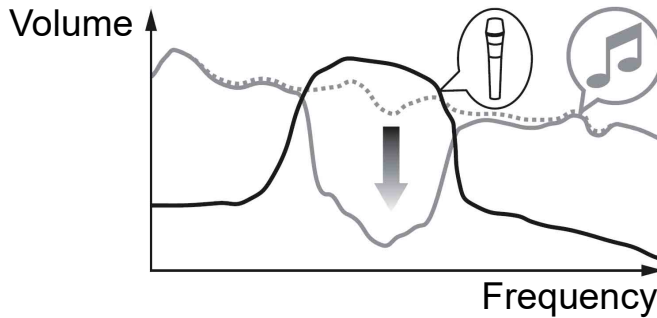

- **[NORMAL]:**

Sound, other than the microphone channel, is attenuated according to the set value of the Talkover level.

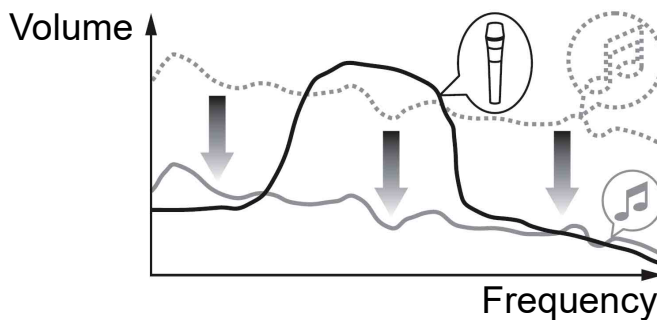

Setting Utility software

You can use the Setting Utility to perform checks and change settings for connections between the unit and your PC/Mac.

Displaying the Setting Utility

For Mac

In Finder, open the **[Applications]** folder, then click the **[Pioneer] > [DDJ-FLX10] > [DDJ-FLX10 Setting Utility]**.

For Windows 11

In the **[Start]** menu, open the **[All apps]** screen, then click **[Pioneer] > [DDJ-FLX10 Setting Utility]**.

For Windows 10

In the **[Start]** menu, click **[Pioneer] > [DDJ-FLX10 Setting Utility]**.

Adjusting the buffer size (when using Windows ASIO)

- If an application (DJ software, etc.) is running and using the unit as the default audio device, quit the application before adjusting the buffer size.
- 1 Click the **[ASIO]** tab.
 - 2 Adjust the buffer size with the slider.

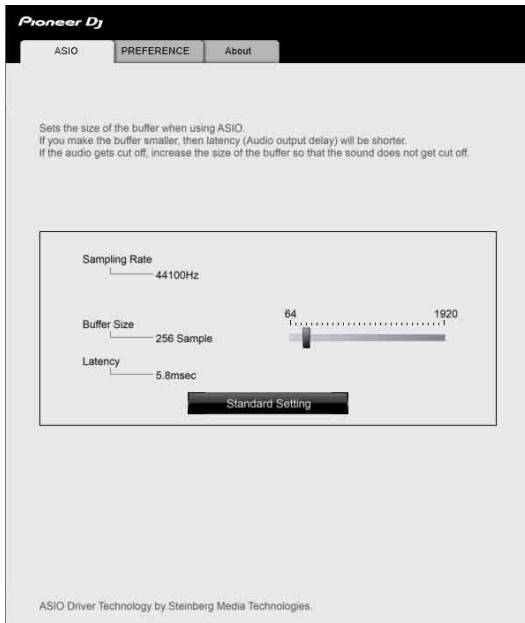

- If a large buffer size is set, drops in audio data (breaks in the sound) are less likely to happen, but the time lag due to the delay in the transfer of the audio data (latency) increases.

Changing the settings in the Setting Utility

When using rekordbox, change the settings on the Preferences screen in rekordbox.

➡ Read: Changing the settings in rekordbox (page 107)

- 1 Click the **[PREFERENCE]** tab.
- 2 Change the settings.

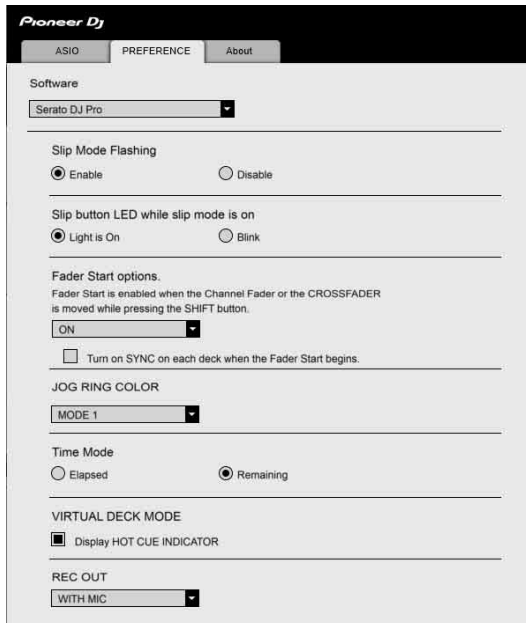

Setting item	Explanation
Software	The way setting items are arranged on this tab depends on the software selected.
Slip Mode Flashing	Selects whether to enable or disable the function that flashes the LEDs of related controls when Slip mode is on (when [Serato DJ Pro] is selected as the software).

Changing the settings

Setting item	Explanation
Slip button LED while Slip mode is on	<p>Sets the lighting of the [SLIP] button when Slip mode is on (when [Serato DJ Pro] is selected as the software).</p> <p>Light is on: Lights when Slip mode is on, and flashes when Slip is being used.</p> <p>Blink: Flashes constantly when Slip mode is on.</p>
Fader Start options	<p>Select [ON] to enable the Fader Start function (when [Serato DJ Pro] or [Other software] is selected as the software). Check the checkbox to also enable the Sync function when using Fader Start.</p> <p>➡ Read: Using Fader Start (page 139)</p>
JOG RING COLOR	<p>Selects the lighting color of the jog ring illumination from [MODE 1], [MODE 2], and [MODE 3] (when [Serato DJ Pro] is selected as the software).</p>
Time Mode	<p>Sets the time display format ([Elapsed] or [Remaining]) on the Waveform mode screen of the On Jog Display (when [Serato DJ Pro] is selected as the software).</p>
Display HOT CUE INDICATOR	<p>Displays Hot Cues on Virtual Deck mode of the On Jog Display (when [Serato DJ Pro] is selected as the software).</p> <p>If this setting isn't selected, Hot Cue information is displayed the same as it is on Serato DJ Pro's virtual deck when Virtual Deck mode is selected.</p>
REC OUT	<p>Sets the microphone's output ([WITH MIC] or [WITHOUT MIC]) for recording (when [Serato DJ Pro] or [Other software] is selected as the software).</p>

Checking the version of the firmware and the dedicated software

- 1 Click the **[About]** tab.



- You can change the image for DJ Logo on this tab.

❖ Setting the image for DJ Logo

Set the image to display on DJ Logo Display of the On Jog Display.

- 1 Click **[Setting]**.
[DDJ-FLX10 Image Transfer Tool] starts.
- 2 Click **[Open]**.
- 3 Select an image (bmp / jpeg / png / gif format) to display on the On Jog Display.
- 4 Click **[Transfer]**.
The selected image is transferred to the unit and set.

Changing the settings

- 5 Switch to DJ Logo Display (page 48) and make sure that the set image is displayed of the On Jog Display.
 - To delete the set image, click **[Delete]** in **[DDJ-FLX10 Image Transfer Tool]**.
 - Before using **[DDJ-FLX10 Image Transfer Tool]**, quit your DJ software.

Additional information

Troubleshooting

If you think something is wrong with the unit, check the information below and refer to the **[FAQ]** for the DDJ-FLX10 on the Pioneer DJ website.

pioneerdj.com/support/

Sometimes, the problem may be caused by another device. Inspect the other devices and electrical appliances you're using and refer to their manuals and FAQ if necessary. If the problems continue, read the Precautions for Use and consult an authorized service company or your dealer.

- The unit may not work properly if it's subjected to static electricity or other external influences. In this case, turn the unit off and on again to restore proper operation.

Power

❖ The unit does not power up.

- Check the power cord is connected properly.
- Press the **[⏻]** switch on the unit's rear panel to turn the unit on.





Connection

❖ **The unit isn't recognized by your PC/Mac.**

- Connect the supplied USB cable correctly. See: Connections (page 62)
- When using a USB hub, be sure it's a product recommended by the manufacturer of your PC/Mac.
- If another USB device is connected to your PC/Mac, disconnect it.
- Install the dedicated audio driver software and/or Setting Utility on your PC/Mac. If it has already been installed, install it again. See: PC/Mac setup (page 8)
- Quit any other open applications including screen savers and antivirus security software on your PC/Mac. (When quitting antivirus security software, before doing so, disable the internet connection to ensure the security of your PC/Mac.)
- For Windows, if multiple ASIO drivers other than the ones used by this unit are installed on your PC, uninstall unnecessary ASIO drivers.
- Check if the unit's firmware version can be displayed in the Setting Utility (page 159).

Sound

❖ **Sound isn't output, is too quiet, or is distorted.**

- Set the [ **A, PHONO/LINE**,  **B**] switch, [ **A, LINE**,  **B**] switch, [**LINE/PHONO**] switch, [**TRIM**] knob, channel fader, crossfader, and [**MASTER LEVEL**] knob to the correct positions. See: Playing a track (page 73) (page 121)
- Connect the connection cable properly. See: Connections (page 62)
- Clean the terminals and plugs before connecting the cable to the unit.
- For Mac, change the buffer size (latency) for your DJ software.
- For Windows, change the buffer size in the Setting Utility (page 159).

❖ **Microphone sound can't be output.**

- Set the [**MIC OFF, ON, TALKOVER**] switch to the correct position (page 104)(page 151).

❖ **Sound from the Sampler deck can't be monitored with the headphones.**

- Set the [**SAMPLER VOL**] knob to the correct position.
- For Serato DJ Pro, set [**Sample Player Output Select**] to [**A**].

rekordbox

❖ rekordbox becomes unstable.

- Update rekordbox to the latest version. See: Installing rekordbox (page 67)
- Quit any other applications on your PC/Mac. If rekordbox remains unstable, try disabling the wireless network or other wireless connections, antivirus software, screen saver, low-power mode, etc. (When quitting antivirus security software, before doing so, disable the internet connection to ensure the security of your PC/Mac.)
- If another USB device is connected to your PC/Mac, disconnect it.
- When using a USB hub, be sure it's a product recommended by the manufacturer of your PC/Mac.
- If you're using battery power for your laptop, connect the laptop to an AC power supply.

❖ rekordbox can't be controlled by the unit./The platter isn't displayed on the deck./Settings described in this manual aren't displayed.

- Click **[EXPORT]** at the top-left corner of the rekordbox screen to switch to **[PERFORMANCE]** mode.

❖ BPM and beatgrid are not displayed correctly./Beatgrid is misaligned.

- Change the BPM analysis range and analyze the track again. If it doesn't work, manually set the beatgrid and BPM.
- Adjust the beatgrid. For details on how to adjust the beatgrid, see the rekordbox Instruction Manual.

❖ Sound is interrupted while using rekordbox.

- Set the buffer size in **[Preferences]** > **[Audio]** in rekordbox.

❖ **Fader Start doesn't work.**

- Set a cue.
- To activate Fader Start, mark the **[Fader Start]** check box in **[Preferences] > [Controller] > [Mixer]** tab in rekordbox.

❖ **When the unit is disconnected, recording isn't available in rekordbox.**

- If you don't have one of the relevant subscription plans, you can't record without connecting to the unit. Connect the unit or another Hardware Unlock device, or take out one of the relevant subscription plans to enable recording.

Lighting fixtures

❖ **A Lighting fixture doesn't work with the unit.**

- The **[DMX]** output terminal of the unit is for use with rekordbox Lighting mode only.

Check the channel setting of the lighting fixture and that the cable is connected properly.

Next, check the channel setting and relevant lighting fixture is mapped to the correct channel on the **[FIXTURE LIBRARY]** screen of the **[LIGHTING]** mode screen in rekordbox.

If the mapped item is automatically displayed as **[No Assign]** in the pull-down menu of the window on the right, the lighting fixture may not be supported by rekordbox. (In this case, change **[No Assign]** to the other setting, which may solve the problem.)

Serato DJ Pro

❖ Serato DJ Pro becomes unstable.

- Update Serato DJ Pro to the latest version. See: Installing Serato DJ Pro (page 114)
- Quit any other applications on your PC/Mac. If Serato DJ Pro remains unstable, try disabling the wireless network or other wireless connections, antivirus software, screen saver, low-power mode, etc. (When quitting antivirus security software, before doing so, disable the internet connection to ensure the security of your PC/Mac.)
- If another USB device is connected to your PC/Mac, disconnect it.
- When using a USB hub, be sure it's a product recommended by the manufacturer of your PC/Mac.
- If you're using battery power for your laptop, connect the laptop to an AC power supply.

❖ Tracks aren't displayed in the library.

- Import music files. For details about importing music files (tracks), see: Importing music files (tracks) (page 119)
- If you selected a crate or subcrate which doesn't contain any tracks, select another crate or subcrate which does contain tracks, or import tracks into the crate or subcrate.

❖ iTunes tracks aren't displayed in the library.

- Activate **[Show iTunes Library]** in the **[Library + Display]** tab of the **[]** menu. If **[Show iTunes Library]** is already activated, deactivate it, then activate it again. For details about importing music files, see the Serato DJ Pro software manual.
- If you selected a crate or subcrate which doesn't contain any tracks, select another crate or subcrate which does contain tracks, or import tracks into the crate or subcrate.

- ❖ **Music files in the library can't be edited (such as changing the track name).**
 - Deactivate **[Protect Library]** in the **[Library + Display]** tab of the **[]** menu.

- ❖ **Serato DJ Pro virtual deck isn't displayed. (Offline player is displayed.)**
 - Connect the supplied USB cable correctly. See: Connections (page 62)
 - Update Serato DJ Pro to the latest version. See: Installing Serato DJ Pro (page 114)

- ❖ **BPM isn't displayed./Sync and Auto Loop don't work.**
 - Mark the **[Set Beat Grid / BPM]** check box in **[Analysis Settings]** of the offline player setting, then analyze the track. For details on how to analyze a track, see the Serato DJ Pro software manual.

- ❖ **BPM and beatgrid are not displayed correctly./Beatgrid is misaligned.**
 - Change the BPM analysis range and analyze the track again. If it still doesn't work, manually set the beatgrid and BPM.
 - Adjust the beatgrid. For details on how to adjust the beatgrid, see the Serato DJ Pro software manual.

- ❖ **Sound is interrupted while using Serato DJ Pro**
 - For Mac, change the Serato DJ Pro buffer size (latency).
 - For Windows, change the buffer size in the Setting Utility (page 159).

- ❖ **BPM is displayed, but the beatgrid isn't displayed./Skip mode doesn't work.**
- Mark the **[Set Beat Grid / BPM]** check boxes in **[Analysis Settings]** of the offline player setting, then analyze the track. For details on how to analyze a track, see the Serato DJ Pro software manual.
- Set the beatgrid. For details on how to set the beatgrid, see the Serato DJ Pro software manual.

Others

- ❖ **The indicator flashes and the unit doesn't seem to be working properly.**
- If the unit behaves unusually or doesn't turn on, disconnect the power cord from the power outlet, wait a while, then turn on the unit with reconnecting the power cord. If it still doesn't work, consult an authorized service company or your dealer.

LCD display

- Small black or shining points may appear on the LCD display. This is a phenomenon inherent to LCD displays and not a malfunction.
- When using the unit in cold places, the LCD display may be dark for a while after the power is turned on. Normal brightness will restore after a while.
- When the LCD display is exposed to direct sunlight, the light will reflect off it, making it difficult to see. Block the direct sunlight to improve visibility of the display.

Cleaning

Wipe with a dry soft cloth.

- Do not use organic solvents, acids, or alkalis for cleaning.

Signal flow

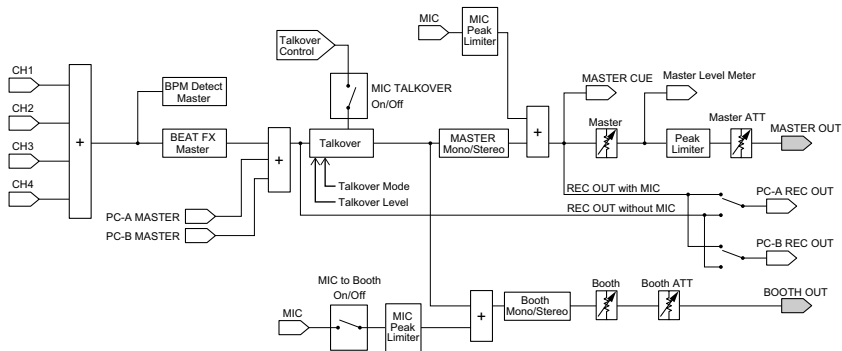
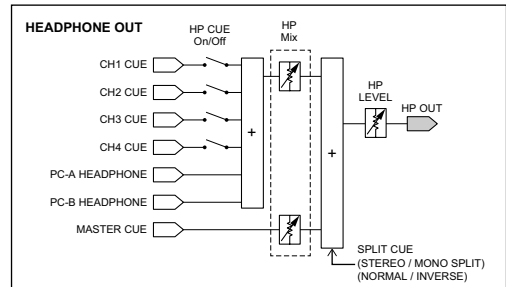
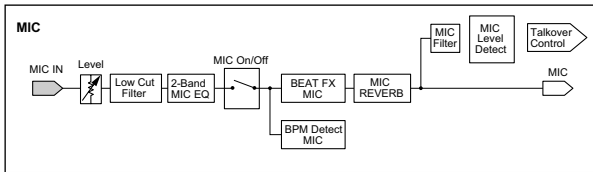
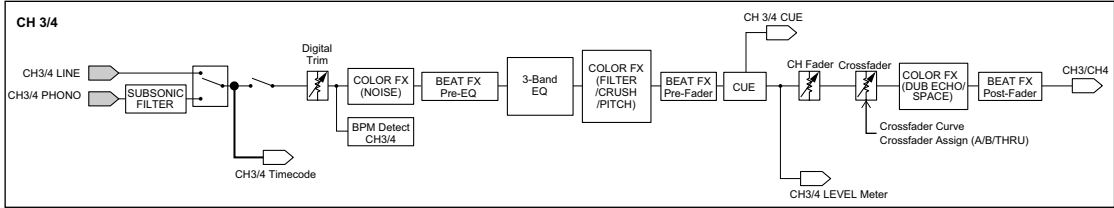
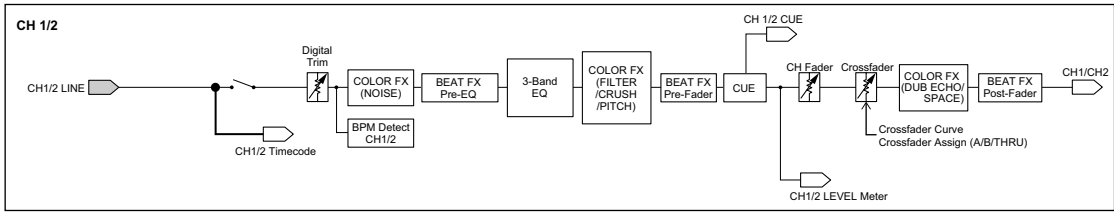

— USB Audio Stream In USB A
 - - - - - USB Audio Stream In USB B

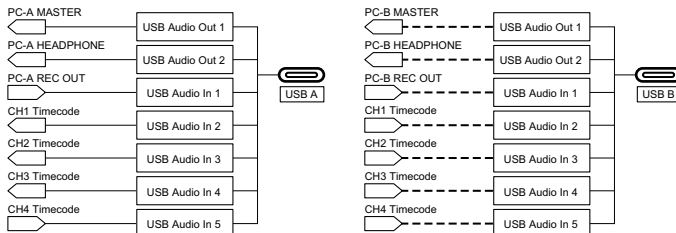

Specifications

AC adapter

Power requirements	AC 100 V – 240 V, 50 Hz / 60 Hz
Rated current.....	0.9 A
Rated output	DC 12 V, 3 A

General – Main Unit

Power consumption	DC 12 V, 1 800 mA
Main unit weight.....	6.7 kg / 14.8 lbs.
Max. external dimensions (W x D x H)	
.....	716 x 400.3 x 73.4 mm / 28.2" x 15.8" x 2.9"
Tolerable operating temperature.....	+5 °C – +35 °C (+41 °F – +95 °F)
Tolerable operating humidity.....	5 % – 85 % (no condensation)

Audio Section

Sampling rate	44.1 kHz
A/D, D/A converters	24 bit
Frequency characteristic	
USB, LINE, MIC1, MIC2	20 Hz – 20 kHz
S/N ratio (rated output, A-WEIGHTED)	
USB	110 dB
LINE	94 dB
PHONO	83 dB
MIC 1	81 dB
MIC 2	81 dB
Total harmonic distortion (20 Hz to 20 kHz BW)	
USB	0.002 %
LINE	0.007 %
PHONO	0.025 %
Standard input level / Input impedance	
LINE	-12 dBu / 47 kΩ
PHONO	-52 dBu / 47 kΩ

Additional information

MIC 1 -57 dBu / 3 k Ω
MIC 2 -57 dBu / 3 k Ω

Standard output level / Load impedance / Output impedance

MASTER 1 +6 dBu / 10 k Ω / 330 Ω or less
MASTER 2 +2 dBu / 10 k Ω / 750 Ω or less
BOOTH +6 dBu / 10 k Ω / 900 Ω or less
PHONES +8 dBu / 32 Ω / 10 Ω or less

Rated output level / Load impedance

MASTER 1 +25 dBu / 10 k Ω
MASTER 2 +21 dBu / 10 k Ω
BOOTH +25 dBu / 10 k Ω

Crosstalk

LINE 88 dB
PHONO 77 dB

Channel equalizer characteristic

HI -26 dB - +6 dB (20 kHz)
MID -26 dB - +6 dB (1 kHz)
LOW -26 dB - +6 dB (20 Hz)

Microphone equalizer characteristic

HI -12 dB - +12 dB (10 kHz)
LOW -12 dB - +12 dB (100 Hz)

DMX Section

DMX channel 1 universe (512 ch)

Input / Output terminals

LINE input terminals

RCA pin jacks 2 sets

LINE / PHONO input terminals

RCA pin jacks 2 sets

MIC input terminals

XLR connector & 1/4" TRS jack 1 set

1/4" TRS jack 1 set

Additional information

MASTER 1 output terminal	
XLR connector	1 set
MASTER 2 output terminal	
RCA pin jacks	1 set
BOOTH output terminal	
1/4" TRS jacks	1 set
PHONES output terminals	
1/4" stereo jack	1 set
3.5 mm stereo mini jack.....	1 set
USB ports	
USB Type-C.....	2 sets
DMX terminals	
XLR connector (3 pins).....	1 set

Specifications of external power supply (for European Union customers)

Manufacturer's name	ALPHATHETA EMEA LIMITED
Commercial registration number	09230173
Address	Artemis, Odyssey Business Park, West End Road, South Ruislip, England, HA4 6QE
Model identifier	UNI336-1230
Input voltage	AC 100 V to 240 V
Input AC frequency	50 Hz / 60 Hz
Output voltage	DC 12.0 V
Output current.....	3.0 A
Output power	36.0 W
Average active efficiency	88.7 %
Efficiency at low load (10 %)	84.9 %
No-load power consumption.....	0.04 W

Information requirements of the European Ecodesign Directive

- Be sure to use the **[MASTER 1]** output terminals for a balanced output.

Additional information

If these terminals are connected to an unbalanced input (such as RCA) using an XLR to RCA converter cable (or converter adapter), etc., the sound quality may be lowered or unwanted noise may occur.

- For connection with an unbalanced input (such as RCA), use the **[MASTER 2]** output terminals.
- Be sure to use the **[BOOTH]** output terminals for a balanced output. If these terminals are connected to an unbalanced input (such as an RCA or TS terminal) with a TRS to RCA converter cable (or converter adapter), TS cable, etc., the sound quality may be lowered or unwanted noise may occur.
- The specifications and design of this product are subject to change without notice.

Using the unit as a controller for other DJ applications

The unit also outputs operating data for the buttons and knobs in MIDI format. If you connect a PC/Mac with a built-in MIDI-compatible DJ application via the USB cable, you can control the DJ application other than rekordbox and Serato DJ Pro with the unit. (You need to set MIDI details in the DJ application.)

- For details, see your DJ application's user guide.
- To play tracks stored in Windows on the unit, install the dedicated audio driver software on your PC in advance (page 8).
- Some buttons on the unit may not be used to operate the DJ software.

About MIDI messages

For details on the unit's MIDI messages, see the List of MIDI Messages.

- You can find the List of MIDI Messages on the website below.
pioneerdj.com/support/

Trademarks and registered trademarks

- Pioneer DJ is a trademark of PIONEER CORPORATION and is used under license.
- rekordbox™ is a trademark or registered trademark of AlphaTheta Corporation.
- iTunes, Mac, macOS and Finder are trademarks of Apple Inc., registered in the U.S. and other countries and regions.
- Windows is a registered trademark of Microsoft Corporation in the United States and other countries.
- ASIO is a trademark or registered trademark of Steinberg Media Technologies GmbH.
- Serato DJ Pro, Scratch Live, ITCH and Serato DJ Intro are registered trademarks of Serato Limited.

Other product, technology and company names, etc. mentioned herein are trademarks or registered trademarks of their respective owners.

About using MP3 files

This product has been licensed for nonprofit use. This product has not been licensed for commercial purposes (for profit-making use), such as broadcasting (terrestrial, satellite, cable or other types of broadcasting), streaming on the Internet, Intranet (a corporate network) or other types of networks or distributing of electronic information (online digital music distribution service). You need to acquire the corresponding licenses for such uses. For details, refer to <http://www.mp3licensing.com>.

Software license notice

- This software is based in part on the work of the Independent JPEG Group.

Apache

Copyright (c) 2009-2019 ARM Limited. All rights reserved.

SPDX-License-Identifier: Apache-2.0

Licensed under the Apache License, Version 2.0 (the License); you may not use this file except in compliance with the License.

You may obtain a copy of the License at

www.apache.org/licenses/LICENSE-2.0

Unless required by applicable law or agreed to in writing, software distributed under the License is distributed on an AS IS BASIS, WITHOUT WARRANTIES OR CONDITIONS OF ANY KIND, either express or implied.

See the License for the specific language governing permissions and limitations under the License.

BSD

The BSD-3-Clause License

Copyright (c) 2015, Freescale Semiconductor, Inc.

Copyright 2016-2020 NXP

All rights reserved.

Redistribution and use in source and binary forms, with or without modification, are permitted provided that the following conditions are met:

1. Redistributions of source code must retain the above copyright notice, this list of conditions and the following disclaimer.

Additional information

2. Redistributions in binary form must reproduce the above copyright notice, this list of conditions and the following disclaimer in the documentation and/or other materials provided with the distribution.
3. Neither the name of the copyright holder nor the names of its contributors may be used to endorse or promote products derived from this software without specific prior written permission.

THIS SOFTWARE IS PROVIDED BY THE COPYRIGHT HOLDERS AND CONTRIBUTORS "AS IS" AND ANY EXPRESS OR IMPLIED WARRANTIES, INCLUDING, BUT NOT LIMITED TO, THE IMPLIED WARRANTIES OF MERCHANTABILITY AND FITNESS FOR A PARTICULAR PURPOSE ARE DISCLAIMED. IN NO EVENT SHALL THE COPYRIGHT HOLDER OR CONTRIBUTORS BE LIABLE FOR ANY DIRECT, INDIRECT, INCIDENTAL, SPECIAL, EXEMPLARY, OR CONSEQUENTIAL DAMAGES (INCLUDING, BUT NOT LIMITED TO, PROCUREMENT OF SUBSTITUTE GOODS OR SERVICES; LOSS OF USE, DATA, OR PROFITS; OR BUSINESS INTERRUPTION) HOWEVER CAUSED AND ON ANY THEORY OF LIABILITY, WHETHER IN CONTRACT, STRICT LIABILITY, OR TORT (INCLUDING NEGLIGENCE OR OTHERWISE) ARISING IN ANY WAY OUT OF THE USE OF THIS SOFTWARE, EVEN IF ADVISED OF THE POSSIBILITY OF SUCH DAMAGE.

Cautions on copyrights

rekordbox restricts playback and duplication of copyright-protected music contents.

- When coded data, etc., for protecting the copyright is embedded in the music contents, it may not be possible to operate the program normally.
- When rekordbox detects that coded data, etc., for protecting the copyright is embedded in the music contents, processing (playback, reading, etc.) may stop.

Recordings you have made are for your personal enjoyment and according to copyright laws may not be used without the consent of the copyright holder.

- Music recorded from CDs, etc., is protected by the copyright laws of individual countries and by international treaties. It is the full responsibility of the person who has recorded the music to ensure that it is used legally.
- When handling music downloaded from the Internet, etc., it is the full responsibility of the person who has downloaded the music to ensure that it is used in accordance with the contract concluded with the download site.

The specifications and design of this product are subject to change without notice.

© 2023 AlphaTheta Corporation

All rights reserved.

<DRI1822-A>