

# Instruction Manual

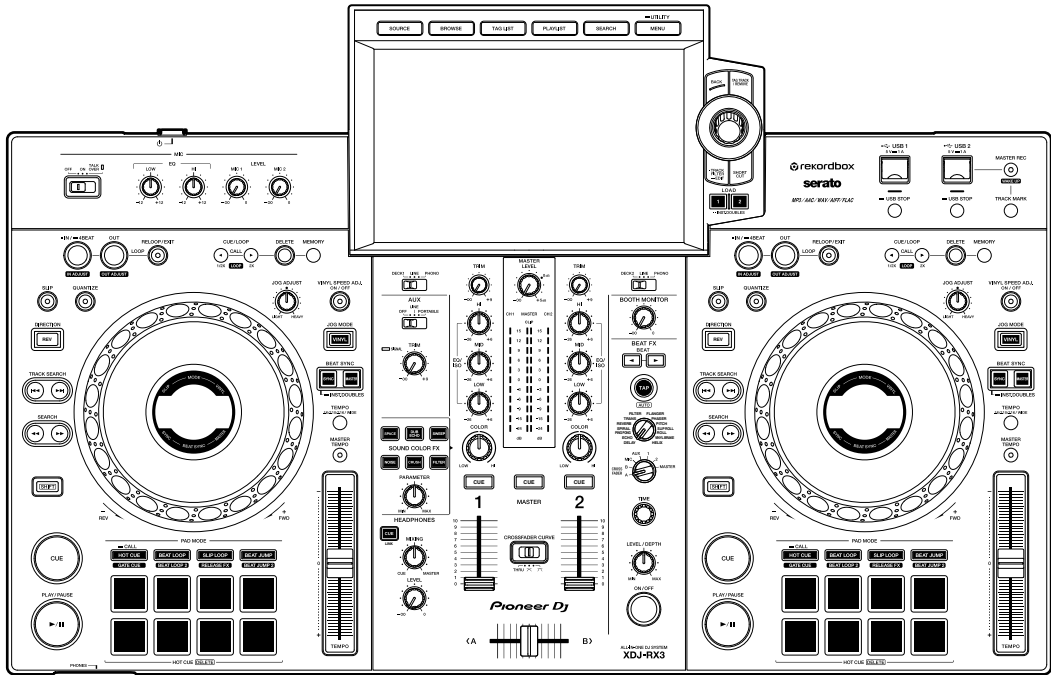

All-In-One DJ System

# XDJ-RX3

[pioneerdj.com/support/](http://pioneerdj.com/support/)

[rekordbox.com](http://rekordbox.com)

[serato.com](http://serato.com)

For FAQs and other support information for this product, visit the websites above.

**Pioneer Dj**

**serato**

---

---

# Contents

<b>Before you start</b> .....	<b>7</b>
How to read this manual .....	7
What's in the box.....	7
User guides .....	8
<b>Product overview</b> .....	<b>9</b>
System requirements .....	9
rekordbox .....	11
PRO DJ LINK .....	12
Serato DJ Pro.....	12
<b>PC/Mac setup</b> .....	<b>13</b>
Setting Utility .....	16
<b>Part names</b> .....	<b>19</b>
Top panel .....	19
Front panel.....	20
Rear panel.....	20
Touch screen .....	22
Jog display .....	29
<b>Connections (basic styles)</b> .....	<b>31</b>
PRO DJ LINK .....	31
<b>Connecting storage devices (USB)</b> .....	<b>33</b>
USB section .....	33
USB device .....	34
<b>Track selection</b> .....	<b>35</b>
Browse section.....	35
Selecting a source.....	36
Selecting a track.....	36

Sorting tracks .....	37
Searching for a track .....	38
Monitoring sound before loading a track (Touch Preview) .....	42
Loading a track to a deck .....	42
Using History .....	44
Using the Tag List .....	45
Displaying the playlist screen .....	49
<b>Playback .....</b>	<b>52</b>
Deck section .....	52
Play/pause .....	53
Playing a track from the touched point on the overall waveform .....	54
Reverse playback .....	54
Basic operations during playback .....	55
Adjusting the playback speed (tempo control) .....	55
Adjusting the playback speed without changing the pitch (Master Tempo) .....	56
<b>Recording .....</b>	<b>57</b>
Splitting a track during recording .....	57
<b>Using the jog wheel .....</b>	<b>58</b>
Jog wheel section .....	58
Setting the jog wheel mode .....	59
Jog wheel operations .....	59
Adjusting the 'weight' of the jog wheel .....	60
Adjusting the playback starting and stopping speeds (for Vinyl mode) .....	60
<b>Cueing .....</b>	<b>62</b>
Setting a cue point .....	62
Jumping to a cue point .....	62
Checking a cue point (Cue Point Sampler) .....	63
Saving a cue point .....	63
Calling up a saved cue point .....	63

Deleting a saved cue point.....	64
Setting Auto Cue .....	64
<b>Looping.....</b>	<b>65</b>
Setting a loop .....	65
Fine-adjusting loop points .....	66
Adjusting the length of a loop.....	66
Returning to a loop-in point to start loop playback (Retrigger).....	67
Using Active Loop .....	67
Canceling loop playback .....	67
Emergency Loop .....	68
Saving a loop .....	68
Calling up a saved loop.....	68
Deleting a saved loop.....	69
<b>Quantize (for deck) .....</b>	<b>70</b>
Using Quantize.....	70
<b>Slip .....</b>	<b>71</b>
Turning Slip mode on.....	72
<b>Beat Sync .....</b>	<b>73</b>
Using Beat Sync.....	73
Using Instant Doubles .....	74
<b>Beatgrid .....</b>	<b>75</b>
Adjusting the beatgrid .....	75
<b>Using the Performance Pads.....</b>	<b>76</b>
Performance Pad section.....	76
Hot Cue/Gate Cue.....	77
Beat Loop.....	81
Slip Loop .....	82
Release FX .....	83
Beat Jump/Loop Move .....	84

<b>Audio output</b> .....	<b>85</b>
Channel section/master section .....	85
Outputting sound .....	87
Adjusting the sound.....	88
Setting the faders .....	89
<b>Monitoring sound</b> .....	<b>90</b>
Headphones section .....	90
Monitoring with headphones .....	90
Booth section .....	91
Using a booth monitor .....	91
<b>Microphone</b> .....	<b>92</b>
MIC section .....	92
Using a microphone .....	93
<b>AUX</b> .....	<b>94</b>
AUX section .....	94
Using AUX.....	95
<b>Sound Color FX</b> .....	<b>96</b>
Sound Color FX section .....	96
Using Sound Color FX .....	97
Sound Color FX types and settings.....	98
<b>Beat FX</b> .....	<b>100</b>
Beat FX section.....	100
Using Beat FX.....	101
Setting BPM manually (Tap mode) .....	102
Using Quantize (for Beat FX) .....	103
Beat FX types and settings .....	104
Registering Beat FX to Beat FX Bank.....	109
<b>Using DJ software</b> .....	<b>110</b>
Controlling DJ software .....	110

<b>Settings</b> .....	<b>112</b>
Changing the settings .....	112
Utility settings .....	113
Changing the settings on the Shortcut screen .....	118
Setting items on the Shortcut screen .....	119
Calling up My Settings saved on a storage device (USB).....	121
<b>Specifications</b> .....	<b>122</b>
<b>Additional information</b> .....	<b>124</b>
Troubleshooting .....	124
LCD display .....	125
Trademarks and registered trademarks .....	126
Cautions on copyrights.....	127

---

---

# Before you start

---

---

## How to read this manual

- Thank you for choosing this Pioneer DJ product.  
Be sure to read this manual, the “Quick Start Guide” and the “Precautions for Use” which are also included with this product. These documents include important information that you should understand before using the unit.
- In this manual the names of buttons, knobs and terminals that appear on the product, and the names of buttons, menus etc. in the software on your PC/Mac or mobile device, are indicated within square brackets ([ ]). (e.g. **[File]**, **[CUE]** button)
- Please note that the software screens and their specifications, as well as the external appearance and specifications of the hardware, are subject to change without notice.
- Please note that depending on the operating system version, web browser settings, etc. operation may differ from the ways described in this manual.
- Please note that the language on the screens of the software described in this manual may differ from the language on your screen.

---

---

## What's in the box

- Power cord
- USB cable
- Warranty (for some regions)<sup>\*1</sup>
- Quick Start Guide
- Precautions for Use
- Software license notice

\*1 Only products in Europe.

Products in North America and Japan include warranty information in the “Precautions for Use”.

---

## User guides

### ❖ rekordbox Introduction, Instruction Manual

Refer to the “rekordbox Introduction” to find out how to set up rekordbox, and see the “Instruction Manual” to find out how to use rekordbox.

Visit the URL below to find these user guides.

[rekordbox.com/manual](https://rekordbox.com/manual)

### ❖ Serato DJ Pro software manual

Refer to the following Serato DJ site.

[serato.com/dj/pro/downloads](https://serato.com/dj/pro/downloads)



---

---

# Product overview

---

---

## System requirements

---

---

### Supported audio sources

This unit supports the following sources.

- USB device
- PC/Mac (page 13)

#### ❖ USB devices

Use USB devices that support the following specifications.

---

Folder hierarchy	Up to 8 levels (Files in the lower levels can't be played with the unit.)
Maximum number of folders	Unlimited (Up to 10,000 folders in a folder can be displayed.)
Maximum number of files	Unlimited (Up to 10,000 files in a folder can be displayed.)
File format	FAT16, FAT32, HFS+ (NTFS and exFAT aren't supported.)

---

- The unit can play audio files saved on USB mass storage class devices.
- It may take some time for the unit to read a device when it contains many folders and files.
- Some USB devices may not work properly with this unit.
- The unit doesn't support the following.
  - Optical disc devices such as external DVD/CD drives
  - USB hubs
- We accept no responsibility for loss of data from USB devices, or other direct or indirect problems resulting from connections to this unit.
- If excessive current passes through the USB port on the unit, the USB indicator blinks and the unit stops the power supply to the USB device and stops communication. To restore the unit to a normal condition, disconnect the USB device from the unit. Do not use the USB device with the unit again.

If you still can't restore the unit to a normal condition (i.e. if the unit doesn't communicate with a connected USB device), turn the unit off and on.

- If USB devices have multiple partitions, only the first partition can be used (or if there is a partition including rekordbox library, the partition is used instead).
- USB devices with a flash card reader may not work properly with this unit.

---

## Supported file formats

The unit supports audio files in the following formats.

Type	Extension	Format	Bit depth	Bit rate	Sampling frequency	Encoding
MP3	.mp3	MPEG-1 AUDIO LAYER-3		32 to 320 kbps		
AAC	.m4a, .aac, .mp4	MPEG-4 AAC LC MPEG-2 AAC LC	16bit	16 to 320 kbps	32 kHz, 44.1 kHz, 48 kHz	CBR, VBR
WAV	.wav	WAV				Uncompressed PCM
AIFF	.aif, .aiff	AIFF	16bit, 24bit	—	44.1 kHz, 48 kHz	
FLAC	.flac, .fla	FLAC				Lossless compression

- Some files can't be played with the unit even if they are in a supported format.

---

## Tag information

This unit can read tag information from ID3 tags (v1, v1.1, v2.2.0, v2.3.0, v2.4.0) and meta tags set in audio files.

---

## Artwork of audio files

You can add an artwork image in JPEG format (extensions: “jpg”, “jpeg”) to each audio file. Images larger than 800 x 800 pixels can’t be displayed on this unit.

---

## Display language

If you want to display characters (track names, etc.) in local codes other than Unicode, change the [LANGUAGE] setting (page 116).

---

---

## rekordbox

rekordbox is a complete DJ application you can use to manage your music and perform.

- You can use audio files managed in Export mode (the rekordbox music management function) with this unit.
- This unit is a Hardware Unlock device. So, if you connect a PC/Mac running rekordbox to the unit, you can use Performance mode (rekordbox DJ functions) for free.
- For information on functions supported by Hardware Unlock, visit the URL below.  
[rekordbox.com](http://rekordbox.com)
- The rekordbox software isn’t included with the unit. Download the software from the URL below.  
[rekordbox.com](http://rekordbox.com)
- For information on the latest system requirements, compatibility, and supported operating systems, visit the URL below.  
[rekordbox.com/system](http://rekordbox.com/system)
- Operation isn’t guaranteed on all PC/Mac models, even if the system requirements are met.
- Depending on power-saving settings and other conditions of your PC/Mac, the CPU and hard disk may not provide sufficient processing capabilities. For laptops in particular, make sure the PC/Mac is in the best condition to provide constant high-level performance when using rekordbox (for example by keeping the AC power connected).

---

## Using mobile devices

If you connect mobile devices running rekordbox for iOS to the unit, you can play audio files managed in rekordbox for iOS.

- For information on the connection with rekordbox for iOS, refer to the FAQ at the URL below.

[rekordbox.com/support/faq/connecting-to-dj-units/](https://rekordbox.com/support/faq/connecting-to-dj-units/)

- You can't use mobile devices running rekordbox for Android with the unit.

---

---

## PRO DJ LINK

PRO DJ LINK supports USB Export, which utilizes a storage device (USB device), as well as rekordbox Link Export, which utilizes a PC/Mac running rekordbox.

 Read more: PRO DJ LINK (page 31)

---

---

## Serato DJ Pro

Serato DJ Pro is DJ software from Serato.

The Serato DJ Pro software isn't included with the unit. Download the software from the URL below.

[serato.com](https://serato.com)

- For information on the latest system requirements, compatibility, and supported operating systems, visit the URL below.

[serato.com/dj/pro/downloads](https://serato.com/dj/pro/downloads)

- Operation isn't guaranteed on all PC/Mac models, even if the system requirements are met.
- Depending on power-saving settings and other conditions of your PC/Mac, the CPU and hard disk may not provide sufficient processing capabilities. For laptops in particular, make sure the PC/Mac is in the best condition to provide constant high-level performance when using Serato DJ Pro (for example by keeping the AC power connected).

---

---

# PC/Mac setup

To input your PC/Mac's audio to the unit, install the following software on your computer.

– Dedicated audio driver software:

Driver software used for inputting the PC/Mac audio to the unit.

If you install the audio driver software, Setting Utility will also be installed with the driver software (page 15).

– rekordbox (Mac/Windows) USB connection (Link Export) driver software:

Driver software used for connecting a PC/Mac running rekordbox to the unit via USB (Link Export)

For information on the installation, visit the URL below.

[pioneerdj.com/support/](http://pioneerdj.com/support/)

- For information on the latest system requirements, compatibility, and supported operating systems, visit the URL below.

[pioneerdj.com/support/](http://pioneerdj.com/support/)

- Operation isn't guaranteed on all PC/Mac models, even if the system requirements are met.
- Operation isn't guaranteed when multiple units are connected to a PC/Mac.
- If a PC/Mac without the audio driver software installed is connected to the unit, errors may occur on the PC/Mac.
- Malfunctions may occur due to incompatibility with other software installed on a PC/Mac.

---

## Installation of the dedicated audio driver software

### ❖ Notes on installation

- Turn the unit off and disconnect the USB cable connected to the unit and the PC/Mac before installation.
- Close all applications running on the PC/Mac before installation.
- You'll need admin rights to install the audio driver software to your PC (Windows).
- Read the License Agreement terms carefully before installation.
- If you quit the installation halfway through, perform the installation procedure from the beginning again.
- After the installation is complete, connect the PC/Mac to the unit.
- Operation isn't guaranteed on all PC/Mac models.

---

## Downloading the dedicated audio driver software

### 1 Visit the URL below.

[pioneerdj.com/support/](http://pioneerdj.com/support/)

### 2 Click [software & firmware updates].

### 3 Click [XDJ-RX3] under [ALL-IN-ONE DJ SYSTEM].

### 4 Click [Drivers].

### 5 Click [Download link] and save the file.

- Download the audio driver software dedicated to your PC/Mac.
- For Mac, the audio driver software varies depending on the version of macOS you're using.

---

## Installing the dedicated audio driver software

### 1 Unzip the downloaded audio driver software.

- Unzip “XDJRX3####.exe.zip” if you’re using a PC (Windows), or “XDJRX3M####.dmg.zip” if you’re using a Mac (# indicates the version number of the software).

### 2 Double-click the downloaded installation file.

- Double-click “XDJ-RX3\_#.###.exe” if you’re using a PC (Windows), or “XDJ-RX3\_M\_#.###.dmg” → “XDJ-RX3AudioDriver.pkg” if you’re using a Mac (# indicates the version number of the software).

### 3 Read the License Agreement terms carefully.

**If you agree to the terms, mark the [Agree] check box and click [OK].**

- If you don’t agree to the License Agreement terms, click [**Disagree**] (for Mac)/[**Cancel**] (for Windows) to cancel the installation.

### 4 Follow the on-screen instructions to complete the installation.

- If you’re using a Mac, visit the URL below and read “Important notice for installing the driver software on macOS”.

[pioneerdj.com/support/](http://pioneerdj.com/support/)

---

## Setting Utility

Once you've installed the driver software on your PC/Mac, you can use the Setting Utility for the following.

- Adjusting the buffer size (for Windows ASIO) (page 17)
- Checking the software versions (page 18)

---

## Launching Setting Utility

### ❖ For Mac

- 1 Open the [Applications] folder in Finder.
- 2 Click [Pioneer] → [XDJ-RX3] → [XDJ-RX3 Driver Version Display Utility].

### ❖ For PC (Windows)

- 1 Open the Start menu and click [Pioneer] → [XDJ-RX3 Setting Utility].



---

## Adjusting the buffer size (for Windows ASIO)

- Close any running applications (DJ applications, etc.) which use the unit as the default audio device before adjusting the buffer size.

➡ Read more: Launching Setting Utility (page 16)

**1 Click the [ASIO] tab.**

**2 Adjust the buffer size with the slider.**



- Breaks in sound are less likely to occur if you set a large buffer size, but this increases lag time due to the latency of audio data transmission.

## Checking the software versions

➤ Read more: Launching Setting Utility (page 16)

### 1 Click the [About] tab.



# Part names

## Top panel

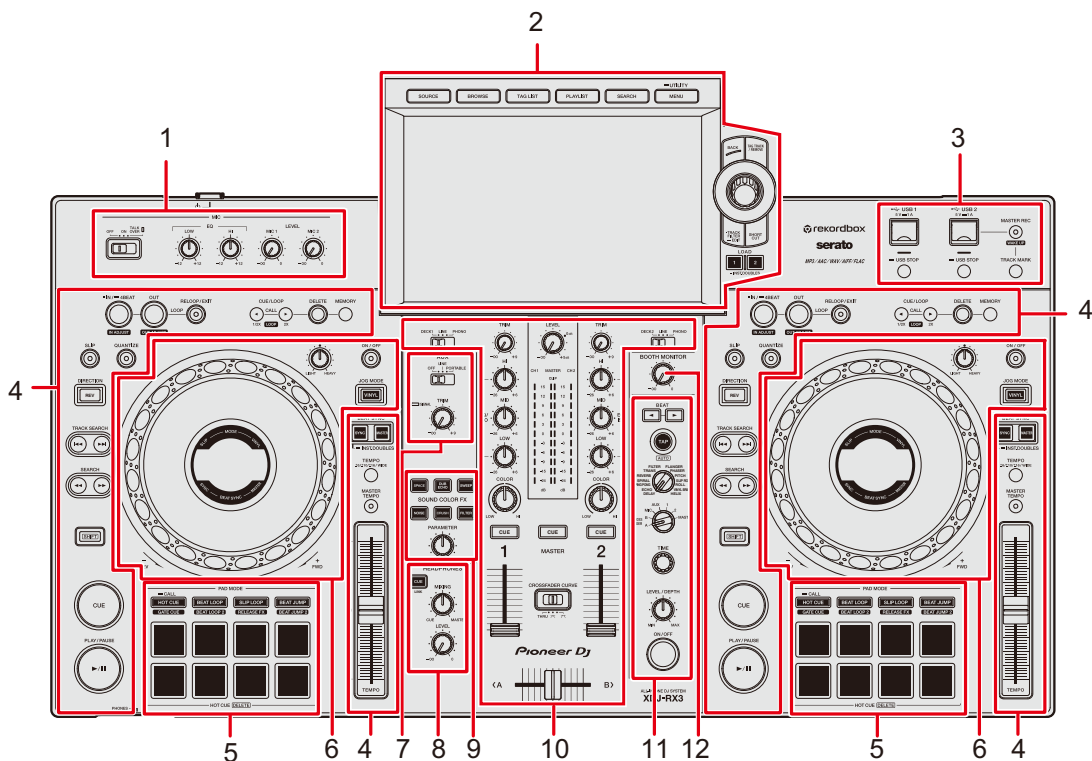

1. **MIC section** (page 92)
2. **Browse section, Touch screen** (pages 22, 35)
3. **USB section** (page 33)
4. **Deck section** (page 52)
5. **Performance Pad section** (page 76)
6. **Jog wheel section** (pages 29, 58)
7. **AUX section** (page 94)
8. **Headphones section** (page 90)
9. **Sound Color FX section** (page 96)
10. **Channel section/Master section** (page 85)
11. **Beat FX section** (page 100)
12. **Booth section** (page 91)

---

## Front panel

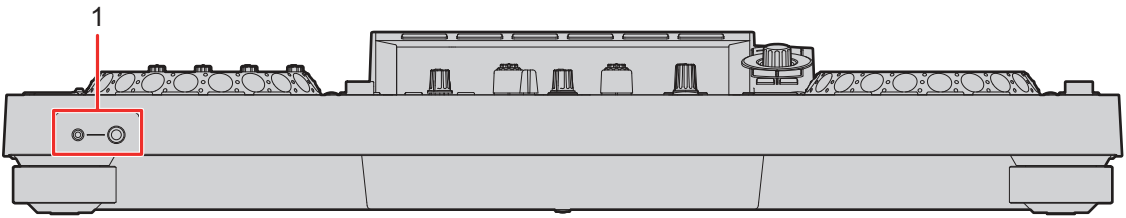

### 1. PHONES terminals (page 90)

Connect headphones to one of the terminals (1/4" stereo phone jack or 3.5 mm stereo mini-jack). Using both terminals at the same time may lower the sound quality or volume level.

---

## Rear panel

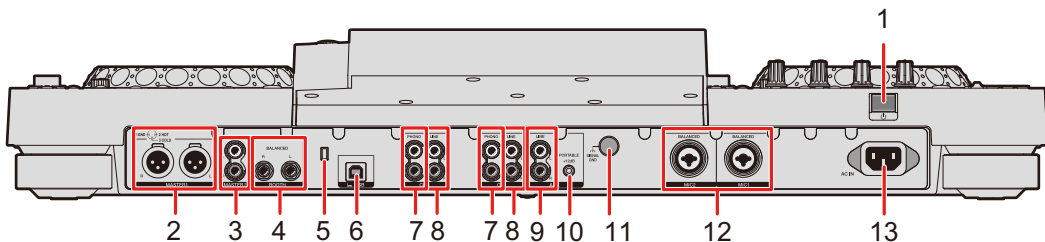

### 1. **⏻ button**

Turns the unit on or puts it in standby mode.

### 2. **MASTER 1 terminals (balanced XLR)**

Connect to analog input terminals on a power amplifier and powered speakers, etc.

- Use the terminals for balanced output only. Connecting the terminals to unbalanced inputs (RCA, etc.) with an XLR-RCA conversion cable (conversion adapter), etc. results in unwanted noises and/or poor sound quality.
- Do not connect a power cord from another product to the terminals.
- Do not connect to a terminal that can supply phantom power.
- Use the **[MASTER 2]** terminals for unbalanced input (RCA, etc.).

### 3. **MASTER 2 terminals (RCA)**

Connect to analog input terminals on a power amplifier, etc.

4. **BOOTH terminals (1/4"/6.35 mm, TRS)** (page 91)  
Connect a booth monitor.
  - Use the terminals for balanced output only. Connecting the terminals to unbalanced inputs results in unwanted noises and/or poor sound quality.
5. **Kensington security slot**  
Connect a cable lock.
6.  **USB port** (page 31)  
Connect a PC/Mac.
7. **PHONO terminals (RCA)**  
Connect phono-level (MM cartridge) output devices.
  - Do not input line-level signals to the terminals.
8. **LINE terminals (RCA)**  
Connect multi players or line-level output devices.
9. **AUX LINE terminals** (page 95)  
Connect line-level output devices.
10. **AUX PORTABLE terminal** (page 95)  
Connect an output device such as a mobile device.
11. **Signal GND terminal**  
Connect a turntable's ground wire.  
Reduces unwanted noises that occur when a turntable is connected to the unit.
12. **MIC 1, MIC 2 terminals (XLR or 1/4"/6.35 mm, TRS)** (page 93)
13. **AC IN**  
Connect to a power outlet with the supplied power cord.

## Touch screen

### SOURCE screen

Press the **[SOURCE]** button to display the source selection screen.

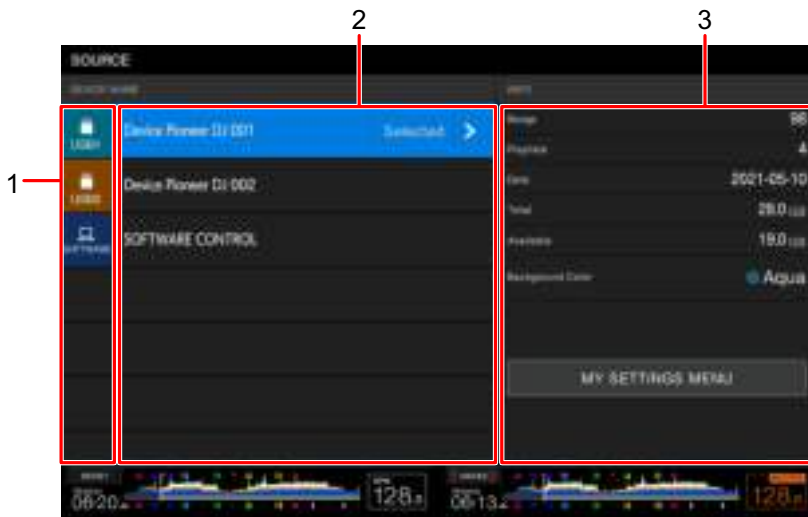

#### 1. Device icon

Displays the connected device.

- If **[BACKGROUND COLOR]** is set for the device, the icon's background is displayed in the chosen color.

#### 2. Device name

#### 3. Device information

Displays the information for the highlighted device in the list.

- You can set the following from **[MY SETTINGS MENU]** when a storage device (USB) is selected in the list.
  - **[LOAD]:** Calls up the Utility settings and some other settings saved on the storage device (USB). You can also call up My Settings from the **[SHORTCUT]** screen (page 121).
  - **[BACKGROUND COLOR]:** Sets the icon's background color (for storage devices (USB) containing audio files or management data exported from rekordbox). This setting is also applied to colors for a part of the touch screen.
  - **[WAVEFORM COLOR]:** Sets the color for the overall and detailed waveforms.

## Browse screen

Press the **[BROWSE]**, **[TAG LIST]**, **[PLAYLIST]**, or **[SEARCH]** button to display the browse screen (track list).

You can browse the rekordbox library on a storage device (USB) or on a connected PC/Mac.

- If you browse a storage device (USB) that doesn't contain a rekordbox library on the Browse screen, the folder and track lists are displayed in a hierarchical structure.

### When you press the **[BROWSE]** button



#### 1. **Category**

Displays the categories.

- Go to **[Preferences]** in rekordbox to choose the categories you want to display.

#### 2. **Device icon**

Displays the icon of a device selected on the **[SOURCE]** screen (page 22).

#### 3. **Next level up**

Displays the folder or device name in the next level up.

#### 4. **Track list**

Displays the preview waveform and artwork for each track, and the track list of the selected hierarchical level or playlist.

- If a rekordbox library isn't saved on the storage device (USB), the **[TRACK]** column is shifted to the left in the display area.
- Touch the waveform in the **[PREVIEW]** column to monitor the sound before loading a track (page 42).

## 5. **Countdown timer**

Displays the countdown timer.

The timer display turns from white to red when the remaining time becomes less than 5 minutes.

## 6. **Master Rec timer**

Displays the recording time when using Master Rec (page 57).

## 7. **INFO**

Touch to display or hide the detailed information for the track highlighted in the list (page 41).

## 8. **User setting categories**

- You can choose the categories to display here via rekordbox.
- If a rekordbox library isn't saved on the storage device (USB), the detailed information for the track highlighted in the list is displayed.

## 9. **Playback status display**

Displays the playback status for the loaded track.



## Playback screen (waveform screen)

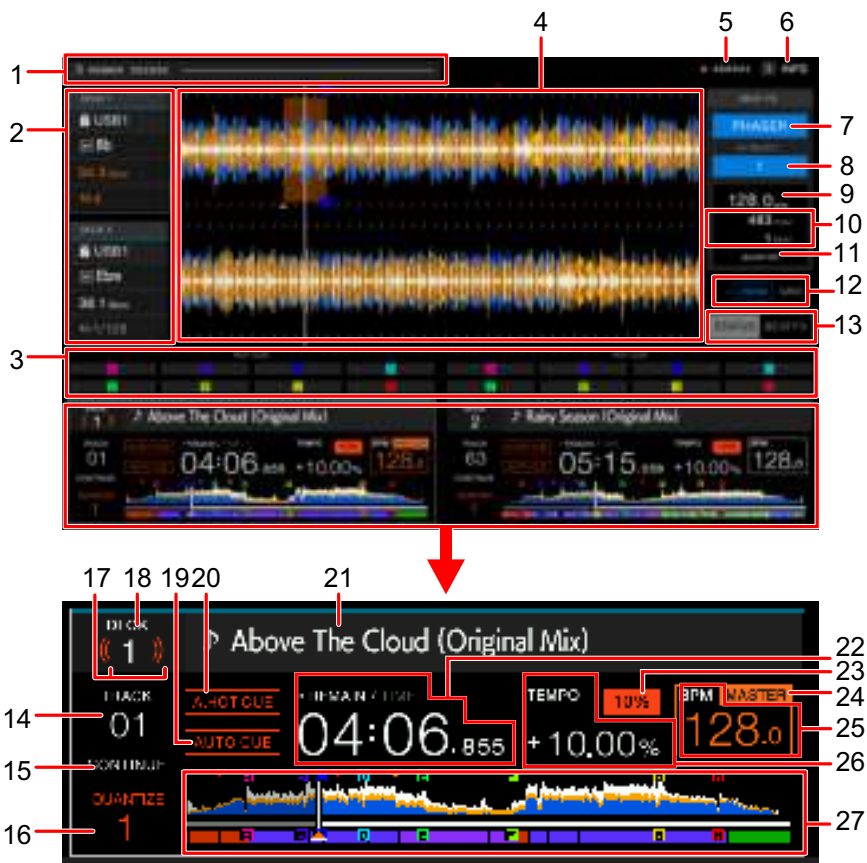

### 1. Countdown timer

Displays the countdown timer.

The timer display turns from white to red when the remaining time becomes less than 5 minutes.

Touch to display the timer settings screen. You can change the settings and start/stop the timer on the screen.

### 2. Deck information

Displays the following information for the loaded track.

- Device: Displays where the track is saved.
- Key: Displays the key of the track.
- Beat countdown: Displays the number of bars and beats from the playback point to the closest saved cue point.
- Loop icon/number of beats for loop: Lights up the loop icon while a loop is playing and displays the number of beats set for the loop.

- Touch **[DECK 1]** or **[DECK 2]** to switch the active deck.
- 3. Pad mode status/Beat FX controls**

Displays the pad mode being used on the deck, or Beat FX controls (Beat FX Bank and X-PAD).
  - 4. Enlarged waveform**

Displays the enlarged waveform, cue points, loop points, and Hot Cue points, etc. that have been analyzed by rekordbox.

    - You can change the waveform color in **[MY SETTINGS MENU]** on the **[SOURCE]** screen or **[WAVEFORM COLOR]** on the **[SHORTCUT]** screen (page 119).
  - 5. Master Rec timer**

Displays the recording time when using Master Rec (page 57).
  - 6. INFO**

Touch to display or hide the detailed information for the loaded track (page 41).
  - 7. Beat FX**

Displays the selected Beat FX (effect name) (page 101).
  - 8. Channel**

Displays the channel selected with the Beat FX channel selector switch (the channel the effect will be applied to).
  - 9. BPM (for Beat FX)**

Displays BPM (beats per minute, i.e. tempo).

    - In Auto mode, the automatically detected BPM is displayed.
    - In Manual Setting mode, the BPM is displayed in green and **[TAP]** is displayed.
  - 10. Parameter**

Displays the msec (milliseconds) and beat parameters set for the selected effect.
  - 11. QUANTIZE indicator (for Beat FX)**

Displayed in white when Quantize for Beat FX is turned on and active, and in gray when it's turned on but not active (page 103).
  - 12. Zoom/Grid Adjust mode indicator**

Press and hold the rotary selector or touch and hold **[ZOOM]/[GRID]** to switch between Zoom and Grid Adjust modes.

    - Turn the rotary selector to control the following.
      - In Zoom mode: Zooms in and out of the waveforms of DECK 1 and DECK 2 at the same time.
      - In Grid Adjust mode: Adjusts the beatgrid for the track loaded on the active deck (page 75).

## 13. **STATUS/BEAT FX indicator**

Touch [**STATUS**]/[**BEAT FX**] to switch between the pad mode status display and Beat FX controls.

- Touch [**BEAT FX**] to register Beat FX to Beat FX Bank, or use X-PAD (page 101).

## 14. **Track number**

Displays the number (01-999) of the loaded track.

## 15. **Play mode indicator**

Displays playback mode for the loaded track.

- Set the playback mode in [**PLAY MODE**] in the Utility settings (page 114).

## 16. **QUANTIZE indicator (for deck), number of beats for Quantize**

Displayed in red when Quantize for that deck is turned on and active, and in gray when it's turned on but not active.

- Set the number of beats in [**QUANTIZE BEAT VALUE**] in the Utility settings or on the [**SHORTCUT**] screen (pages 113, 119).

## 17. **On Air Display**

Displays red 'waves' when the sound from that deck is playing through the master output.

## 18. **Deck number**

## 19. **AUTO CUE indicator** (page 64)

Displayed when the Auto Cue is turned on.

## 20. **A. HOT CUE indicator**

Displayed when [**HOT CUE AUTO LOAD**] is turned on (page 79).

## 21. **Track name**

Displays name of the loaded track.

## 22. **Time display (minutes, seconds, msec)**

Displays remaining time or elapsed time.

Touch the time display to switch between remaining time and elapsed time.

Touch and hold the time display to turn Auto Cue on and off.

- [**TIME**] is shown in gray when remaining time is displayed, and [**REMAIN**] is shown in gray when elapsed time is displayed.
- You can also set the time display (remaining time or elapsed time) in [**TIME**] and turn Auto Cue on and off in [**AUTO CUE**] on the [**SHORTCUT**] screen (page 119).

## 23. **Playback speed adjustment range**

Displays the adjustable range from the original playback speed (page 55).

## 24. **MASTER indicator**

Displayed when the unit is set as the master deck.

## 25. **BPM (for Deck)**

Displays BPM (beats per minute, i.e. tempo) for the track playing.

- The measured value may differ from that measured by our DJ mixers due to differences in the measurement methods. This isn't a malfunction.

## 26. **Playback speed**

Displays the playback speed set by the **[TEMPO]** slider.

## 27. **Overall waveform**

Displays the overall waveform, cue points, loop points, and Hot Cue points, etc. that have been analyzed by rekordbox.

You can start playback from a point you touch on the waveform (page 54).

- The indicators on the overall waveform indicate the following.
  - **Playing address:** Shows the track as a bar graph (horizontal line). The current playback point is indicated with a white vertical line on the bar graph. When the time display is set to **[TIME]**, the graph lights up from the start of the track up to the playback point to indicate elapsed time. When the time display is set to **[REMAIN]**, the graph goes dark to the left of the playback point, so the remaining part of the track stays lit up. The graph blinks when the remaining time becomes less than 30 seconds, and blinks quicker when it becomes less than 15 seconds.
  - **Scale display (30-second interval)/phrase meter:** Displays scales at 30-second intervals or displays the phrase meter below the playing address. You can set the display (scale or phrase meter) in **[WAVEFORM DIVISIONS]** of the Utility settings (page 114).
  - **Saved cue points/saved loop points/saved Hot Cue points:** Indicates cue points, loop points, and Hot Cue points saved in the track with marks above the waveform.
  - **Cue points/loop points/Hot cue points:** Indicates cue points, loop points, and Hot Cue points set in the track with marks below the waveform.
- You can change the waveform color in **[WAVEFORM COLOR]** on the **[SHORTCUT]** screen (page 119).
- You can set different colors for cue points and Hot Cue points in rekordbox.

## Jog display

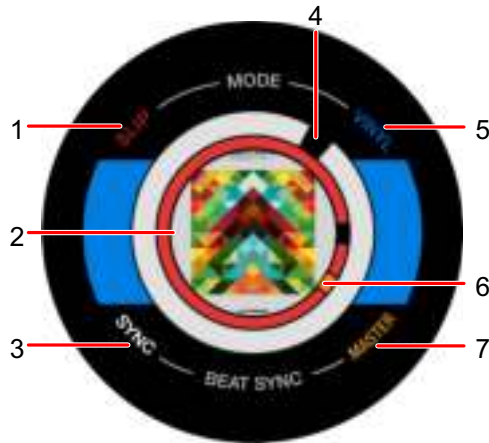

### 1. **SLIP indicator**

Lights up when Slip mode is turned on.

### 2. **Artwork/number of beats for loop/number of beats for Beat Jump**

Displays artwork of the loaded track.

Displays the number of beats for the loop when a loop is playing.

Displays the jump direction and the number of beats for 1 second when the playback point is moved (Beat Jump).

- You can set the artwork to display for each track in **[IMAGE ON JOG DISPLAY]** in the Utility settings (page 115).

### 3. **SYNC indicator**

Lights up when Beat Sync is turned on.

### 4. **Playback point indicator**

Indicates the playback point (turns during playback and stops when the track is paused).

### 5. **VINYL indicator**

Lights up when Vinyl mode is turned on.

### 6. **Cue/loop/Hot Cue point indicator**

Indicates cue points, loop points, or Hot Cue points.

### 7. **MASTER indicator**

Lights up when the deck is set as the sync master.

---

## Basic operations on the touch screen

Use the rotary selector or touch the screen to operate it.

### ❖ Using the rotary selector

**1 Turn the rotary selector to move the cursor and highlight an item.**

**2 Press the rotary selector to confirm your selection.**

- If you press the rotary selector when a hierarchical level is highlighted, the lower level is displayed.
- If you press the rotary selector when a menu item is highlighted, the selection is confirmed.

### ❖ Touch operations

**1 Touch the desired item to select it.**

- If you touch a hierarchical level, the lower level is displayed.
- If you touch a track, [LOAD] is displayed. Touch [LOAD] to load the track and display the waveform screen.

### ❖ Returning to the next level up

**1 Press the [BACK] button on the top panel.**

The next level up (previous screen) is displayed.

- Press and hold the [BACK] button to highlight the top level in the hierarchy.

---

---

# Connections (basic styles)

Turn the unit off and disconnect the power cord before connecting other units.

Connect the power cord after all the connections are complete.

- Use the supplied power cord.
- For the best performance, connect the unit directly to your PC/Mac with the supplied power cord.
- Read the instruction manuals for the devices you are going to connect with the unit.

---

---

## PRO DJ LINK

---

### USB Export

You can transfer audio files and management data of rekordbox for use on this unit using a storage device (USB). You can play tracks with cues, loops, and Hot Cues previously set in rekordbox.

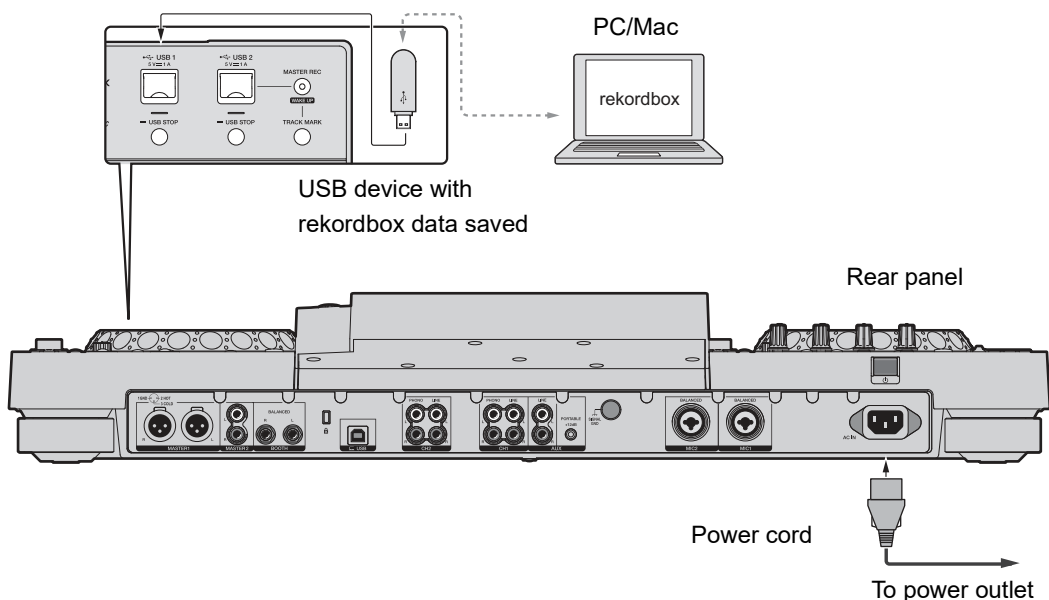

---

## rekordbox Link Export

You can directly select and play tracks in rekordbox with this unit when the unit is connected via a USB cable to a PC/Mac running rekordbox. You can play tracks with cues, loops, and Hot Cues previously set in rekordbox.

- Install the rekordbox (Mac/Windows) USB connection (Link Export) driver software before connecting the unit to a PC/Mac with a USB cable (page 13).
- For information on the connection with rekordbox for iOS, refer to the FAQ at the URL below.

[rekordbox.com/support/faq/connecting-to-dj-units/](http://rekordbox.com/support/faq/connecting-to-dj-units/)

- You can't use mobile devices running rekordbox for Android with the unit.

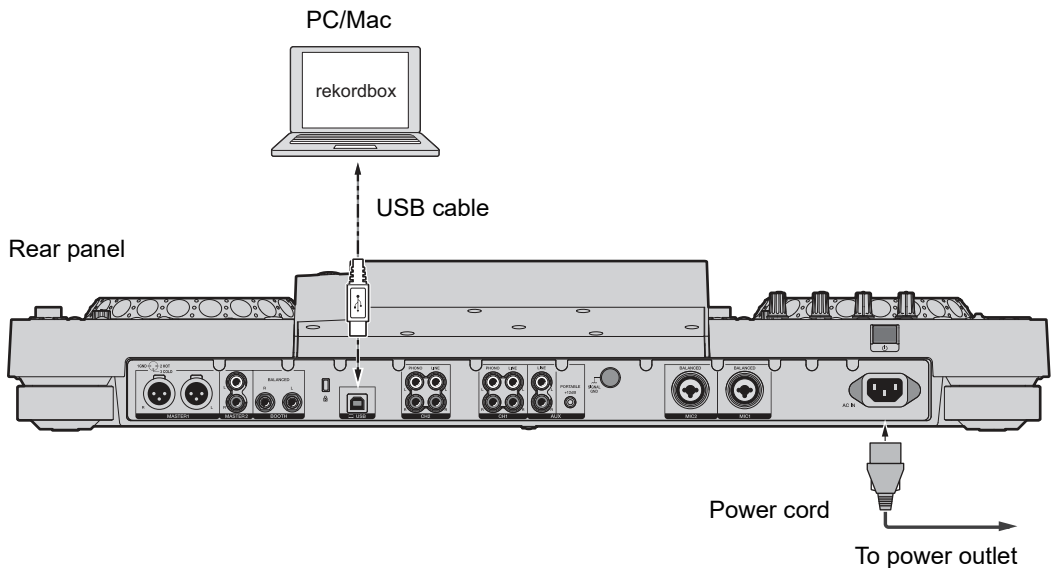

- Insert or pull a USB cable straight into/out of the USB port on the rear panel. Be careful not to apply force in a vertical or horizontal direction.



---

---

# Connecting storage devices (USB)

---

---

## USB section

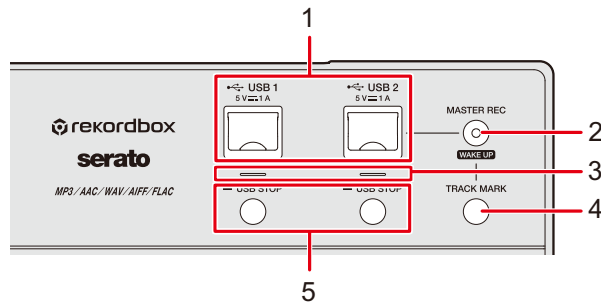

1. **USB 1, USB 2 ports**
2. **MASTER REC (WAKE UP) button** (page 57)
3. **USB 1, USB 2 indicators**  
Each indicator blinks when the unit is communicating with a USB device connected to the corresponding port.
4. **TRACK MARK button** (page 57)
5. **USB 1, USB 2 STOP buttons**

## USB device

- Do not disconnect a USB device from the unit or turn the unit off while the USB device indicator is blinking. The unit's management data may be deleted or the USB device may become unreadable.
- Be careful not to press or pull the USB port cover with excessive force, or it may be damaged.

---

## Connecting a USB device

- 1 Open the USB port cover.
- 2 Insert a USB device at a straight angle until it stops.

---

## Disconnecting a USB device

- 1 Press and hold the [USB STOP] button until the USB indicator stops blinking.
- 2 Pull the USB device out at a straight angle.
- 3 Close the USB port cover.

---

---

# Track selection

---

---

## Browse section

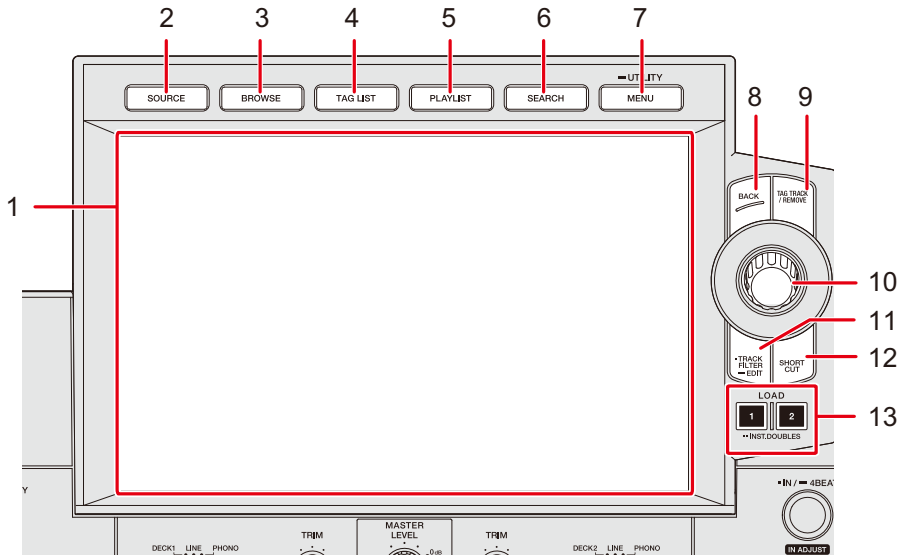

1. **Touch screen** (page 22)
2. **SOURCE button**  
Displays the [SOURCE] screen.
3. **BROWSE button**  
Displays the Browse screen.
4. **TAG LIST button**  
Displays the Tag List screen.
5. **PLAYLIST button**  
Displays the Playlist screen.
6. **SEARCH button**  
Displays the Search screen.
7. **MENU/UTILITY button**  
Displays menu items for the current screen (the function being used) or the Utility settings (page 112).
8. **BACK button** (page 30)

## 9. TAG TRACK/REMOVE button

Adds tracks to, or deletes them from, the tag list (page 45).

## 10. Rotary selector

## 11. TRACK FILTER/EDIT button

Narrows down tracks by tag information, BPM, or key, etc. set in rekordbox (page 40).

## 12. SHORTCUT button (page 119)

## 13. LOAD 1, LOAD 2 buttons

---

---

## Selecting a source

### 1 Press the [SOURCE] button.

Devices connected to the unit are displayed on the [SOURCE] screen.

➤ Read more: SOURCE screen (page 22)

### 2 Select a device.

---

---

## Selecting a track

---

### Selecting a track on the browse screen

### 1 Open the browse screen.

A track list is displayed.

➤ Read more: Browse screen (page 23)

### 2 Select a track.

➤ Read more: Loading a track to a deck (page 42)

---

## Sorting tracks

This feature is only available when browsing the rekordbox library.

### 1 Press the **[MENU/UTILITY]** button when a track list is displayed.

The sorting menu appears.

### 2 Select a sorting item.

- You can change sorting items displayed in the sorting menu via rekordbox. To reflect the changed setting to the rekordbox library saved on a storage device (USB), export it to the device again.
- The following sorting item is always displayed in the sorting menu.
  - **[BPM (UNSORTED)]**: Displays BPM-KEY in the default order in the user setting categories.

---

## Searching for a track

---

---

### Using the Search feature

This feature is only available when browsing the rekordbox library.

#### 1 Press the [SEARCH] button.

The Search screen appears.



#### 2 Enter a keyword using the keyboard.

Tracks including the keyword are displayed in the list.

- You can specify multiple keywords by separating them with a space.
- Select the search method from the following options in the menu.
  - **[AND]**: Displays tracks including the specified characters.
  - **[NARROW DOWN]**: Narrows down tracks by the specified track name.

---

## Using the Jump feature

The unit supports 2 jump modes.

### ❖ Alphabet Jump

#### 1 Press and hold the rotary selector when the alphabetical order list is displayed.

Alphabet Jump mode turns on, and the first character of the highlighted track or category is displayed on the screen.

- A to Z, 0 to 9, and some symbols are displayed in Alphabet Jump mode.

#### 2 Turn the rotary selector to scroll the screen.

The cursor jumps to the track or category whose first character is the same as the displayed character.

- The cursor doesn't jump when there are no tracks or categories whose first character is the same as the displayed character.

### ❖ Page Jump

#### 1 Press and hold the rotary selector when a list other than the alphabetical order list is displayed.

Page Jump mode turns on.

#### 2 Turn the rotary selector to scroll the screen.

The cursor jumps to the first track in the list on each page.

---

## Using Track Filter

You can narrow down tracks by BPM, key, or the tag information added by rekordbox, etc. This feature is only available when browsing the rekordbox library.

### ❖ Narrowing down tracks

#### 1 Press the [TRACK FILTER/EDIT] button.

Tracks are narrowed down by the currently set conditions.

### ❖ Specifying the conditions on the Track Filter editing screen

#### 1 Press and hold the [TRACK FILTER/EDIT] button.

The Track Filter editing screen appears.

#### 2 Specify the filter conditions.

- You can choose BPM, key, rating, color, or the tag information added by rekordbox as filter conditions.
- Touch to add a check mark to enable the filter conditions.
- Touch [MASTER DECK] to read the BPM and key of the track playing on the deck set as the sync master.
- You can set the track filter conditions in rekordbox.
- The filter conditions are saved independently for each storage device (USB).

---

## Searching by key of the track playing

Select the key category on the browse screen. The key icons of tracks which are good matches with the key (related key) of the track loaded to the master deck are displayed in green.

- This function isn't available when no deck is set as the sync master.



## Searching with Information Jump

You can search for tracks of the same genre or BPM as the track whose details are displayed on the touch screen.

### 1 Touch [INFO] on the waveform screen.

The information screen appears.

➤ Read more: Playback screen (waveform screen) (page 25)



1. **Deck information:** Touch [DECK 1] or [DECK 2] to switch the decks and display the information of the track loaded on the relevant deck.
2. **Detailed information of the track**
  - To change your rating of the track, select ☆☆☆, press and hold the rotary selector, and turn the rotary selector.
3. **Cover art/comment**

### 2 Select an item from the detailed information of the track.

Tracks included in the selected category are displayed on the browse screen.

- You may not be able to select items if any of the following conditions apply.
  - There are no categories.
  - Only icons are displayed in the detailed information of the track.
- If you select a track name, the browse screen displayed before loading the track will be displayed.

- If a rekordbox library isn't saved on the storage device (USB), you can only select a track – there's no option to select detailed information.

---

---

## Monitoring sound before loading a track (Touch Preview)

You can monitor the sound of a track before loading the track.

### 1 Connect headphones to the unit.

➤ Read more: Front panel (page 20)

### 2 Press the [CUE (LINK)] button.

➤ Read more: Headphones section (page 90)

### 3 Touch the waveform on the browse screen.

Monitor the sound from the touched point with your headphones.

- You can monitor the sound of a track even when outputting the sound of a track playing on the unit.
- You can't monitor the sound of tracks which can't be loaded to the decks and whose preview waveform can't be displayed.

➤ Read more: Browse screen (page 23)

---

---

## Loading a track to a deck

### 1 Select a track in the track list.

➤ Read more: Selecting a track (page 36)

### 2 Press the [LOAD 1] or [LOAD 2] button.

The track is loaded to the corresponding deck.

- You can't load another track while a track is playing when **[LOAD LOCK]** is set to **[LOCK]** in the Utility settings or on the **[SHORTCUT]** screen (pages 113, 119).  
Set it to **[UNLOCK]**, or press the **[PLAY/PAUSE ►/II]** button to pause playback, and then load another track.
- When Auto Cue is turned on, playback is paused at the start of a track. Press the **[PLAY/PAUSE ►/II]** button to start playback.

---

## Loading a track using the track menu

You can display the track menu by pressing the rotary selector when a track is selected on the Browse, Playlist, Search, or Tag List screen or when a comment on a saved cue/loop is selected.

You can then load a track from the track menu.

Track menu	Browse, Playlist, and Search screens	Tag List screen	When a comment on a saved cue/loop is selected
<b>CANCEL</b>	Closes the track menu.		
<b>LOAD TO DECK 1</b>	Loads a track to DECK 1 and starts playback.		Calls up the selected point to DECK 1.
<b>LOAD TO DECK 2</b>	Loads a track to DECK 2 and starts playback.		Calls up the selected point to DECK 2.
<b>CUE/LOOP LIST</b>	Displays the comment list for cues saved in rekordbox.	-	-

---

## Using History

Tracks played for approximately 1 minute are recorded in the History (playback list) (up to 999 tracks).

- A new History is automatically created on a storage device (USB) when it's connected to the unit.
- If you play a track more than once in succession, it may not be recorded in History.
- The information such as name of tracks recorded in History is displayed in green (indicates that the track has been played).
- You can create a playlist from the History using rekordbox. For details, refer to the rekordbox (Mac/Windows) user manual (page 8).

---

## Viewing History

### 1 Press the [BROWSE] button.

The Browse screen appears.

 Read more: Browse screen (page 23)

### 2 Select [HISTORY] in the category.

The History list is displayed.

---

## Deleting History

### 1 Select a History you want to delete in the History list and press the [MENU/UTILITY] button.

The deletion menu appears.

### 2 Select [DELETE] or [ALL DELETE].

— [DELETE]: Deletes the selected History.

— [ALL DELETE]: Deletes all History lists.

- If you create a playlist from the History using rekordbox, the HISTORY is deleted from the storage device (USB).

---

---

## Using the Tag List

You can tag a track you want to play next or tracks you think will work well in your performance and review them via the Tag List.

- One Tag List is created for each storage device (USB). A track can't be registered to multiple storage devices (USB).
- Up to 100 tracks can be registered to the Tag List on each storage device (USB).
- A track can't be registered to a Tag List more than once.

---

---

## Tag list screen



### 1. Preview waveform

Displays the Preview waveform. You can use Touch Preview when the Preview waveform is displayed (page 42).

### 2. Device icon

Displays the icon of a device selected on the [SOURCE] screen. You can change the background color via rekordbox.

### 3. Cover art

Displays the artwork set in rekordbox.

## 4. **Serial number**

## 5. **Tag list**

Displays the details of the tag list.

## 6. **Countdown timer**

Displays the countdown timer.

The time display turns from white to red when the remaining time becomes less than 5 minutes.

## 7. **Master Rec timer**

Displays the recording time when using Master Rec (page 57).

## 8. **INFO**

Touch to display or hide the detailed information for the track highlighted in the list.

## 9. **User setting categories**

You can choose the categories to display here via rekordbox.

If a rekordbox library isn't loaded on the storage device (USB), the detailed information of the highlighted track is displayed.

Turn the rotary selector to move the cursor up and down.

---

## Registering a track to the Tag List

### 1 **Highlight a track.**

- You can add tracks included in a folder or playlist to the Tag List instantly by selecting a folder or playlist.

### 2 **Press the [TAG TRACK/REMOVE] button.**

A check mark is displayed for the tracks registered to the Tag List.

- You can add the loaded track to the Tag List by pressing the [TAG TRACK/REMOVE] button on the waveform screen or information screen. “♪s” is displayed for tracks added while they are loaded.

If you load a track marked with “♪s” from the Tag List, it's loaded in the same status as when it was added. Cue points and loop points are also loaded.

- If you add tracks by selecting a folder, the file name is registered as the track name for any track whose ID3, etc. hasn't been read (the artist name won't be registered). When the track (added to the Tag List) is displayed on the browse screen or the ID3 etc. is read after the track is loaded, the file name changes to a track name and an artist name is also registered.

---

## Deleting a track from the Tag List

### ❖ Deleting an individual track on the Tag List screen

- 1 Highlight a track.
- 2 Press and hold the [TAG TRACK/REMOVE] button.

The track is deleted from the Tag List.

### ❖ Deleting an individual track on the Browse, Playlist or Search screen

- 1 Highlight a track.
- 2 Press the [TAG TRACK/REMOVE] button.

The track is deleted from the Tag List.

### ❖ Deleting an individual track on the waveform screen/ information screen

- 1 Press the [TAG TRACK/REMOVE] button when a track registered to the Tag List is loaded.

The track is deleted from the Tag List.

## ❖ Deleting all tracks at once

### 1 Press the [TAG LIST] button.

The Tag List screen appears.

### 2 Press the [MENU/UTILITY] button.

The List Menu is displayed.

### 3 Select [REMOVE ALL TRACKS] in [TAGLIST MENU].

All tracks in the Tag List are deleted.

- If you delete a track from the Tag List while playing, the track continues to play until the end. The next track won't play.

---

## Converting the Tag List to a playlist

A playlist converted from the Tag List is displayed in the [PLAYLIST] category.

- You can't convert the Tag List to a playlist if the rekordbox library isn't saved on the storage device (USB).
- If a mixture of tracks – some managed and some not managed by rekordbox – are registered in the Tag List, only the tracks managed by rekordbox are converted to a playlist.

### 1 Press the [TAG LIST] button.

The Tag List screen appears.

### 2 Press the [MENU/UTILITY] button.

The List Menu is displayed.

### 3 Select [CREATE PLAYLIST] in [TAGLIST MENU].

The Tag List is converted to a playlist with the name [TAG LIST XXX].



## Displaying the playlist screen

### Playlist screen

Press the **[PLAYLIST]** button to display the **[PLAYLIST]** screen. You can also display the **[PLAYLIST]** screen from the browse screen (page 23).



#### 1. **Playlist Bank**

Displays the playlist when a playlist is registered to a Playlist Bank (page 51). With Playlist Banks, you can find a playlist without browsing the folder hierarchy.

#### 2. **Category**

Displays the playlist category.

#### 3. **Device icon**

Displays the icon of a device selected on the **[SOURCE]** screen. You can change the background color via rekordbox.

#### 4. **Next level up display**

#### 5. **Preview waveform**

Displays the Preview waveform. You can use Touch Preview when the Preview waveform is displayed (page 42).

#### 6. **Cover art**

Displays the artwork set in rekordbox.

#### 7. **Serial number**

## 8. **Track list**

Displays playlists or tracks in a playlist.

## 9. **Countdown timer**

Displays the countdown timer.

The time display turns from white to red when the remaining time becomes less than 5 minutes.

## 10. **Master Rec timer**

Displays the recording time when using Master Rec (page 57).

## 11. **INFO**

Touch to display or hide the detailed information for the track highlighted in the list.

## 12. **User setting categories**

You can choose the categories to display here via rekordbox.

Turn the rotary selector to move the cursor up and down.

## ❖ **Changing the status of a track in a playlist to PLAYED or UNPLAYED**

### 1 **Press the [MENU/UTILITY] button when a track in a playlist is selected.**

The List Menu is displayed.

### 2 **Select [PLAYED] or [UNPLAYED].**

— **[PLAYED]**: Sets unplayed tracks to “played”. Tracks set to “played” are displayed in green and registered to the History.

You can't select **[PLAYED]** when a played track is selected.

— **[UNPLAYED]**: Sets played tracks to “unplayed”. Tracks set to “unplayed” are displayed in white and deleted from the History.

You can't select **[UNPLAYED]** when an unplayed track is selected.

## ❖ Deleting a playlist

### 1 Press the [MENU/UTILITY] button on the Playlist screen.

The deletion menu appears.

### 2 Select [DELETE] or [ALL DELETE].

- [DELETE]: Deletes the selected playlist.
- [ALL DELETE]: Deletes all playlists.

---

## Registering a playlist to a Playlist Bank

### 1 Highlight a playlist on the Playlist screen.

### 2 Select a Playlist Bank whose icon is displayed in gray.

The playlist is registered to the Playlist Bank and the icon turns white.

- You can't register a playlist to multiple Playlist Banks.
- Select a Playlist Bank with a white icon to display tracks in the registered playlist.

---

## Deregistering a playlist from a Playlist Bank

### 1 Select [DELETE].

Deregistration mode turns on and × is displayed alongside Playlist Bank icons.

### 2 Select the Playlist Bank to deregister the playlist from.

The playlist is deregistered and deregistration mode turns off.

# Playback

## Deck section

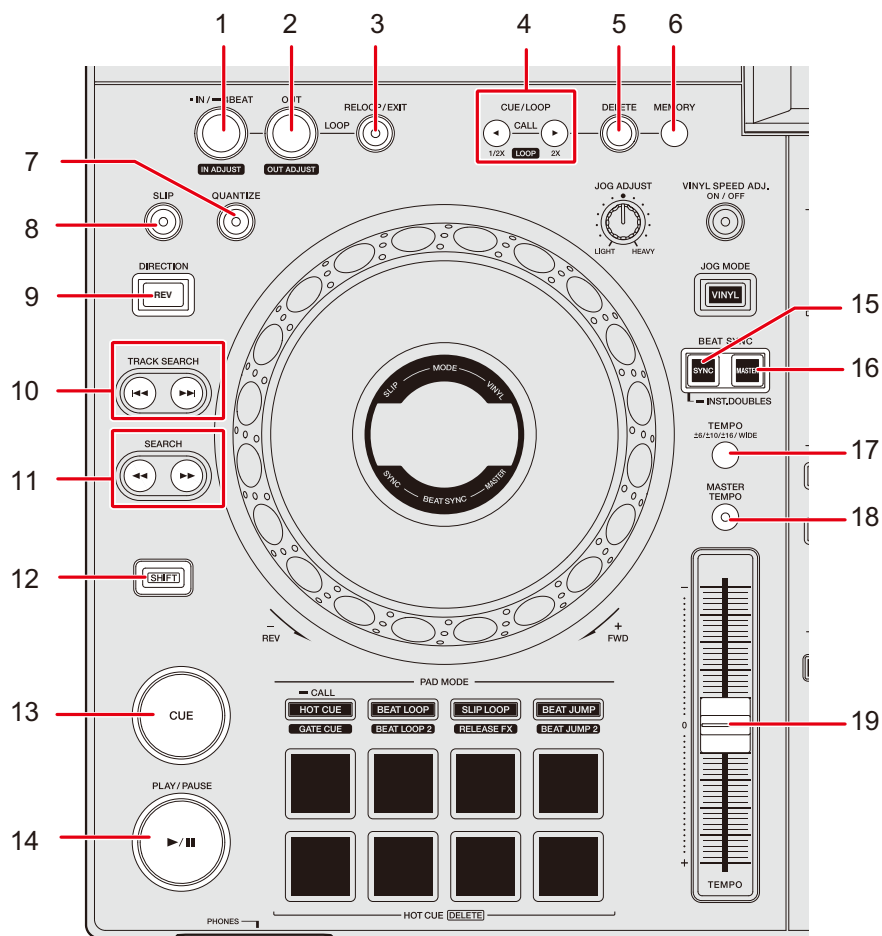

1. **LOOP IN/4 BEAT (IN ADJUST) button** (pages 62, 65)
2. **LOOP OUT (OUT ADJUST) button** (page 65)
3. **RELOOP/EXIT button** (pages 67, 81)
4. **CUE/LOOP CALL ◀ (LOOP 1/2X), ▶ (LOOP 2X) button** (pages 63, 66, 68)
5. **DELETE button** (pages 64, 69)
6. **MEMORY button** (pages 63, 68)
7. **QUANTIZE button** (page 70)
8. **SLIP button** (page 71)

9. **DIRECTION (REV) button**  
Lights up during reverse playback or Slip Reverse (page 71) .
10. **TRACK SEARCH |◀◀, ▶▶| button**  
Jumps to the beginning of a track.
11. **SEARCH ◀◀, ▶▶ button**  
Fast forward or fast reverse a track.
12. **SHIFT button**
13. **CUE button** (page 62)
14. **PLAY/PAUSE ▶/II button**  
Plays or pause a track.
15. **BEAT SYNC/INST.DOUBLES button** (pages 73, 74)
16. **MASTER button** (page 73)
17. **TEMPO ±6/±10/±16/WIDE button**  
Sets the variable range of the [TEMPO] slider.
18. **MASTER TEMPO button**  
Turns Master Tempo on and off.
19. **TEMPO slider** (page 55)

---

---

## Play/pause

### 1 Press the [PLAY/PAUSE ▶/II] button.

During pause: Starts playing the loaded track.

During playback: Pauses the track.

- Playback of the next track doesn't automatically start when [PLAY MODE] is set to [SINGLE] or [REPEAT] in the Utility settings (page 114).
- Pausing playback in Vinyl mode mutes the sound, and in Normal mode will output the sound intermittently (page 59).

---

---

## Playing a track from the touched point on the overall waveform

### 1 Touch the overall waveform.

The loaded track plays from the touched point.

- When **[NEEDLE LOCK]** is set to **[LOCK]** in the Utility settings (page 113), playback starts from the touched point only when you touch the overall waveform during pause or while touching the top of the jog wheel in Vinyl mode.
- You can quickly move the playback point by sliding your finger to the point you want on the overall waveform.

---

---

## Reverse playback

### 1 Press the **[DIRECTION (REV)]** button.

The loaded track plays in reverse.

- Acceleration and deceleration of playback according to jog wheel rotation are also reversed.
- Maintaining reverse playback from one track to the next isn't possible.
- You may not be able to scratch if you perform Track Search or loop playback during reverse playback.

## Basic operations during playback

Function	Description
Fast-forward/fast-reverse	<p>Press the [<b>SEARCH ►►</b>] or [<b>SEARCH ◀◀</b>] button to fast-forward or fast-reverse.</p> <ul style="list-style-type: none"> <li>Fast-forward or fast-reverse from one track to the next isn't possible when [<b>PLAY MODE</b>] is set to [<b>SINGLE</b>] or [<b>REPEAT</b>] in the Utility settings (page 114).</li> </ul>
Track Search	<p>Press the [<b>TRACK SEARCH ►►</b>] button to jump to the beginning of the next track.</p> <p>Press the [<b>TRACK SEARCH ◀◀</b>] button to jump to the beginning of the track that's playing. Press the button twice to jump to the beginning of the previous track.</p>
Frame Search	<p>Press the [<b>SEARCH ►►</b>] or [<b>SEARCH ◀◀</b>] button during pause to move the pause position.</p>

## Adjusting the playback speed (tempo control)

### 1 Move the [**TEMPO**] slider.

To the [+ ] side: Increases the playback speed.

To the [- ] side: Decreases the playback speed.

- The variable range of the [**TEMPO**] slider changes in the order of  $\pm 6$  (0.02%)  $\rightarrow$   $\pm 10$  (0.05%)  $\rightarrow$   $\pm 16$  (0.05%)  $\rightarrow$  WIDE (0.5%) each time you press the [**TEMPO  $\pm 6/\pm 10/\pm 16/\text{WIDE}$** ] button\*.

The adjustable range of [**WIDE**] is  $\pm 100\%$ . The track stops when it's set to -100%.

\* The value in parentheses indicates the adjustment unit.

---

## Adjusting the playback speed without changing the pitch (Master Tempo)

If you turn Master Tempo on, you can change the playback speed of a track using the [TEMPO] slider without changing the pitch.

### 1 Press the [MASTER TEMPO] button to turn Master Tempo on.

The button lights up when Master Tempo is turned on.

- Press the [MASTER TEMPO] button again to turn off Master Tempo.



---

---

# Recording

You can record the same audio as the output from the **[MASTER 1]** and **[MASTER 2]** terminals into a WAV file on a storage device (USB).

- The recorded file name will be “REC\*\*\*.WAV” (\*\*\*) is a 3-digit number).
- Because this unit doesn’t have a clock, the recording time and date aren’t registered on the storage device (USB).

## 1 Insert a USB device to the USB 2 port.

 Read more: USB section (page 33)

## 2 Press the **[MASTER REC (WAKE UP)]** button.

Recording starts and the **[MASTER REC (WAKE UP)]** button blinks.

- You can record for approximately 90 minutes on a storage device (USB) with 1GB of free space.
- Press the **[MASTER REC (WAKE UP)]** button again to end recording. Recording stops and the button light turns off.

---

---

# Splitting a track during recording

## 1 Press the **[TRACK MARK]** button during recording.

The file is split at the point where the **[TRACK MARK]** button is pressed, and the recording continues as a new file from the split point.

 Read more: USB section (page 33)

---

---

# Using the jog wheel

---

---

## Jog wheel section

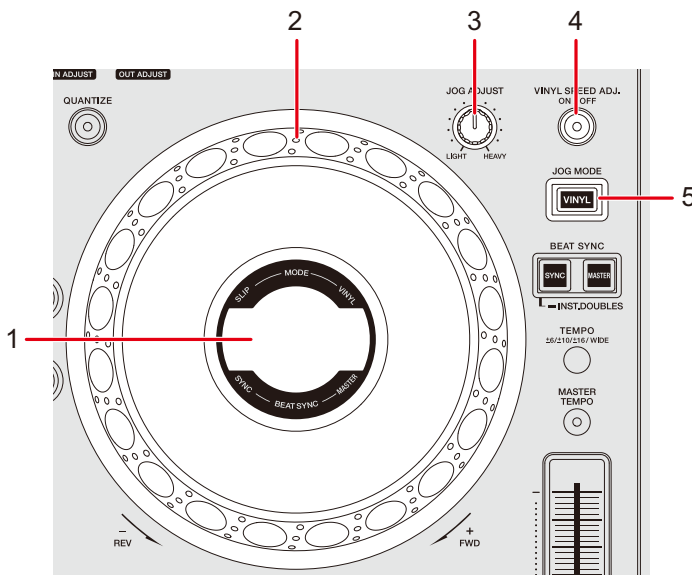

1. **Jog display** (page 29)
2. **Jog wheel (-REV/+FWD)**
  - A sensor is built into the top of the jog wheel. Do not place anything on it or apply strong force.
3. **JOG ADJUST knob**

Adjusts the 'weight' of the jog wheel.
4. **VINYL SPEED ADJ. ON/OFF button**

Turns on and off the speed adjustment function for playback/stop in Vinyl mode.
5. **JOG MODE (VINYL) button**

Sets the jog wheel mode.

---



---

## Setting the jog wheel mode

### 1 Press the [JOG MODE (VINYL)] button.

Each press switches between the following modes. The button lights up in Vinyl mode.

- **Vinyl mode:** Stops playback with a touch on the top (metal part) of the jog wheel and scratches a track by turning the jog wheel while touching the top.
- **Normal mode:** Doesn't stop playback or scratch a track with the operations of the jog wheel.

---



---

## Jog wheel operations

You can use the following features in combination with the jog wheel.

Function	Description
Pitch Bend	<p>Turn the outer section of the jog wheel clockwise during playback to increase the playback speed, and counterclockwise to decrease it. Stop turning it to resume the normal playback speed.</p> <ul style="list-style-type: none"> <li>• In normal mode, you can perform the same operations by turning the jog wheel while touching the top.</li> </ul>
Scratch	<p>Turn the jog wheel while touching the top (metal part) during playback in Vinyl mode to scratch a track.</p> <p>Release the jog wheel to resume normal playback.</p>
Frame Search	<p>Turn the jog wheel during pause to move the pause position.</p> <ul style="list-style-type: none"> <li>• One full rotation moves the position by 1.8 seconds.</li> </ul>
Super Fast Search	<p>Turn the jog wheel while pressing the [<b>SEARCH ►►</b>] or [<b>SEARCH ◄◄</b>] button to fast-forward or fast-reverse with extra speed.</p>
Super Fast Track Search	<p>Turn the jog wheel while pressing the [<b>TRACK SEARCH ◄◄</b>] or [<b>TRACK SEARCH ►►</b>] button to cycle through tracks with extra speed according to the rotation direction.</p>

---

---

## Adjusting the ‘weight’ of the jog wheel

### 1 Turn the [JOG ADJUST] knob.

Turn clockwise: Increases the weight.

Turn counterclockwise: Decreases the weight.

---

---

## Adjusting the playback starting and stopping speeds (for Vinyl mode)

You can adjust the following speeds.

- The speed at which playback slows down and stops after the top of the jog wheel is touched or the [PLAY/PAUSE ►/||] button is pressed
- The speed at which normal playback resumes after the top of the jog wheel is released or the [PLAY/PAUSE ►/||] button is pressed

### 1 Press and hold the [MENU/UTILITY] button.

The [UTILITY] screen appears.

### 2 Select an adjustment setting in [VINYL SPEED ADJUST].

- [TOUCH&RELEASE]: Adjusts the speed at which playback slows down and stops, and normal playback resumes.
- [TOUCH]: Adjusts the speed at which playback slows down and stops.
- [RELEASE]: Adjusts the speed at which normal playback resumes.

### 3 Press the [SHORTCUT] button.

The [SHORTCUT] screen appears.

### 4 Touch [<] or [>] in [VINYL SPEED ADJUST] to adjust the speed.

- [<]: Increases the speed.
- [>]: Decreases the speed.

- 5 Touch [ON] in [VINYL SPEED ADJUST], or press the [VINYL SPEED ADJ. ON/OFF] button on the deck.

The [VINYL SPEED ADJUST] setting on the [SHORTCUT] screen is enabled.

---

---

# Cueing

You can quickly call up a cue point you have set previously.

---

---

## Setting a cue point

### ❖ During pause

#### 1 Press the [CUE] button.

A cue point is set.

- Press the [SEARCH ◀◀] or [SEARCH ▶▶] button or turn the jog wheel during pause to fine-adjust (0.5 frame unit) the pause position.

### ❖ During playback

#### 1 Press the [LOOP IN/4 BEAT (IN ADJUST)] button.

A cue point is set.

- If you set a new cue point, the previously set cue point is cleared.

---

---

## Jumping to a cue point

#### 1 Press the [CUE] button during playback.

The track jumps to the cue point and playback is paused.

---

---

## Checking a cue point (Cue Point Sampler)

### 1 Jump to a cue point.

➡ Read more: Jumping to a cue point (page 62)

### 2 Press and hold the [CUE] button.

Playback continues until you release the [CUE] button.

- Press the [PLAY/PAUSE ►/||] button to continue playback even if you release the [CUE] button.

---

---

## Saving a cue point

### 1 Set a cue point.

➡ Read more: Setting a cue point (page 62)

### 2 Press the [MEMORY] button.

---

---

## Calling up a saved cue point

### 1 Load a track you have previously saved a cue point for.

### 2 Press the [CUE/LOOP CALL ◀ (LOOP 1/2X)] or [CUE/LOOP CALL ▶ (LOOP 2X)] button.

- If a comment is set to the called up point in rekordbox, the comment is displayed in the track name display. You can also check comments from the comment list displayed by pressing the rotary selector when a track list is displayed (page 43).  
You can call up a saved cue point by selecting a comment in the comment list and then pressing the [LOAD 1] or [LOAD 2] button.

---

---

## Deleting a saved cue point

### 1 Call up a saved cue point.

➡ Read more: Calling up a saved cue point (page 63)

### 2 Press the [DELETE] button.

---

---

## Setting Auto Cue

When loading a track or performing Track Search, a cue point can be automatically set to the position immediately before the first sound in the track (skipping any silence at the beginning).

### 1 Press the [SHORTCUT] button.

The [SHORTCUT] screen appears.

➡ Read more: Changing the settings on the Shortcut screen (page 118)

### 2 Touch [ON] in [AUTO CUE].

[AUTO CUE] is displayed on the waveform screen when Auto Cue is turned on.

- You can also turn Auto Cue on and off by touching and holding the time display on the waveform screen.
- The Auto Cue setting is retained even if you turn the unit off.
- You can set the sound pressure level that you want to be recognized as silence in [AUTO CUE LEVEL] in the Utility settings (page 113).



---

---

# Looping

You can choose a section of a track to play repeatedly.

---

---

## Setting a loop

---

---

### Manual setting

- 1 While the track is playing, press the **[LOOP IN/4 BEAT (IN ADJUST)]** button at the point where you want to start the loop (loop-in point).
- 2 Press the **[LOOP OUT (OUT ADJUST)]** button at the point where you want the loop to end (loop-out point).

The chosen section plays in a loop.

---

---

### Automatic setting

#### ❖ Using 4 Beat Loop

- 1 Press and hold the **[LOOP IN/4 BEAT (IN ADJUST)]** button during playback.

The track plays a 4-Beat Loop according to the BPM from the point where you pressed the button.

- If BPM can't be detected, it's set to 120.

---



---

## Fine-adjusting loop points

- 1 Press the **[LOOP IN/4 BEAT (IN ADJUST)]** or **[LOOP OUT (OUT ADJUST)]** button during loop playback.

The unit switches to loop adjusting mode.

- **[LOOP IN/4 BEST (IN ADJUST)]**: Adjusts the loop-in point.
- **[LOOP OUT (OUT ADJUST)]**: Adjusts the loop-out point.

- 2 Press the **[SEARCH ◀◀]** or **[SEARCH ▶▶]** button or turn the jog wheel to fine-adjust the loop point.

- The adjustable range for the loop-in point is  $\pm 30$  frame unit.
- Press the **[LOOP IN/4 BEAT (IN ADJUST)]** or **[LOOP OUT (OUT ADJUST)]** button again, or leave the unit without operating the controls for more than 10 seconds to resume loop playback.

---



---

## Adjusting the length of a loop

---

### Halving the length of a loop

- 1 Press the **[CUE/LOOP CALL ◀ (LOOP 1/2X)]** button during loop playback.

The loop length is halved each time you press the button.

---

## Doubling a loop in length

- 1 Press the **[CUE/LOOP CALL ► (LOOP 2X)]** button during loop playback.

The loop length is doubled each time you press the button.

---

---

## Returning to a loop-in point to start loop playback (Retrigger)

- 1 Press the **[LOOP IN/4 BEAT (IN ADJUST)]** button while pressing the **[SHIFT]** button during loop playback.

The playback point returns to the loop-in point and starts loop playback from there.

---

---

## Using Active Loop

Set a saved loop as an Active Loop using rekordbox beforehand.

- 1 **Load a track that has an Active Loop set.**

After the playback point passes the set point, loop playback automatically starts.

---

---

## Canceling loop playback

- 1 Press the **[RELOOP/EXIT]** button during loop playback.

Loop playback is canceled.

- Press the **[RELOOP/EXIT]** button again to start loop playback from the loop-in point.

---

---

## Emergency Loop

The unit automatically plays a Beat Loop if it can't start playing the next track when the end of the current track is reached. This prevents situations where your performance is interrupted by silence.

- You can't DJ during Emergency Loop playback.
- Load a track to cancel the Emergency Loop.

---

---

## Saving a loop

### 1 Set loop points.

➤ Read more: Setting a loop (page 65)

### 2 Press the [MEMORY] button.

---

---

## Calling up a saved loop

### 1 Load a track you have previously saved a loop for.

### 2 Press the [CUE/LOOP CALL ◀ (LOOP 1/2X)] or [CUE/LOOP CALL ▶ (LOOP 2X)] button.

- If a comment is set to the called up point in rekordbox, the comment is displayed in the track name display. You can also check comments from the comment list displayed by pressing the rotary selector when a track list is displayed (page 43).  
You can call up a saved loop point by selecting a comment in the comment list and then pressing the [LOAD 1] or [LOAD 2] button.

---

## Deleting a saved loop

**1 Call up a saved loop.**

**2 Press the [DELETE] button.**

- If you delete a loop set as an Active Loop, the Active Loop is also deleted (page 67).

---

---

# Quantize (for deck)

Cue points, loop-in points, loop-out points, and Hot Cue points are automatically set to the closest beat position even if your timing is off the beat when you set them.

You can use Hot Cues, loop, reverse playback, and Slip without breaking the rhythm of the track you are playing.

- You can't use the Quantize feature with tracks that haven't been analyzed by rekordbox. For details on track analysis, see the rekordbox Instruction Manual (page 8).
- You can set **[QUANTIZE BEAT VALUE]** in the Utility settings or on the **[SHORTCUT]** screen (pages 113, 119).

---

---

## Using Quantize

### 1 Press the **[QUANTIZE]** button.

Quantize turns on, then **[QUANTIZE]** and the number of beats set for Quantize are displayed on the screen.

- Press the **[QUANTIZE]** button again to turn Quantize off.

---

---

# Slip

If you turn Slip mode on, normal playback continues in the background (but you can't hear it) when you perform the following operations.

When you end the operation, Slip is canceled and normal playback starts from the exact point the track would have reached by then. This means the original rhythm remains constant and your performance stays perfectly in time.

Function	Description
Slip Pause	If you press the <b>[PLAY/PAUSE ►/II]</b> button during playback in Vinyl mode (page 59), playback continues in the background during the pause.
Slip Scratch	If you scratch a track using the jog wheel while in Vinyl mode (page 59), normal playback continues in the background while you are scratching.
Slip Loop	If you start loop playback (page 65), normal playback continues in the background while the loop is playing.
Slip Reverse	If you press the <b>[DIRECTION (REV)]</b> button during playback, playback is reversed. Normal playback continues in the background during reverse playback. Reverse playback is automatically canceled after 8 beats from the point where the <b>[DIRECTION (REV)]</b> button is pressed and playback starts from the exact point the track would have reached by then.
Slip Hot Cue	If you press a Performance Pad with a Hot Cue set during playback, the playback point jumps to the Hot Cue point and playback continues until you release the button. Normal playback continues in the background during Hot Cue playback. Hot Cue playback is automatically canceled after 4 beats from the point where the Performance Pad is pressed and playback starts from the exact point the track would have reached by then.

---

## Turning Slip mode on

### 1 Press the [SLIP] button.

Slip mode turns on and the [SLIP] button lights up.

- The [SLIP] button blinks while Slip is in use.
- The current playback point in Slip mode is indicated by a yellow line on the overall and enlarged waveforms on the waveform screen.  
The background playback point is indicated by a white line on the overall waveform on the waveform screen.
- Press the [SLIP] button again or load a track to turn off Slip mode.



---

---

# Beat Sync

If you turn Beat Sync on, tempo (BPM) and beat position of tracks on DECK 1 and DECK 2 of the unit automatically synchronize.

- Beat Sync can't be used with tracks that haven't been analyzed by rekordbox.

---

---

## Using Beat Sync

### 1 Play a track analyzed by rekordbox on the deck (DECK 1 or DECK 2) you want to set as the sync master.

- The deck that first plays a track analyzed by rekordbox will be the sync master.
- You can set either deck as the sync master by pressing the **[MASTER]** button on the deck.

### 2 Play a track analyzed by rekordbox on the deck you want to sync with the sync master.

### 3 Press the **[BEAT SYNC/INST.DOUBLES]** button on the deck you want to sync with the sync master.

Beat Sync turns on.

- Press the **[BEAT SYNC/INST.DOUBLES]** button again to turn Beat Sync off. If the position of the **[TEMPO]** slider doesn't match the playback tempo (BPM), the Beat Sync tempo is maintained. To restore normal use of the **[TEMPO]** slider, load the track again or move the slider until the BPM matches the playback tempo. After this, you'll be able to use the **[TEMPO]** slider to adjust the tempo.

---

## Using Instant Doubles

You can duplicate a track loaded on DECK 1 or DECK 2 so it plays on the other deck from exactly the same point.

### **1 Press and hold the [BEAT SYNC/INST.DOUBLES] button on the deck where you want the duplicate track to start playing.**

- You can also start Instant Doubles by pressing the [LOAD] button ([LOAD 1] or [LOAD 2]) twice on the deck where you want the duplicate track to start playing.

---

---

# Beatgrid

You can adjust the beatgrid.

- You can't adjust the beatgrid for tracks that haven't been analyzed by rekordbox.

---

---

## Adjusting the beatgrid

### 1 Press and hold the rotary selector on the waveform screen, or touch and hold **[ZOOM]/[GRID]** on the screen.

Grid Adjust mode turns on.

### 2 Turn the rotary selector to adjust the beatgrid.

- You can also adjust the beatgrid using the following buttons on the screen.
  - **[SNAP GRID(CUE)]**: Moves the first beat position to a cue point.
  - **[SHIFT GRID]**: Applies the settings (Pitch Bend, etc.) adjusted during synchronization.
  - **[<1/2], [1/2>]**: Moves the beatgrid by 1/2 beat.
- Touch **[RESET]** to reset to the original beatgrid.
- To return to Zoom mode, press and hold the rotary selector on the waveform screen, or touch and hold **[ZOOM]/[GRID]** on the screen again.

---

---

# Using the Performance Pads

You can trigger various functions with the Performance Pads.

---

---

## Performance Pad section

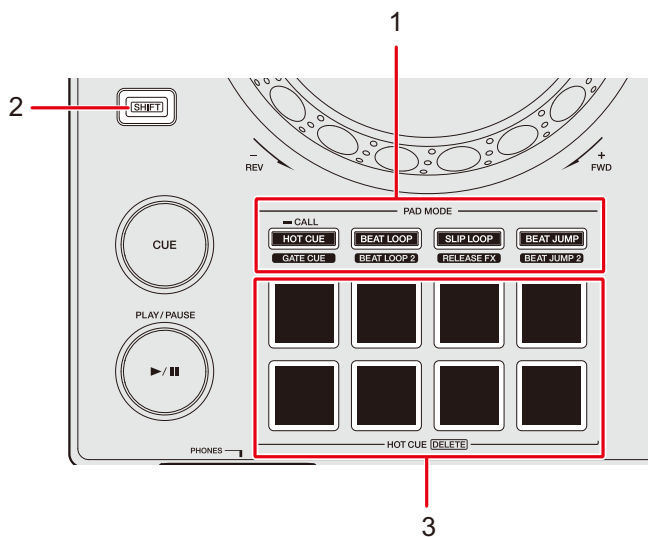

### 1. PAD MODE buttons

- **HOT CUE/CALL (GATE CUE) button:** Switches to Hot Cue mode or Gate Cue mode.
- **BEAT LOOP (BEAT LOOP 2) button:** Switches to Beat Loop mode.
- **SLIP LOOP (RELEASE FX) button:** Switches to Slip Loop mode or Release FX mode.
- **BEAT JUMP (BEAT JUMP 2) button:** Switches to Beat Jump mode.

### 2. SHIFT button

### 3. Performance Pads

---

---

## Hot Cue/Gate Cue

You can call up a Hot Cue quickly and start playback by pressing a Performance Pad.

---

### Setting a Hot Cue

#### 1 Press the [HOT CUE/CALL (GATE CUE)] button.

The unit switches to Hot Cue mode.

#### 2 Press a Performance Pad at the point where you want to set a Hot Cue during playback or pause.

A Hot Cue is set.

- You can set up to 8 Hot Cues per track.
- Hot Cues are assigned to the Performance Pads as follows.

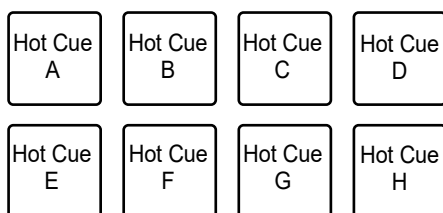

- If you do this during loop playback, a loop is set instead.
  - You can't set a Hot Cue to any Performance Pads that have a one set already. To set a new Hot Cue, delete a one from a button first (page 79).
- Performance Pads light up as follows according to the set function. You can change the colors using rekordbox.

Set function	[HOT CUE COLOR] setting in the Utility settings	
	[OFF]	[ON]
Cue point	Green	Fixed button color
Loop	Orange	Orange
No setting	No light	No light

## Starting playback from a Hot Cue point

### 1 Press the [HOT CUE/CALL (GATE CUE)] button.

The unit switches to Hot Cue mode.

### 2 Press one of the Performance Pads that have a Hot Cue set during playback or pause.

Playback starts from the Hot Cue point.

- If you do this when a loop is set, loop playback starts (page 65).

---

## Starting Gate playback from a Hot Cue point

### 1 Press the [HOT CUE/CALL (GATE CUE)] button in Hot Cue mode.

The unit switches to Gate Cue mode.

### 2 Press and hold one of the Performance Pads that have a Hot Cue set during pause.

Playback starts from the Hot Cue point and continues until you release the Performance Pad.

- If you do this when a loop is set, loop playback starts (page 65).
- Press the [PLAY/PAUSE ►/III] button during Gate playback to continue playback even if you release the Performance Pad.

## Deleting a Hot Cue

### 1 Press the **[HOT CUE/CALL (GATE CUE)]** button.

The unit switches to Hot Cue mode.

### 2 Press one of the Performance Pads while pressing the **[SHIFT]** button.

The Hot Cue set to the pad is deleted.

---

## Calling up Hot Cues

### ❖ Automatic call-up

You can automatically call up Hot Cues saved on a storage device (USB) when a track is loaded.

### 1 Press and hold the **[MENU/UTILITY]** button or press the **[SHORTCUT]** button.

The **[UTILITY]** or **[SHORTCUT]** screen appears.

### 2 Set **[HOT CUE AUTO LOAD]** to **[ON]** or **[rekordbox SETTING]**.

- **[ON]**: Displays “H” for all tracks and automatically calls up Hot Cues from all tracks when loading them. **[A. HOT CUE]** lights up in red on the screen.
- **[rekordbox SETTING]**: Automatically calls up Hot Cues from tracks with the “H” icon (indicates that the tracks have **[HOT CUE AUTO LOAD]** set using rekordbox) when loading them. **[A. HOT CUE]** lights up in white on the screen.
- **[OFF]**: Hot Cues aren't automatically called up when loading a track.

## ❖ Manual call-up

You can call up a Hot Cue manually when **[HOT CUE AUTO LOAD]** is set to **[OFF]** in the Utility settings or on the **[SHORTCUT]** screen, or when the conditions for the automatic call-up aren't met by **[rekordbox SETTING]**.

### 1 Press the **[HOT CUE/CALL (GATE CUE)]** button.

The unit switches to Hot Cue mode.

### 2 Press and hold the **[HOT CUE/CALL (GATE CUE)]** button.

Performance Pads that have a Hot Cue set will blink.

### 3 Press one of the blinking Performance Pads.

The set Hot Cue is called up.

- The Hot Cue call-up mode turns off in the following conditions.
  - All Hot Cues are called up.
  - The **[HOT CUE/CALL (GATE CUE)]** button is pressed.
  - The loaded track is replaced by another one.



---

## Beat Loop

If you press a Performance Pad, a loop is set with the number of beats or bars assigned to the Performance Pad.

---

### Using Beat Loop

#### 1 Press the [BEAT LOOP (BEAT LOOP 2)] button.

The unit switches to Beat Loop mode.

#### 2 Press a Performance Pad.

Loop playback starts according to the BPM of the track and the number of beats or bars assigned to the Performance Pad. The Performance Pad blinks during loop playback.

- The number of beats or bars for Beat Loop is assigned to the Performance Pads as follows. Press the [BEAT LOOP (BEAT LOOP 2)] button in Beat Loop mode to switch between Beat Loop mode and Beat Loop 2 mode.

Beat Loop mode:

1/4 beat	1/2 beat	1 beat	2 beats
4 beats	8 beats	16 beats	32 beats

- Beat Loop 2 mode:

3/4 beat	1 beat	3/2 beat	3 beats
5 beats	6 beats	7 beats	9 beats

- Press the blinking Performance Pad or press the [RELOOP/EXIT] button to cancel loop playback.
- If the BPM can't be detected, it's set to 120.

---

## Slip Loop

Slip loop playback continues while pressing a Performance Pad regardless of whether Slip is turned on or off.

---

### Using Slip Loop

#### 1 Press the [SLIP LOOP (RELEASE FX)] button.

The unit switches to Slip Loop mode.

#### 2 Press a Performance Pad.

Loop playback starts according to the BPM of the track and the number of beats or bars assigned to the Performance Pad, and continues until you release the Performance Pad.

- The number of beats or bars for Slip Loop is assigned to the Performance Pads as follows.

1/16 beat	1/8 beat	1/4 beat	1/2 beat
1 beat	2 beats	1/3 beat	3/4 beat

- Normal playback continues in the background while the Slip Loop is playing.
- Release the Performance Pad to cancel Slip Loop playback. Normal playback starts from the exact point the track would have reached by then.
- If the BPM can't be detected, it's set to 120.

---

---

## Release FX

Release FX are applied while pressing Performance Pads.

---

### Using Release FX

#### 1 Press the [SLIP LOOP (RELEASE FX)] button.

The unit switches to Release FX mode.

#### 2 Press a Performance Pad.

The Release FX is applied until you release the Performance Pad.

- Release FX are assigned to the Performance Pads as follows.

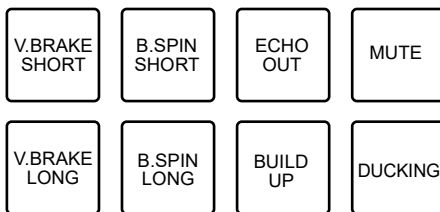

- **V.BRAKE SHORT/V.BRAKE LONG:** Gradually slows down playback speed and then stops playback.
  - **B.SPIN SHORT/B.SPIN LONG:** Performs fast reverse playback and then stops playback.
  - **ECHO OUT:** Adds an echo-like effect by playing a 1-Beat Loop and fading out the sound.
  - **BUILD UP:** Creates a Build Up by gradually reducing the loop length.
  - **MUTE:** Mutes the playback sound.
  - **DUCKING:** Changes the volume according to the beat and fades out the sound by adding a ducking-like effect.
- Press a Performance Pad while pressing the [SHIFT] button to continue the Release FX even if you release the pad.

---

## Beat Jump/Loop Move

You can instantly move the playback point without changing the rhythm of a track that's playing.

---

### Using Beat Jump/Loop Move

#### 1 Press the [BEAT JUMP (BEAT JUMP 2)] button.

The unit switches to Beat Jump mode.

#### 2 Press a Performance Pad.

The playback point jumps by the number of beats or bars assigned to the Performance Pad.

- The number of beats or bars for Beat Jump/Loop Move is assigned to the Performance Pads as follows. Press the [BEAT LOOP (BEAT LOOP 2)] button in Beat Jump mode to switch between Beat Jump mode and Beat Jump 2 mode.

Beat Jump mode:

1 beat REV	1 beat FWD	2 beats REV	2 beats FWD
4 beats REV	4 beats FWD	8 beats REV	8 beats FWD

- Beat Jump 2 mode:

1/2 beat REV	1/2 beat FWD	2 beats REV	2 beats FWD
4 beats REV	4 beats FWD	16 beats REV	16 beats FWD

- If you do this during loop playback, a loop is moved by the number of beats.

# Audio output

Follow the procedures below to output and adjust sound.

- Outputting sound (page 87)
- Adjusting the sound (page 88)
- Setting the faders (page 89)

🔊 To output sound to the [BOOTH] terminals, see Using a booth monitor (page 91).

## Channel section/master section

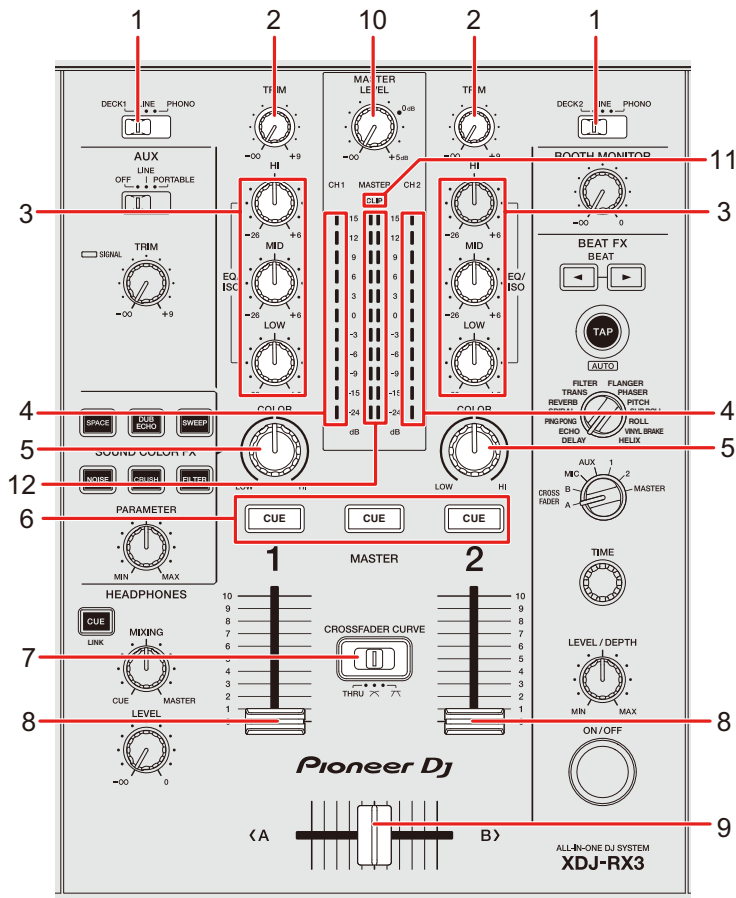

## ❖ Channel section

### 1. Input selector switch

Selects an input sound source.

- **[DECK 1, DECK 2]**: Selects a deck on the unit.
- **[LINE]**: Selects a multi player, etc. connected to the **[LINE]** terminals.
- **[PHONO]**: Selects a turntable connected to the **[PHONO]** terminals.

### 2. TRIM knob

Adjusts the volume for the channel input sound.

### 3. EQ/ISO (HI, MID, LOW) knobs

Adjusts the volume of each frequency band.

Each knob adjusts in the following range.

- **[HI]**: -∞ dB to +6 dB (ISO)/-26 dB to +6 dB (EQ)
- **[MID]**: -∞ dB to +6 dB (ISO)/-26 dB to +6 dB (EQ)
- **[LOW]**: -∞ dB to +6 dB (ISO)/-26 dB to +6 dB (EQ)

### 4. Channel level indicator



Displays the volume level before the sound passes through the channel fader.

### 5. COLOR knob (page 97)

### 6. CUE button (page 90)

### 7. CROSSFADER CURVE switch

Sets the crossfader curve.

- **THRU**: Doesn't use the crossfader.
- : Gradually raises the volume of the sound assigned to the other side as the crossfader is moved from one side (DECK 1 or DECK 2 side) to the other, and decreases the volume of the sound on the side it's moving away from.
- : Steeply raises the volume of the sound assigned to the other side as the crossfader is moved from one side (DECK 1 or DECK 2 side) to the other.

### 8. Channel fader

Adjusts the volume for the channel output sound according to the channel fader curve set with **[CHANNEL FADER CURVE]** in the Utility settings or on the **[SHORTCUT]** screen (pages 115, 120). Moving it up increases the volume, and down decreases the volume.

## 9. **Crossfader**

Adjusts the volume balance between the channel output sounds according to the crossfader curve specified with the [**CROSSFADER CURVE**] switch. Moving it to the [**<A**] side outputs the sound of DECK 1, and to the [**B>**] side outputs the sound of DECK 2.

## ❖ **Master section**

### 10. **MASTER LEVEL knob**

Adjusts the volume for the master sound.

### 11. **CLIP indicator**

Blinks when excessive volume is output from the [**MASTER 1**] or [**MASTER 2**] terminals.

### 12. **Master level indicator**

Displays the volume level of the master sound output to the [**MASTER 1**] and [**MASTER 2**] terminals.

---

---

## Outputting sound

---

### Adjusting the channel input volume

- 1 Slide the input selector switch to select an input sound source.**
- 2 Turn the [**TRIM**] knob to adjust the volume for the input sound.**

The channel level indicator lights up when sound is input to the channel.

---

## Adjusting the channel output volume

- 1 Move the channel fader to adjust the volume for the output sound.
- 2 Move the crossfader to adjust the volume balance of the two channels.
  - You don't need to adjust the crossfader when the [**CROSSFADER CURVE**] switch is set to [**THRU**].

---

## Adjusting the master sound volume

- 1 Turn the [**MASTER LEVEL**] knob to adjust the volume for the master sound.

The master level indicator lights up when the master sound is output.

---

---

## Adjusting the sound

- 1 Turn the [**EQ/ISO (HI, MID, LOW)**] knobs to adjust the volume of each band.
  - Set the function (equalizer or isolator) to adjust with the [**EQ/ISO (HI, MID, LOW)**] knobs in [**EQUALIZER CURVE**] in the Utility settings or on the [**SHORTCUT**] screen (pages 115, 119).



---

## Setting the faders

Set the channel fader and crossfader.

---

### Setting the channel fader

- 1 Press and hold the [MENU/UTILITY] button, or press the [SHORTCUT] button.

The [UTILITY] or [SHORTCUT] screen appears.

- 2 Set the channel fader curve in [CHANNEL FADER CURVE].

➡ Read more: (pages 115, 120).

---

### Setting the crossfader

- 1 Slide the [CROSSFADER CURVE] switch to set the crossfader curve.

---

---

# Monitoring sound

---

---

## Headphones section

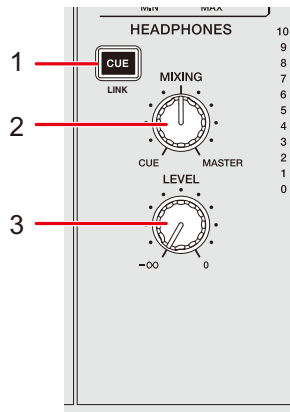

1. **CUE (LINK) button** (page 42)

2. **MIXING knob**

Adjusts the volume balance between the master sound and the channel selected with the [CUE] button.

- Set the knob to [CUE] to monitor only the channel sound, and to [MASTER] to monitor only the master sound.

3. **LEVEL knob**

Adjusts the volume for sound output from the [PHONES] terminals.

---

---

## Monitoring with headphones

1 **Connect headphones to one of the [PHONES] terminals.**

➡ Read more: Front panel (page 20)

2 **Press the [CUE] button on a channel to monitor the channel's sound.**

- You can set the sound output (MONO SPLIT or STEREO) in **[HEADPHONES MONO SPLIT/STEREO]** in the Utility settings or on the **[SHORTCUT]** screen (pages 116, 120).

**3 Turn the [MIXING] knob to adjust the volume balance between the channel sound and the master sound.**

**4 Turn the [LEVEL] knob to adjust the volume.**

---

---

## Booth section

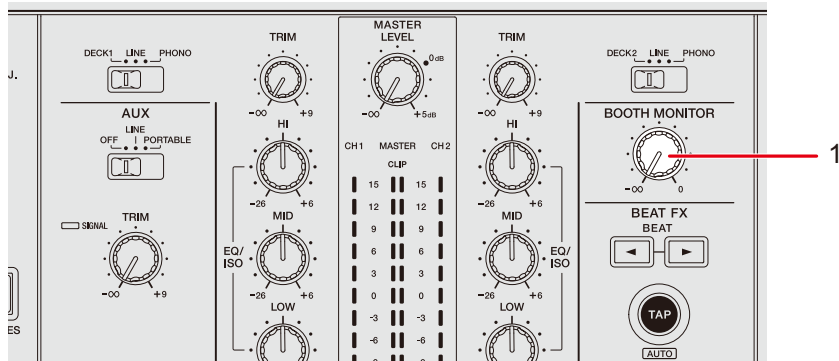

### 1. BOOTH MONITOR knob

Adjusts the volume for the sound output to a booth monitor.

---

---

## Using a booth monitor

**1 Connect a booth monitor to the [BOOTH] terminals.**

➡ Read more: Rear panel (page 20)

**2 Turn the [BOOTH MONITOR] knob to adjust the volume for the output sound.**

---

---

# Microphone

---

---

## MIC section

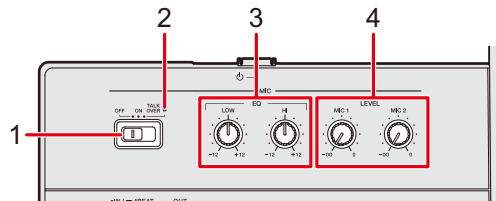

### 1. OFF, ON, TALK OVER selector switch

Sets the microphone sound output.

- [OFF]: Turns the microphone off.
- [ON]: Turns the microphone on.
- [TALK OVER]: Turns microphone talkover on. When sound of -10 dB or more is input to the microphone, the volume other than the microphone channel is attenuated by -24 dB.

### 2. MIC indicator

Indicates the microphone sound output as follows.

- Off: The microphone is off.
- Lights up: The microphone is on.
- Blinks: The microphone talkover is on.

### 3. EQ (HI, LOW) knobs

Adjusts the volume of sound input from the [MIC 1] and [MIC 2] terminals. Each knob adjusts in the following range.

- [HI]: -12 dB to +12 dB
- [LOW]: -12 dB to +12 dB

### 4. LEVEL (MIC 1, MIC 2) knobs

Adjusts the volume of sound input from the [MIC 1] and [MIC 2] terminals.

---

---

## Using a microphone

**1 Connect a microphone to the [MIC 1] or [MIC 2] terminal.**

 Read more: Rear panel (page 20)

**2 Slide the [OFF, ON, TALK OVER] selector switch to set the microphone sound output.**

**3 Turn [LEVEL MIC 1] or [LEVEL MIC 2] knob to adjust the microphone volume level.**

- Note that turning the knob too far clockwise outputs the sound at a high volume.

**4 Turn the [EQ HI] and [EQ LOW] knobs to adjust the volume of each band.**

**5 Speak into the microphone.**

# AUX

## AUX section

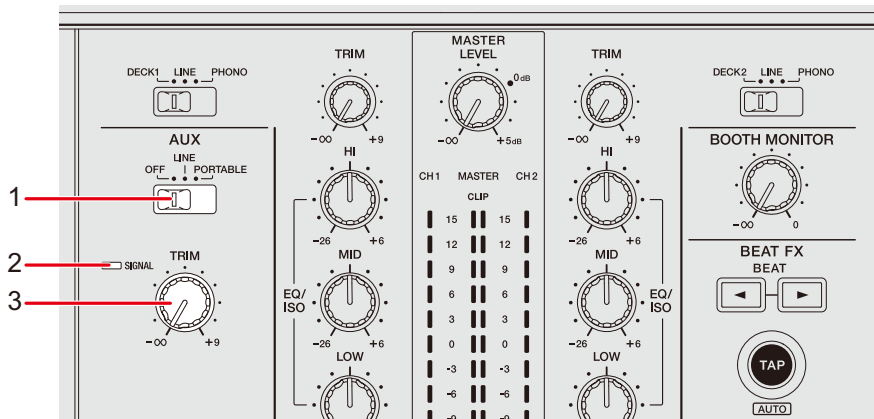

### 1. **AUX (OFF, LINE, PORTABLE) switch**

- **[OFF]**: Mutes the input sound.
- **[LINE]**: Sound is input from the device connected to the **[AUX LINE]** terminals.
- **[PORTABLE]**: Sound is input from the device connected to the **[AUX PORTABLE]** terminal.

### 2. **SIGNAL indicator**

Lights up when a sound signal is input to AUX.

### 3. **TRIM knob**

Adjusts the volume for the input sound of the AUX channel.

---

## Using AUX

**1 Connect an external device to the [AUX LINE] terminals or the [AUX PORTABLE] terminal.**

 Read more: Rear panel (page 20)

**2 Slide the [AUX (OFF, LINE, PORTABLE)] switch to select an external device to use.**

**3 Turn the [TRIM] knob to adjust the volume of the input sound.**

---

---

# Sound Color FX

You can apply a filter or an effect to the sound on any channel.

---

---

## Sound Color FX section

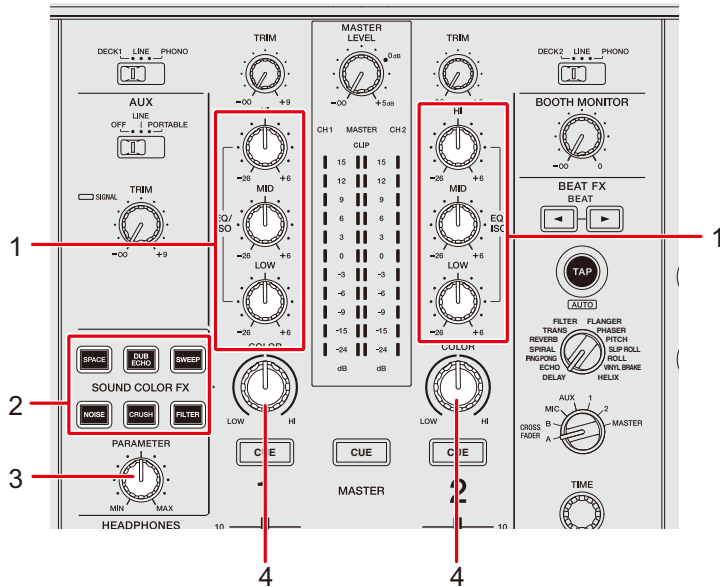

1. **EQ/ISO (HI, MID, LOW) knobs** (page 85)
2. **SOUND COLOR FX buttons**  
Select a SOUND COLOR FX.
3. **PARAMETER knob**  
Adjusts a filter or an effect.
4. **COLOR knob**  
Adjusts an effect.



---

## Using Sound Color FX

 Read more: Sound Color FX types and settings (page 98)

### 1 Press the [SOUND COLOR FX] button.

The selected button blinks.

- The effect is applied to CH 1 and CH 2.

### 2 Turn the [COLOR] knob to adjust the effect.

The effect on the channel you turned the knob for is adjusted.

### 3 Turn the [PARAMETER] knob to adjust the quantitative parameter for the effect.

- Press the button of the effect you're using again to turn the effect off.

---

## Sound Color FX types and settings

You can adjust the following settings with the knobs.

Effect/operation	Description
<b>SPACE</b>	Adds reverberation to the original sound.
<ul style="list-style-type: none"> <li>• <b>COLOR:</b></li> </ul>	<p>Turn counterclockwise to add reverberation to the middle frequency range and high frequency range.</p> <p>Turn clockwise to add reverberation to the middle frequency range and low frequency range.</p>
<ul style="list-style-type: none"> <li>• <b>PARAMETER:</b></li> </ul>	Feedback
<b>DUB ECHO</b>	Adds reverberating echo by outputting the sounds slightly delayed from the original sound several times and attenuating them.
<ul style="list-style-type: none"> <li>• <b>COLOR:</b></li> </ul>	<p>Turn counterclockwise to add reverberating echo to the middle frequency range.</p> <p>Turn clockwise to add reverberating echo to the high frequency range.</p>
<ul style="list-style-type: none"> <li>• <b>PARAMETER:</b></li> </ul>	Feedback
<b>SWEEP</b>	Adds a gate effect (makes the sound tighter and reduces the volume) or a bandpass filter effect.
<ul style="list-style-type: none"> <li>• <b>COLOR:</b></li> </ul>	<p>Turn counterclockwise to add a gate effect.</p> <p>Turn clockwise to gradually narrow the bandwidth of the bandpass filter.</p>
<ul style="list-style-type: none"> <li>• <b>PARAMETER:</b></li> </ul>	Effect level

---

Effect/operation	Description
<b>NOISE</b>	Outputs filtered white noise mixed with the sound of the channel.
<ul style="list-style-type: none"> <li>• <b>COLOR:</b></li> </ul>	<p>Turn counterclockwise to lower the cut-off frequency for the filter which passes white noise through.</p> <p>Turn clockwise to raise the cut-off frequency for the filter which passes white noise through.</p>
<ul style="list-style-type: none"> <li>• <b>PARAMETER:</b></li> </ul>	Volume of the noise
<ul style="list-style-type: none"> <li>• <b>EQ/ISO (HI, MID, LOW):</b></li> </ul>	Volume of the noise
<b>CRUSH</b>	Outputs a 'crushed' version of the original sound.
<ul style="list-style-type: none"> <li>• <b>COLOR:</b></li> </ul>	<p>Turn counterclockwise to increase sound distortion.</p> <p>Turn clockwise to pass the crush sound through the high-pass filter.</p>
<ul style="list-style-type: none"> <li>• <b>PARAMETER:</b></li> </ul>	Effect level
<b>FILTER</b>	Outputs filtered sound.
<ul style="list-style-type: none"> <li>• <b>COLOR:</b></li> </ul>	<p>Turn counterclockwise to lower the cut-off frequency of the low-pass filter.</p> <p>Turn clockwise to raise the cut-off frequency of the high-pass filter.</p>
<ul style="list-style-type: none"> <li>• <b>PARAMETER:</b></li> </ul>	Resonance

---

---

# Beat FX

You can add various effects according to the BPM of the track that's playing.

---

---

## Beat FX section

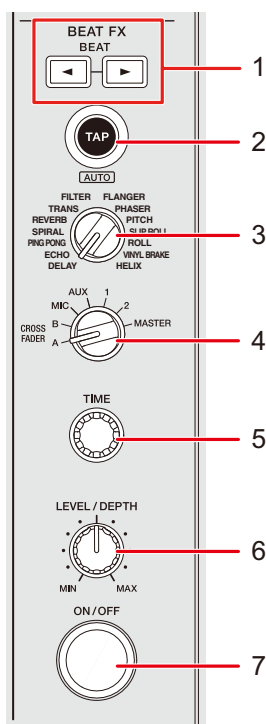

- 1. BEAT ◀▶ button**  
Sets the number of beats for Beat FX.
- 2. TAP (AUTO) button**  
Sets BPM.
  - It's automatically set to AUTO mode when the unit is turned on.
- 3. Beat FX selector switch**  
Selects a Beat FX.
- 4. Beat FX channel selector switch**  
Selects a channel to apply Beat FX to.

5. **TIME knob**  
Adjusts the time parameter for Beat FX.
6. **LEVEL/DEPTH knob**
  - Turn the knob all the way counterclockwise to output the original sound.
7. **ON/OFF button**  
Turns Beat FX on and off. The button blinks when the effect is turned on.

---

---

## Using Beat FX

📖 Read more: Beat FX types and settings (page 104)

### 1 Turn the Beat FX selector switch to select a Beat FX.

- When Beat FX are registered to Beat FX Bank, you can select a Beat FX by touching a Beat FX Bank slot (page 109).

### 2 Turn the Beat FX channel selector switch to select a channel to apply the Beat FX to.

### 3 Press the [BEAT ◀] or [BEAT ▶] button to set a beat fraction to synchronize the effect with.

### 4 Turn the [TIME] knob and [LEVEL/DEPTH] knob to adjust the effect.

### 5 Press the [ON/OFF] button or touch X-PAD to turn the Beat FX on.

The Beat FX is applied to the selected channel.

- Press the [ON/OFF] button again or release X-PAD to turn the Beat FX off.

- To use the X-PAD, touch **[BEAT FX]** on the waveform screen to display the Beat FX controls.



1. **BEAT FX**
2. **X-PAD:** Touch to turn an effect on and off. You can adjust the time and quantitative parameters when you touch or slide your finger on X-PAD.

---

## Setting BPM manually (Tap mode)

### 1 Tap the **[TAP (AUTO)]** button more than twice in time with the beat of the track.

BPM is set according to the average time between taps.

- The beat fraction is set to 1/1 when you set BPM with the **[TAP (AUTO)]** button, and the length of one beat is set as the effect time.
- Turn the **[TIME]** knob while pressing the **[TAP (AUTO)]** button to adjust BPM in increments of 1.
- Press the **[BEAT ◀]** or **[BEAT ▶]** button while pressing the **[TAP (AUTO)]** button to adjust BPM in increments of 0.1.
- Press the **[TAP (AUTO)]** button while pressing the **[SHIFT]** button to automatically set the BPM.

---

## Using Quantize (for Beat FX)

If you use Quantize, the unit adds an effect by automatically synchronizing it with the beat according to the track's grid information analyzed by rekordbox. This happens even if you operate the **[ON/OFF]** button of Beat FX or X-PAD roughly.

- Analyze the tracks in rekordbox beforehand. For details on track analysis, see the rekordbox Instruction Manual (page 8).

### 1 Press the **[SHORTCUT]** button.

The **[SHORTCUT]** screen appears.

 Read more: Changing the settings on the Shortcut screen (page 118)

### 2 Touch **[ON]** in **[QUANTIZE (EFFECT)]**.

Quantize turns on.

## Beat FX types and settings

You can adjust the following settings with the buttons and knobs.

Beat FX/operation	Description
<b>DELAY</b> <sup>1</sup> <sup>2</sup>	Outputs a delay sound once according to the beat.
• <b>BEAT</b> ◀/▶:	Delay time with respect to 1 beat of the BPM (beat fraction): 1/16 to 16 beats
• <b>TIME</b> :	Delay time: 1 to 4000 (ms)
• <b>LEVEL/DEPTH</b> :	Balance between the original sound and the effected sound
• <b>X-PAD</b> :	Delay time
<b>ECHO</b> <sup>1</sup> <sup>2</sup>	Outputs a delay sound several times while attenuating it according to the beat.
• <b>BEAT</b> ◀/▶:	Delay time with respect to 1 beat of the BPM (beat fraction): 1/16 to 16 beats
• <b>TIME</b> :	Delay time: 1 to 4000 (ms)
• <b>LEVEL/DEPTH</b> :	Balance between the original sound and the effected sound
• <b>X-PAD</b> :	Delay time
<b>PING PONG</b> <sup>1</sup> <sup>2</sup>	Outputs a delay sound with different delay times for the left and right several times while attenuating it according to the beat, producing a stereo-like effect.
• <b>BEAT</b> ◀/▶:	Delay time with respect to 1 beat of the BPM (beat fraction): 1/16 to 16 beats
• <b>TIME</b> :	Delay time: 10 to 4000 (ms)
• <b>LEVEL/DEPTH</b> :	Balance between the original sound and the effected sound
• <b>X-PAD</b> :	Delay time



Beat FX/operation	Description
<b>SPIRAL</b> <sup>1</sup> <sup>2</sup>	Adds reverberation to the input sound.
• <b>BEAT</b> ◀/▶:	Delay time with respect to 1 beat of the BPM (beat fraction): 1/16 to 16 beats
• <b>TIME</b> :	Delay time: 10 to 4000 (ms)
• <b>LEVEL/DEPTH</b> :	Balance between the original sound and the effected sound, and feedback
• <b>X-PAD</b> :	Delay time
<b>REVERB</b> <sup>1</sup> <sup>2</sup>	Adds reverberation to the input sound.
• <b>BEAT</b> ◀/▶:	Reverberation level: 1 to 100%
• <b>TIME</b> :	Reverberation level: 1 to 100%
• <b>LEVEL/DEPTH</b> :	Balance between the original sound and the effected sound
• <b>X-PAD</b> :	Cut-off frequency for filter
<b>TRANS</b>	Cyclically cuts the sound according to the beat.
• <b>BEAT</b> ◀/▶:	Cycle of the cut with respect to 1 beat of the BPM (beat fraction): 1/16 to 16 beats
• <b>TIME</b> :	Effect time: 10 to 16000 (ms)
• <b>LEVEL/DEPTH</b> :	Balance between the original sound and the effected sound, and duty
• <b>X-PAD</b> :	Cycle of the cut

Beat FX/operation	Description
<b>FILTER</b>	Cyclically changes the cut-off frequency according to the beat.
• <b>BEAT</b> ◀/▶:	Moving cycle of the effect with respect to 1 beat of the BPM (beat fraction): 1/16 to 64 beats
• <b>TIME</b> :	Moving cycle of the effect: 10 to 32000 (ms)
• <b>LEVEL/DEPTH</b> :	Effect level
• <b>X-PAD</b> :	Cycle to finely fluctuate the effect
<b>FLANGER</b>	Adds a cyclic flanger effect according to the beat.
• <b>BEAT</b> ◀/▶:	Moving cycle of the effect with respect to 1 beat of the BPM (beat fraction): 1/16 to 64 beats
• <b>TIME</b> :	Moving cycle of the effect: 10 to 32000 (ms)
• <b>LEVEL/DEPTH</b> :	Effect level
• <b>X-PAD</b> :	Cycle to finely fluctuate the effect
<b>PHASER</b>	Adds a cyclic phaser effect according to the beat.
• <b>BEAT</b> ◀/▶:	Moving cycle of the effect with respect to 1 beat of the BPM (beat fraction): 1/16 to 64 beats
• <b>TIME</b> :	Moving cycle of the effect: 10 to 32000 (ms)
• <b>LEVEL/DEPTH</b> :	Effect level
• <b>X-PAD</b> :	Cycle to finely fluctuate the effect

Beat FX/operation	Description
<b>PITCH</b>	Changes the pitch of the original sound.
<ul style="list-style-type: none"> <li>• <b>BEAT</b> ◀▶:</li> <li>• <b>TIME</b>:</li> <li>• <b>LEVEL/DEPTH</b>:</li> <li>• <b>X-PAD</b>:</li> </ul>	<p>Pitch of the effect sound: -50 to 100</p> <p>Pitch of the effect sound: -50 to 100</p> <p>Pitch of the effect sound</p> <p>Pitch of the effect sound</p>
<b>SLIP ROLL</b>	<p>Records the input sound when the effect is turned on, and outputs the recorded sound repeatedly according to the specified beat fraction.</p> <p>If the effect time is changed, the input sound is recorded again.</p>
<ul style="list-style-type: none"> <li>• <b>BEAT</b> ◀▶:</li> <li>• <b>TIME</b>:</li> <li>• <b>LEVEL/DEPTH</b>:</li> <li>• <b>X-PAD</b>:</li> </ul>	<p>Effect time with respect to 1 beat of the BPM (beat fraction): 1/16 to 16 beats</p> <p>Effect time: 10 to 4000 (ms)</p> <p>Balance between the original sound and the effected sound</p> <p>Effect time</p>
<b>ROLL</b>	Records the input sound when the effect is turned on, and outputs the recorded sound repeatedly according to the specified beat fraction.
<ul style="list-style-type: none"> <li>• <b>BEAT</b> ◀▶:</li> <li>• <b>TIME</b>:</li> <li>• <b>LEVEL/DEPTH</b>:</li> <li>• <b>X-PAD</b>:</li> </ul>	<p>Effect time with respect to 1 beat of the BPM (beat fraction): 1/16 to 16 beats</p> <p>Effect time: 10 to 4000 (ms)</p> <p>Balance between the original sound and the effected sound</p> <p>Effect time</p>

Beat FX/operation	Description
<b>VINYL BRAKE</b>	Cyclically slows down the playback speed of the input sound gradually according to the beat and then stops playback.
• <b>BEAT ◀/▶:</b>	Cycle of the effect with respect to 1 beat of the BPM (beat fraction): 1/16 to 16 beats
• <b>TIME:</b>	Effect time: 10 to 4000 (ms)
• <b>LEVEL/DEPTH:</b>	Playback speed
• <b>X-PAD:</b>	Effect time
<b>HELIX</b>	Records the input sound and outputs the recorded sound repeatedly according to the specified beat fraction.
• <b>BEAT ◀/▶:</b>	Effect time with respect to 1 beat of the BPM (beat fraction): 1/16 to 16 beats
• <b>TIME:</b>	Effect time: 10 to 4000 (ms)
• <b>LEVEL/DEPTH:</b>	Ratio of sound overlay <ul style="list-style-type: none"> <li>You can change the attenuation rate by turning the <b>[LEVEL/DEPTH]</b> knob all the way counterclockwise and then clockwise. Turn the knob all the way clockwise to fix the output sound.</li> </ul>
• <b>X-PAD:</b>	Effect time

<sup>1</sup> When the Beat FX channel selector switch is set to **[1]** or **[2]**, you can't monitor the effected sound even if you press the **[CUE]** button for the relevant channel.

<sup>2</sup> Only the effect sound remains if you set the channel fader to the **[0]** position to cut the input sound (the effect sound remains even after the effect is turned off).

## Registering Beat FX to Beat FX Bank

You can register up to 4 Beat FX to Beat FX Bank. The registration is saved even if the unit is turned off.

- 1 Turn the Beat FX selector switch to select a Beat FX to register to Beat FX Bank.
- 2 Touch [BEAT FX] on the waveform screen.



1. Beat FX Bank
2. Beat FX

- 3 Touch a Beat FX Bank slot with no Beat FX registered.

The Beat FX selected with the Beat FX selector switch is registered to the Beat FX Bank.

- You can't register a Beat FX to any Beat FX Banks that have one registered already. Touch  to cancel the registration, and then register a Beat FX to the bank.

---

---

# Using DJ software

If you connect a PC/Mac with MIDI software installed, to the unit via a USB cable, you can control the DJ software via the unit.

- To play tracks stored on a PC/Mac with the unit, install the dedicated audio driver software (page 13).
- For details on the unit's MIDI messages, visit the URL below.

[pioneerdj.com/support/](http://pioneerdj.com/support/)

- Install DJ software and configure the audio and MIDI settings on a PC/Mac beforehand.
- You don't need to make MIDI settings when you use rekordbox or Serato DJ Pro with the unit.

---

---

## Controlling DJ software

### 1 Connect a PC/Mac to the unit.

 Read more: Rear panel (page 20)

### 2 Press the [SOURCE] button.

The [SOURCE] screen appears.

 Read more: SOURCE screen (page 22)

### 3 Select [SOFTWARE CONTROL].

The [SOFTWARE CONTROL] screen appears.

### 4 Press the [LOAD 1] or [LOAD 2] button.

The deck on which you press the button switches to control mode.

### 5 Launch the DJ software.

The unit starts communication with the DJ software.

- Some buttons on the unit can't be used for controlling a DJ application.
- Control mode turns off when a track is loaded to the unit from a device other than the currently communicating device that's running the DJ software.
- Touch the deck number of the deck information display on the waveform screen to switch the control deck between 1 and 3, or 2 and 4.
- If you set [**MIXER MODE**] to [**XDJ-RX3**] in the Utility settings, the mixer section will work as a standalone mixer (page 116).

---

---

# Settings

You can change the settings of the unit from the Utility menu or on the **[SHORTCUT]** screen. If you save **[MY SETTINGS]** (function settings of the unit) to a storage device (USB), you can load them to the unit immediately when you arrive in the booth or take over from another DJ, etc.

---

---

## Changing the settings

### 1 Press and hold the **[MENU/UTILITY]** button.

The **[UTILITY]** screen appears.



1. **Category**
2. **Setting items**
3. **Setting values**

### 2 Select a setting item.

➡ Read more: Utility settings (page 113)

### 3 Select a setting value.

- Press the **[MENU/UTILITY]** button to close the **[UTILITY]** screen.



## Utility settings

### ❖ DECK category

\*: Factory setting

Setting item	Description
<b>LOAD LOCK</b> <sup>1</sup>	<p>Determines whether or not you can load another track during playback.</p> <ul style="list-style-type: none"> <li>Setting values: <b>UNLOCK*</b>, <b>LOCK</b></li> </ul>
<b>NEEDLE LOCK</b>	<p>Determines whether or not you can start playback from the point touched on the waveform during playback.</p> <ul style="list-style-type: none"> <li>Setting values: <b>UNLOCK, LOCK*</b></li> <li>When set to [<b>LOCK</b>], you can only start playback from the touched point on the waveform during pause or while touching the top of the jog wheel in Vinyl mode.</li> </ul>
<b>QUANTIZE BEAT VALUE (DECK)</b> <sup>1</sup>	<p>Sets the number of beats for Quantize.</p> <ul style="list-style-type: none"> <li>Setting values: <b>1/8, 1/4, 1/2, 1*</b></li> </ul>
<b>HOT CUE AUTO LOAD</b> <sup>1</sup>	<p>Determines whether or not Hot Cues are automatically called up when you load a track (page 79).</p> <ul style="list-style-type: none"> <li>Setting values: <b>OFF, rekordbox SETTING, ON*</b></li> </ul>
<b>HOT CUE COLOR</b>	<p>Turns on and off the lighting color setting for the [<b>HOT CUE (A to H)</b>] buttons (page 77).</p> <ul style="list-style-type: none"> <li>Setting values: <b>OFF*, ON</b></li> </ul>
<b>AUTO CUE LEVEL</b>	<p>Sets the sound pressure level that Auto Cue recognizes as silence.</p> <ul style="list-style-type: none"> <li>Setting values: <b>-78dB, -72dB, -66dB, -60dB, -54dB, -48dB, -42dB, -36dB, MEMORY*</b></li> <li>[<b>MEMORY</b>] sets the cue point closest to the beginning of a track to an Auto Cue point. [<b>AUTO CUE</b>] lights up in white on the screen.</li> </ul>



Setting item	Description
<b>SLIP FLASHING</b>	<p>Determines whether or not the indicators blink for buttons that can be used for Slip when you press the [SLIP] button.</p> <ul style="list-style-type: none"> <li>Setting values: <b>OFF, ON*</b></li> </ul>
<b>ON AIR DISPLAY</b>	<p>Determines whether or not to display On Air Display on the waveform screen (page 25).</p> <ul style="list-style-type: none"> <li>Setting values: <b>OFF, ON*</b></li> </ul>
<b>VINYL SPEED ADJUST</b>	<p>Sets the adjustment method for the playback and stop speeds in Vinyl mode (page 59).</p> <ul style="list-style-type: none"> <li>Setting values: <b>TOUCH&amp;RELEASE*, TOUCH, RELEASE</b></li> </ul>
<b>PLAY MODE</b>	<p>Sets playback mode.</p> <ul style="list-style-type: none"> <li>Setting values: <b>CONTINUE, SINGLE*, REPEAT, ALL REPEAT</b></li> <li>[<b>CONTINUE</b>]: Turns Auto Cue off when it's turned on, and automatically loads the next track when playback reaches the end of a track.</li> <li>[<b>SINGLE</b>]: Stops playback when playback reaches the end of a track. The next track isn't automatically loaded.</li> <li>[<b>REPEAT</b>]: Repeats the playback of a single track.</li> <li>[<b>ALL REPEAT</b>]: Turns Auto Cue off when it's turned on, and repeats playback of all tracks in the category/folder.</li> </ul>
<b>WAVEFORM CURRENT POSITION</b>	<p>Sets where to display the current playback point on the waveform.</p> <ul style="list-style-type: none"> <li>Setting values: <b>CENTER, LEFT*</b></li> </ul>
<b>WAVEFORM DIVISIONS</b>	<p>Selects time scale or phrase data to display under the playing address.</p> <ul style="list-style-type: none"> <li>Setting values: <b>TIME SCALE, PHRASE*</b></li> <li>[<b>TIME SCALE</b>]: Displays scale marks at 30-second intervals.</li> <li>[<b>PHRASE</b>]: Displays the phrase data analyzed by rekordbox.</li> <li>If phrase data isn't saved, time scale is displayed.</li> </ul>

Setting item	Description
<b>IMAGE ON JOG DISPLAY</b>	<p>Sets an image to display on the artwork display on the jog wheel.</p> <ul style="list-style-type: none"> <li>Setting values: <b>ARTWORK*</b>, <b>CUSTOM IMAGE</b></li> </ul> <ul style="list-style-type: none"> <li>[<b>ARTWORK</b>]: Displays the artwork of the loaded track.</li> <li>[<b>CUSTOM IMAGE</b>]: Displays a JPEG saved in the root directory of the storage device (USB) that the loaded track is saved on. Images larger than 800 x 800 pixels can't be displayed on this unit.</li> </ul>

<sup>1</sup> The settings can be set on the [**SHORTCUT**] screen.

## ❖ MIXER category

\*: Factory setting

Setting item	Description
<b>EQUALIZER CURVE</b> <sup>1</sup>	<p>Sets the function (equalizer or isolator) to adjust with the [<b>EQ/ISO (HI, MID, LOW)</b>] knobs.</p> <ul style="list-style-type: none"> <li>Setting values: <b>EQUALIZER*</b>, <b>ISOLATOR</b></li> </ul>
<b>CHANNEL FADER CURVE</b> <sup>1</sup>	<p>Sets the channel fader curve (page 89).</p> <ul style="list-style-type: none"> <li>Setting values:  <b>CURVE1</b>,  <b>CURVE2*</b>,  <b>CURVE3</b></li> </ul>
<b>MASTER ATTENUATOR</b>	<p>Sets the attenuation level of the sound output from the [<b>MASTER 1</b>] and [<b>MASTER 2</b>] terminals.</p> <ul style="list-style-type: none"> <li>Setting values: <b>-12dB</b>, <b>-6dB</b>, <b>0dB*</b></li> </ul>
<b>BOOTH MONITOR ATTENUATOR</b>	<p>Sets the attenuation level of the sound output from the [<b>BOOTH</b>] terminals.</p> <ul style="list-style-type: none"> <li>Setting values: <b>-12dB</b>, <b>-6dB</b>, <b>0dB*</b></li> </ul>
<b>MIC OUT TO BOOTH</b>	<p>Determines whether or not to output the microphone sound to the [<b>BOOTH</b>] terminals.</p> <ul style="list-style-type: none"> <li>Setting values: <b>ON*</b>, <b>OFF</b></li> </ul>

Setting item	Description
<b>MIC OUT TO MASTER REC</b>	<p>Determines whether or not to output the microphone sound to Master Rec (recording sound).</p> <ul style="list-style-type: none"> <li>Setting values: <b>ON*</b>, <b>OFF</b></li> </ul>
<b>HEADPHONES MONO SPLIT/STEREO</b> <sup>1</sup>	<p>Sets the output method (monaural or stereo) for the headphones monitor sound.</p> <ul style="list-style-type: none"> <li>Setting values: <b>MONO SPLIT</b>, <b>STEREO*</b></li> </ul>
<b>MIXER MODE</b> <sup>1</sup>	<p>Sets the operation mode.</p> <ul style="list-style-type: none"> <li>Setting values: <b>XDJ-RX3*</b>, <b>MIDI CONTROL</b></li> </ul>

<sup>1</sup> The settings can be set on the **[SHORTCUT]** screen.

## ❖ GENERAL category

\*: Factory setting

Setting item	Description
<b>LANGUAGE</b>	Sets the display language.
<b>LCD BRIGHTNESS</b> <sup>1</sup>	<p>Sets the brightness of the screen.</p> <ul style="list-style-type: none"> <li>Setting values: <b>1</b>, <b>2</b>, <b>3*</b>, <b>4</b>, <b>5</b></li> </ul>
<b>JOG LCD BRIGHTNESS</b> <sup>1</sup>	<p>Sets the brightness of the display on the jog wheel.</p> <ul style="list-style-type: none"> <li>Setting values: <b>1</b>, <b>2</b>, <b>3*</b>, <b>4</b>, <b>5</b></li> </ul>
<b>SCREEN SAVER</b>	<p>Sets the screen saver.</p> <ul style="list-style-type: none"> <li>Setting values: <b>OFF</b>, <b>ON*</b></li> <li>When set to <b>[ON]</b>, the screen saver starts if: <ul style="list-style-type: none"> <li>You don't use the unit for more than 5 minutes when a track isn't loaded.</li> <li>You don't use the unit for more than 100 minutes during pause, during cue standby, or after playback reaches the end of a track.</li> </ul> </li> <li>Use the unit to cancel the screen saver.</li> </ul>

Setting item	Description
<b>TOUCH DISPLAY CALIBRATION</b>	<p>Adjusts the touch display calibration with a touch of <b>[+]</b> displayed on the screen.</p> <ul style="list-style-type: none"> <li>• If <b>[+]</b> doesn't move, touch it for a little longer.</li> <li>• Do not use sharp-pointed objects such as a ballpoint pen to make the setting.</li> </ul>
<b>AUTO STANDBY</b>	<p>Sets the auto standby function (page 117).</p> <ul style="list-style-type: none"> <li>• Setting values: <b>OFF</b>, <b>ON*</b></li> </ul>
<b>VERSION No.</b>	Displays the version of the software on the unit.

<sup>1</sup> The settings can be set on the **[SHORTCUT]** screen.

## Auto standby

When **[AUTO STANDBY]** is set to **[ON]**, the unit enters standby mode after 4 hours without being used in the following ways.

- No audio signal is input to the unit.
- No storage device (USB) is connected to the unit.
- No PC/Mac is connected to the unit via the USB port on the rear of the unit.

Press the **[MASTER REC (WAKE UP)]** button to exit standby mode.

- The factory setting is **[ON]**.
- Set **[AUTO STANDBY]** to **[OFF]** if you don't need to use the auto standby function.

---

## Changing the settings on the Shortcut screen

### 1 Press the [SHORTCUT] button.

The [SHORTCUT] screen appears.

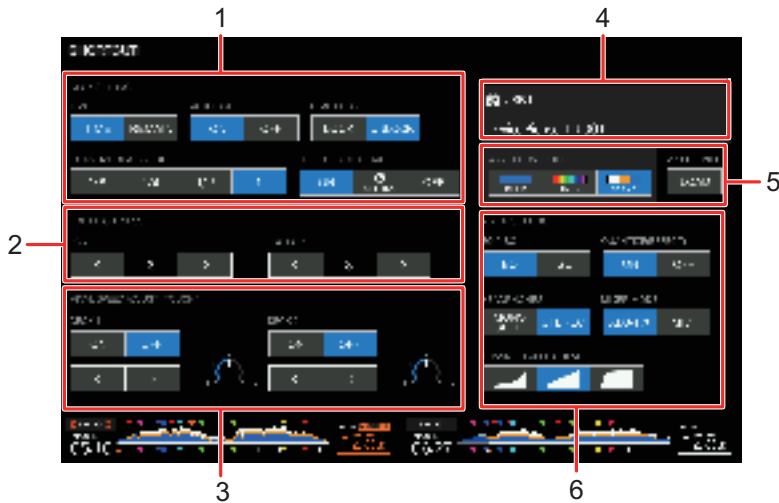

1. DECK SETTING
2. LCD BRIGHTNESS
3. VINYL SPEED ADJUST
4. Device information
5. Device settings
6. MIXER SETTINGS

### 2 Select a setting value.

 Read more: Setting items on the Shortcut screen (page 119)

- Press the [SHORTCUT] button again to close the [SHORTCUT] screen.

## Setting items on the Shortcut screen

Setting item	Description
<b>DECK SETTING</b>	
<b>TIME</b>	Sets the time display ([ <b>TIME</b> ] (elapsed time) or [ <b>REMAIN</b> ] (remaining time)) on both decks.
<b>AUTO CUE</b>	Turns Auto Cue on and off on both decks.
<b>LOAD LOCK</b>	
<b>QUANTIZE BEAT VALUE</b>	Same as the Utility settings (page 113)
<b>HOT CUE AUTO LOAD</b>	
<b>LCD</b>	
<b>LCD BRIGHTNESS</b>	
<b>JOG LCD BRIGHTNESS</b>	Same as the Utility settings (page 113)
<b>VINYL SPEED ADJUST</b>	
<b>DECK 1</b>	Turns on and off the Vinyl Speed Adjust function.
<b>DECK 2</b>	Touch [ <b>&lt;</b> ]/[ <b>&gt;</b> ] to set the speed.
<b>Device settings</b>	
<b>WAVEFORM COLOR</b>	Sets the waveform color.
<b>MY SETTINGS</b>	Touch [ <b>LOAD</b> ] to call up My Settings from a storage device (USB) (page 121).
<b>MIXER SETTING</b>	
<b>EQUALIZER CURVE</b>	Same as the Utility settings (page 113)
<b>QUANTIZE (EFFECT)</b>	Turns Quantize on and off for Beat FX.

Setting item	Description
<b>HEADPHONES MONO SPLIT/ STEREO</b>	
<b>MIXER MODE</b>	Same as the Utility settings (page 113)
<b>CHANNEL FADER CURVE</b>	

---



---

## Calling up My Settings saved on a storage device (USB)

You can call up My Settings from a storage device (USB).

- You can call up My Settings from rekordbox connected in the PRO DJ LINK network.

### 1 Connect a storage device (USB) to the unit.

➤ Read more: Connecting storage devices (USB) (page 33)

### 2 Press the [SOURCE] button.

The [SOURCE] screen appears.

➤ Read more: SOURCE screen (page 22)

### 3 Select a device.

### 4 Press the [SHORTCUT] button.

The [SHORTCUT] screen appears.

### 5 Touch [LOAD] in [MY SETTINGS].

My Settings are called up.

- You can't call up My Settings when a track is playing. Pause the playback before calling up the settings.
- Press the [SHORTCUT] button again to close the [SHORTCUT] screen.

---

---

# Specifications

Power requirements .....	AC 110 V – 240 V, 50 Hz / 60 Hz
Power consumption .....	54 W
Power consumption (standby) .....	0.3 W
Main unit weight .....	9.3 kg / 20.5 lbs.
Max. external dimensions .....	(W x H x D) 728.1 x 118.4 x 469.5 mm / 28.7" x 4.7" x 18.5"
Tolerable operating temperature .....	+5 °C – +35 °C (+41 °F – +95 °F)
Tolerable operating humidity .....	5 % – 85 % (no condensation)

## Audio Section

Sampling rate .....	44.1 kHz
A / D, D / A converter .....	24bit

### Frequency characteristics

USB, LINE, AUX (LINE / PORTABLE), MIC1, MIC2 .....	20 Hz – 20 kHz
--	----------------

### S / N ratio (rated output, A-WEIGHTED)

USB .....	110 dB
LINE .....	94 dB
PHONO .....	83 dB
AUX (LINE) .....	94 dB
AUX (PORTABLE) .....	88 dB
MIC .....	81 dB

### Total harmonic distortion (20 Hz – 20 kHzBW)

USB .....	0.003 %
LINE .....	0.006 %
PHONO .....	0.020 %

### Standard input level / Input impedance

LINE .....	-12 dBu / 47 kΩ
PHONO .....	-52 dBu / 47 kΩ
AUX (LINE) .....	-12 dBu / 47 kΩ
AUX (PORTABLE) .....	-24 dBu / 47 kΩ
MIC .....	-57 dBu / 3 kΩ

### Standard output level / Load impedance / Output impedance

MASTER1 .....	+6 dBu / 10 kΩ / 450 Ω or less
MASTER2 .....	+2 dBu / 10 kΩ / 1 kΩ or less
BOOTH .....	+6 dBu / 10 kΩ / 530 Ω or less
PHONES .....	+8 dBu / 32 Ω / 1 Ω or less

# Specifications

## Rated output level / Load impedance

MASTER1 .....	+25 dBu / 10 k $\Omega$
MASTER2 .....	+21 dBu / 10 k $\Omega$

## Crosstalk

LINE .....	87 dB
PHONO .....	74 dB

## Channel equalizer characteristics

HI.....	$-\infty$ dB – +6 dB (20 kHz)
MID.....	$-\infty$ dB – +6 dB (1 kHz)
LOW .....	$-\infty$ dB – +6 dB (20 Hz)

## Microphone equalizer characteristics

HI.....	-12 dB – +12 dB (10 kHz)
LOW .....	-12 dB – +12 dB (100 Hz)

## Input / Output terminals

### PHONO input terminals

RCA pin jacks .....	2 sets
---------------------	--------

### LINE input terminals

RCA pin jacks .....	2 sets
---------------------	--------

### MIC input terminals

XLR connector & 1/4" TRS jack .....	2 sets
-------------------------------------	--------

### AUX input terminal

RCA pin jacks .....	1 set
3.5 mm stereo mini jack .....	1 set

### MASTER1 output terminal

XLR connector .....	1 set
---------------------	-------

### MASTER2 output terminal

RCA pin jacks .....	1 set
---------------------	-------

### BOOTH output terminal

1/4" TRS jack .....	1 set
---------------------	-------

### PHONES output terminal

1/4" stereo phone jack .....	1 set
3.5 mm stereo mini jack .....	1 set

### USB terminals

A type .....	2 sets
Power supply .....	5 V / 1 A or less
B type .....	1 set

The specifications and design of this product are subject to change without notice.

---

---

# Additional information

---

---

## Troubleshooting

If you think something is wrong with the unit, check the information below and refer to the [FAQ] for the XDJ-RX3 at the URL below.

[pioneerdj.com/support/](http://pioneerdj.com/support/)

- Inspect devices connected with the unit.
- The unit may restore proper operation after you turn it off and on.

If the problems continue, read the “Precautions for Use” and consult an authorized service company or your dealer.

---

---

## Error display

### ❖ E-8302 (Error type: CANNOT PLAY TRACK)

The unit can't read audio files from the storage device.

The audio files may be corrupted.

Check if the files can be played with another player that supports files in the formats supported by this unit.

### ❖ E-8304/E-8305 (Error type: UNSUPPORTED FILE FORMAT)

The loaded audio file is in a format that isn't supported by this unit.

Play an audio file in a format that's supported by this unit (page 10).

---

---

## LCD display

- Small black or shining points may appear on the LCD display. This is a phenomenon inherent to LCD displays and not a malfunction.
- When using the unit in cold places, the LCD display may be dark for a while after the power is turned on. Normal brightness will restore after a while.
- When the LCD display is exposed to direct sunlight, the light will reflect off it, making it difficult to see. Block the direct sunlight to improve visibility of the display.

---

---

## Cleaning

Wipe with a dry soft cloth.

- Do not use organic solvents, acids or alkalis for cleaning.

---

---

## Touch screen

- Operate the touch screen with your fingertip. Do not press it with excessive force.
- Do not operate the touch screen with hard and sharp-pointed objects such as a ballpoint pen, mechanical pencil, or sharp fingernail.

---

### Trademarks and registered trademarks

- rekordbox™ is a trademark or registered trademark of AlphaTheta Corporation.
- PRO DJ LINK™ is a trademark or registered trademark of AlphaTheta Corporation.
- Mac, macOS and Finder are trademarks of Apple Inc., registered in the U.S. and other countries.
- Windows is a registered trademark of Microsoft Corporation in the U.S. and other countries.
- ASIO is a trademark or registered trademark of Steinberg Media Technologies GmbH.
- Serato DJ Pro is a registered trademark of Serato Limited.
- iOS is a trademark containing Cisco trademark signs in the U.S. and other countries.
- Android is a trademark of Google LLC.

Other product, technology and company names, etc. mentioned herein are trademarks or registered trademarks of their respective owners.

#### **About using MP3 files**

This product has been licensed for nonprofit use. This product has not been licensed for commercial purposes (for profit-making use), such as broadcasting (terrestrial, satellite, cable or other types of broadcasting), streaming on the Internet, Intranet (a corporate network) or other types of networks or distributing of electronic information (online digital music distribution service). You need to acquire the corresponding licenses for such uses. For details, see <http://www.mp3licensing.com>.

---

## Cautions on copyrights

rekordbox restricts playback and duplication of copyright-protected music contents.

- When coded data, etc., for protecting the copyright is embedded in the music contents, it may not be possible to operate the program normally.
- When rekordbox detects that coded data, etc., for protecting the copyright is embedded in the music contents, processing (playback, reading, etc.) may stop.

Recordings you have made are for your personal enjoyment and according to copyright laws may not be used without the consent of the copyright holder.

- Music recorded from CDs, etc., is protected by the copyright laws of individual countries and by international treaties. It is the full responsibility of the person who has recorded the music to ensure that it is used legally.
- When handling music downloaded from the Internet, etc., it is the full responsibility of the person who has downloaded the music to ensure that it is used in accordance with the contract concluded with the download site.

The specifications and design of this product are subject to change without notice.

© 2021 AlphaTheta Corporation. All rights reserved.

<DRI1702-A>