

Pioneer Dj

DJ MIXER

DJM-450

<http://pionerdj.com/support/>

<http://rekordbox.com/>

The Pioneer DJ site shown above offers FAQs, information on software, and various other types of information and services to allow you to use your product in greater comfort.

Operating Instructions

Contents

How to read this manual

Thank you for buying this Pioneer DJ product.

Be sure to read this manual and the "Operating Instructions (Quick Start Guide)" included with the unit. Both documents include important information that you should understand before using this product.

- In this manual, names of channels and buttons indicated on the product, names of menus in the software, etc., are indicated within square brackets ([]). (e.g. **[MASTER]** channel, **[ON/OFF]**, **[Start]** menu)
- Please note that the screens and specifications of the software described in this manual as well as the external appearance and specifications of the hardware are currently under development and may differ from the final specifications.
- Please note that depending on the operating system version, web browser settings, etc., operation may differ from the procedures described in this manual.
- Please note that the language on the screens of the software describes in this guide may differ from the language on your screens.

01 Before start

| | |
|----------------|---|
| Features | 3 |
|----------------|---|

02 Part names and functions

| | |
|---------------------|---|
| Rear panel | 4 |
| Control Panel | 5 |

03 Connections

| | |
|-----------------------------------|---|
| Connecting input terminals..... | 7 |
| Connecting output terminals | 8 |

04 Operation

| | |
|--------------------------|----|
| Basic Operation | 9 |
| Advanced Operations..... | 10 |

05 Types of effects

| | |
|--------------------------------------|----|
| Types of SOUND COLOR FX effects..... | 12 |
| Types of BEAT FX | 12 |

06 Using rekordbox

| | |
|---|----|
| About rekordbox | 14 |
| Installing rekordbox | 14 |
| Starting rekordbox | 16 |
| Preparing rekordbox..... | 16 |
| Adding audio tracks into [Collection] | 17 |

07 Using the DVS system

| | |
|--|----|
| About the settings of rekordbox dj | 18 |
| Setting the control signals..... | 18 |

08 Using an application other than rekordbox dj

| | |
|--------------------------------------|----|
| Installing the driver software | 19 |
|--------------------------------------|----|

09 Changing the settings

| | |
|---|----|
| Setting preferences | 22 |
| Change Procedure | 22 |
| About the auto standby function..... | 22 |
| About the setting utility software | 22 |
| Checking the latest information on the driver software..... | 23 |
| [Mixer Audio Output] pulldown menu list | 24 |

10 Additional information

| | |
|--|----|
| Troubleshooting | 25 |
| Block Diagram | 26 |
| About trademarks and registered trademarks | 27 |
| Cautions on copyrights | 27 |
| Software license notice | 27 |

Before start

Features

This unit is a home mixer for DJs. It is the next in the DJM series from Pioneer DJ, the world standard in the disco and club scene. This unit not only has functions such as SOUND COLOR FX and BEAT FX, but it can also support the DJ with its high operability panel layout and connect with various equipment.

STANDARD LAYOUT

This unit has an operating panel layout which is adopted from the Pioneer DJ DJM series, a world standard design for DJ mixers. This enables you to perform in the same way as a club DJ.

EQ & FADER

This unit is designed with EQ CURVE and FADER CURVE which are the same as the DJM-900NXS2 unit used in clubs.

MAGVEL FADER: This unit is designed with cross fader which is our proprietary magnetic system. MAGVEL FADER is highly durable and capable of being operated more than 10 million times, yet is capable of delicate and fine adjustments. It is also good for powerful scratching.

3 BAND EQ/ISOLATOR: This unit is designed with a 3-band equalizer for adjusting treble, midrange, and bass separately. Not only can you change the tone, but you can also mute each sound range by turning its controller to the left.

FX

This unit has SOUND COLOR FX, BEAT FX, and SEND/RETURN, which are well-received by DJs using the DJM-900NXS2 in clubs.

SOUND COLOR FX: The unit has 4 types of effects.

You can adjust the sound of a track to your favorite quality by turning the **[COLOR]** controls. Additionally, turning the **[PARAMETER]** control can vary the expression, which helps when improvising.

BEAT FX: This enables eight different effects in conjunction with BPM, to provide various performances.

SEND/RETURN: This function allows you to connect to a mobile device. With a simple connection, you can use innumerable effect applications on your mobile device in conjunction with the effects built into this unit. This unit is designed with the INSERT method and RETURN AUX method. The RETURN AUX method can mix the original sound with the effect sound to suit your needs, providing unique performances.

“rekordbox dj” and “rekordbox dvs”

This unit comes with a license key for “rekordbox dj” and “rekordbox dvs”, which are DJ applications to make tracks on your PC/Mac to be played with a turn table/Control Vinyl. This unit is equipped with an internal sound card, enabling you to control “rekordbox dj” and “rekordbox dvs” by only connecting a USB cable to your PC/Mac, without complicated settings. Only the unit, turn table/Control Vinyl, and PC/Mac are required to use these applications.

About rekordbox

rekordbox is comprehensive software which can manage audio tracks for DJ performances.

“rekordbox dj” is the DJ performance function of rekordbox. For more details, refer to *Using rekordbox dj* (p.14).

Part names and functions

Rear panel

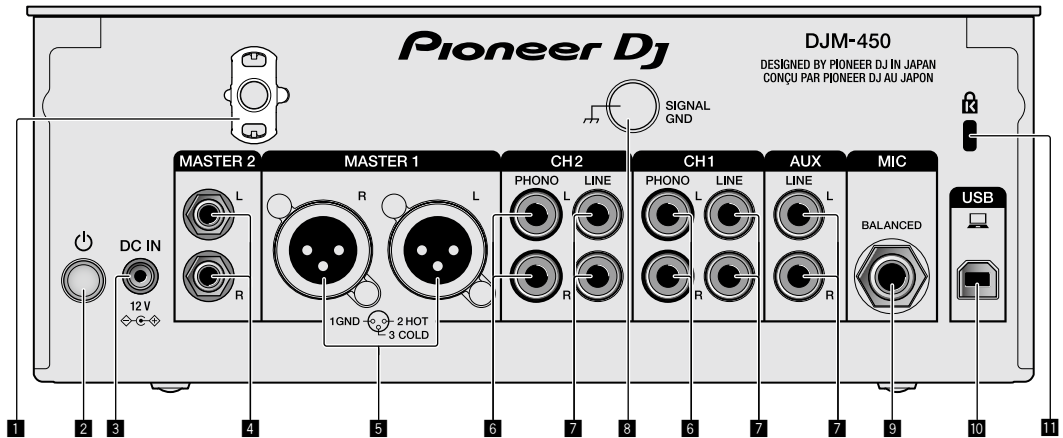

1 Cord hook

Hook the power cord of the AC adaptor to avoid accidentally disconnecting it from the unit.

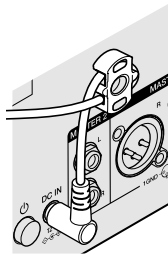

2 POWER button (page 9)

Turn on/off this unit.

3 DC IN terminal (page 7)

Connect the DC plug of the supplied AC adaptor. Connect all other equipment, then connect the power cord. Only use the power cord and AC adaptor supplied with this unit.

4 MASTER2 output terminals (page 8)

Connect to the analog input terminals of a power amplifier, etc.

5 MASTER1 output terminals (page 8)

Connect your equipment, such as a power speaker or a power amplifier, to the analog input terminal. Use these terminals as balanced output.

Do not accidentally insert the power cord of the supplied AC adaptor or the power cord of the equipment.

Do not connect to a terminal which can supply phantom power.

6 PHONO input terminals (page 7)

Connect to a phono level (MM cartridge) output device. Do not input line level signals.

7 LINE input terminals (page 7)

Connect to a DJ player or a line level output component.

8 SIGNAL GND terminal (page 7)

Connect an analog player's ground wire. This helps reduce noise when the analog player is connected.

9 MIC input terminal (page 7)

Connect a microphone.

10 USB terminal (page 7)

Connect to a computer.

11 Kensington security slot

Control Panel

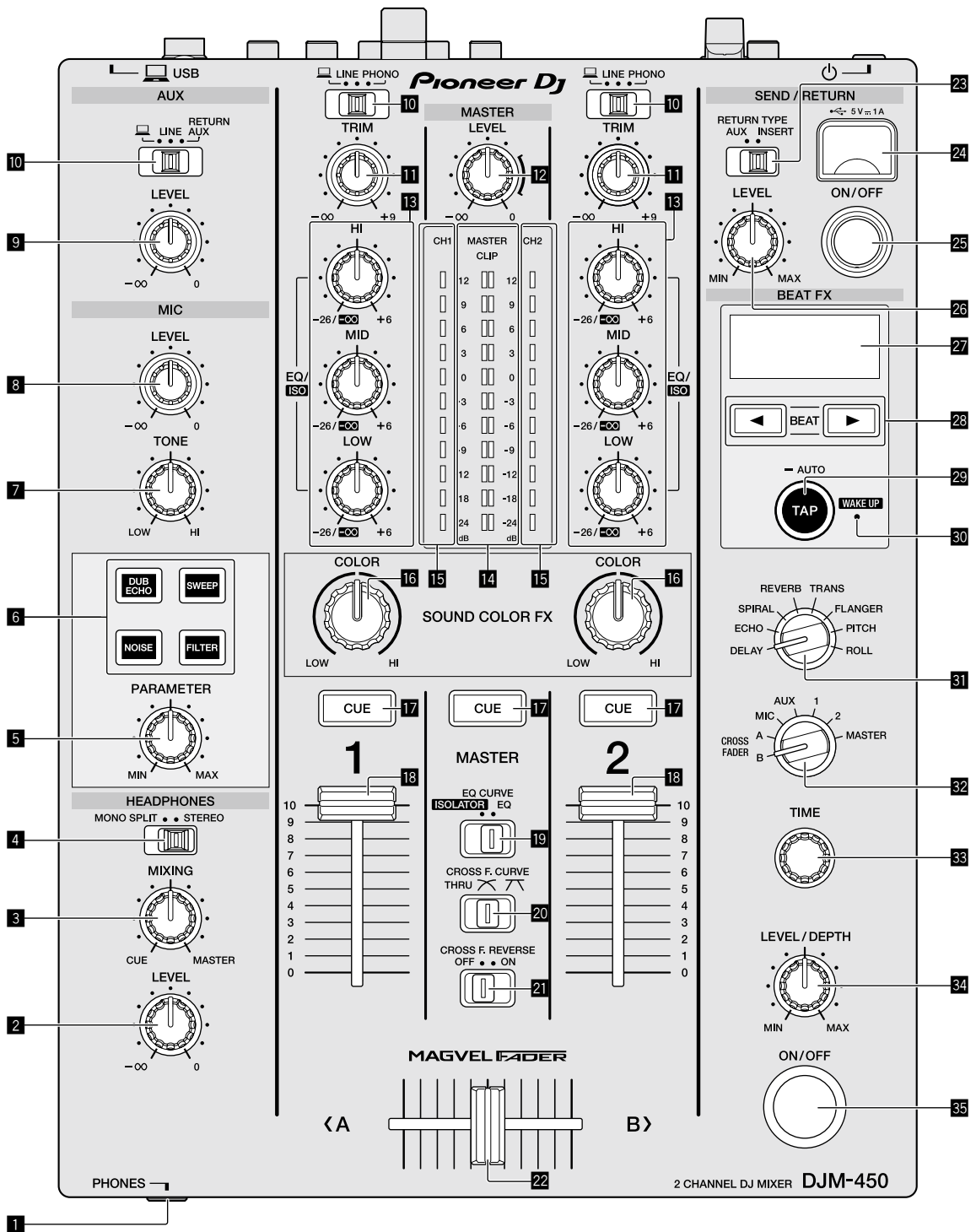

1 PHONES terminal (page 8)

Connect headphones.
This unit supports 1/4" stereo phone plugs and 3.5 mm stereo mini plugs.

2 HEADPHONES LEVEL control (page 9)

Adjust the sound level output from the headphones.

3 HEADPHONES MIXING control (page 9)

Adjust the monitor volume balance of the sound of channels for which the [CUE] button is pressed and the sound of the [MASTER] channel.

4 MONO SPLIT, STEREO selector switch (page 9)

Switch how the monitor sound output from the headphones is distributed.

- 5 PARAMETER control (page 10)**
Adjust the SOUND COLOR FX parameter.
- 6 SOUND COLOR FX selector button (page 10)**
Turn on/off the SOUND COLOR FX effects.
- 7 MIC TONE control (page 9)**
Adjust the sound quality from the microphone.
- 8 MIC LEVEL control (page 9)**
Adjust the volume to output from the microphone.
- 9 LEVEL control**
Adjust the volume from the AUX input.
- 10 Input selector switches (page 9)**
Select an input source on each channel.
- 11 TRIM control (page 9)**
Adjust the volume from each channel.
- 12 MASTER LEVEL control (page 9)**
Adjust the volume from the [MASTER1] or [MASTER2] output.
- 13 EQ/ISO (HI, MID, LOW) controls (page 9)**
Adjust the sound quality of the respective channels.
- 14 Master Level indicator (page 9)**
It shows the volume from the MASTER output.
When the volume is too loud, the [CLIP] indicator flashes. In this case, turn down the volume.
— Slow flashing: sound will become distorted.
— Fast flashing: sound is distorted.
- 15 Channel Level indicator (page 9)**
It shows the volume before passing the channel fader.
- 16 COLOR control (page 10)**
Change the parameters of the SOUND COLOR FX of the different channels.
- 17 CUE button (page 9)**
Press the [CUE] button for the channel you want to monitor.
- 18 Channel Fader (page 9)**
Adjust the volume of each channel.
- 19 EQ CURVE (ISOLATOR, EQ) selector switch (page 9)**
Switch the function of the [EQ/ISO (HI, MID, LOW)] controls.
- 20 CROSS F.CURVE (THRU, , ) selector switch (page 9)**
This switches the cross fader curve characteristics.
- 21 CROSS F. REVERSE switch (page 9)**
Turn on/off the cross fader reverse function.
- 22 Cross fader (page 9)**
Sound outputs following the curve selected by the [CROSS F.CURVE] selector switch.
- 23 RETURN TYPE (AUX, INSERT) selector switch (page 10)**
Select the SEND/RETURN method.
- 24 Mobile device connection terminal (USB port) (page 8)**
Connect a mobile device.
- 25 SEND/RETURN ON/OFF button (page 10)**
Turn SEND/RETURN on and off.
- 26 SEND/RETURN LEVEL control (page 10)**
Adjust the sound level of SEND/RETURN.
- 27 Display (page 10)**
BPM, effect parameter, etc., are displayed.
- 28 BEAT ◀, ▶ buttons (page 10)**
Set the beat fraction for synchronizing the effect sound.
- 29 TAP (AUTO, WAKE UP) button (page 10)**
— TAP: Tap this button to enter BPM.
— AUTO: Press and hold this button to change the BPM measurement mode.
— WAKE UP: Press this button to cancel the standby state.
- 30 WAKE UP indicator (page 10)**
This indicator is lit when the unit is in the standby state.
- 31 Beat effect selector switch (page 10)**
Switch the BEAT FX effect type.
- 32 Effect channel selector switch (page 10)**
Switch the channel to which the BEAT FX and SEND/RETURN are to be applied.
- 33 TIME control (page 10)**
Adjust the BEAT FX's time parameter.
- 34 LEVEL/DEPTH control (page 10)**
Adjust the BEAT FX's quantitative parameter.
- 35 Beat FX ON/OFF button (page 10)**
Turn BEAT FX on/off.

Do not pull on the channel fader and cross fader knobs with excessive force. The knobs have a structure by which they cannot be pulled off easily. Pulling the knobs strongly may result in damaging the unit.

Connections

Be sure to turn off the power and unplug the power cord from the power outlet whenever making or changing connections.

Connect the power cord after all the connections between devices have been completed.

Be sure to use the included power cord.

Refer to the operating instructions for the component to be connected.

- Connect this unit and the computer directly using a USB cable.
- Use USB cables that conform to USB 2.0.
- USB hubs cannot be used.

Connecting input terminals

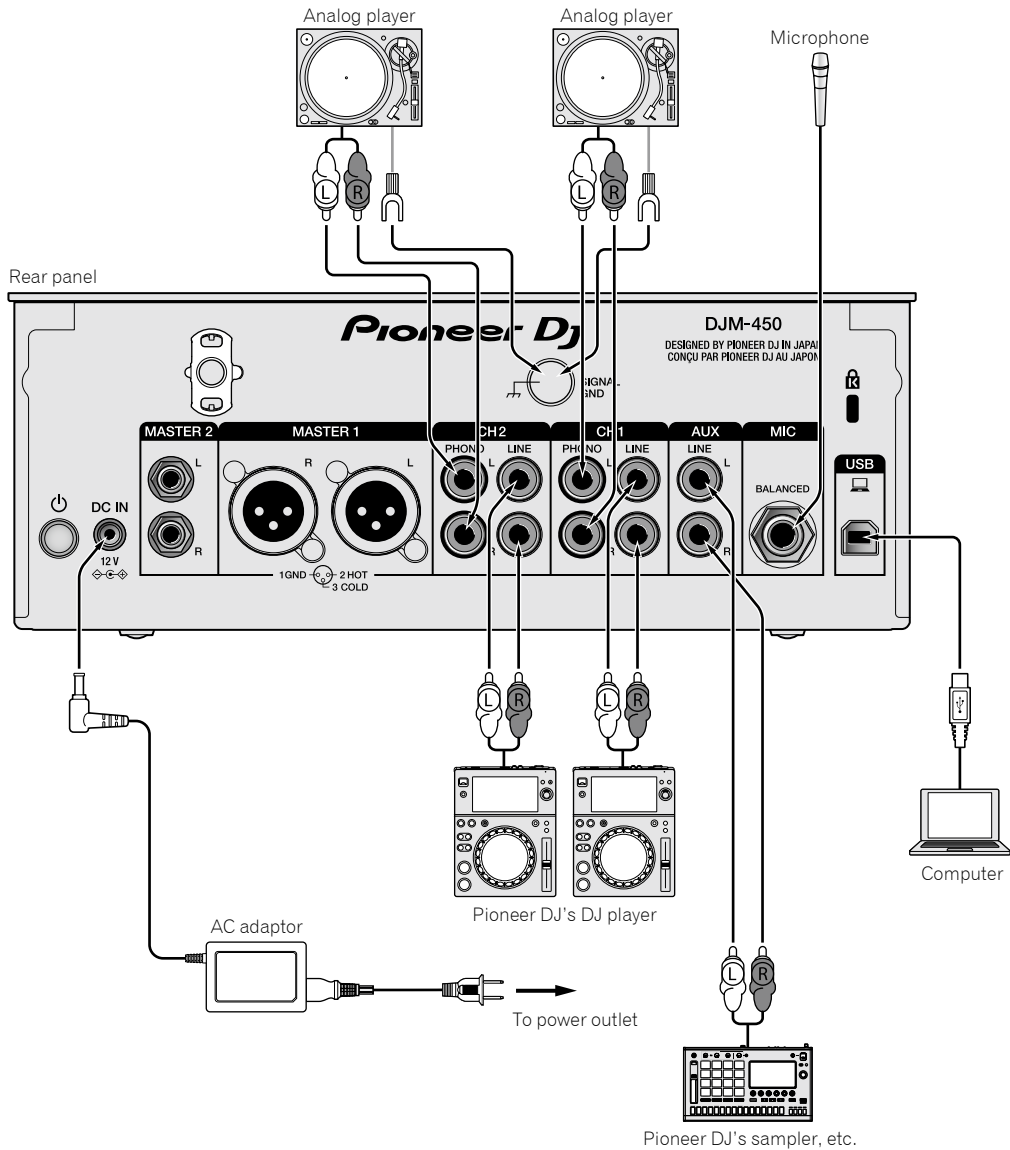

Connecting output terminals

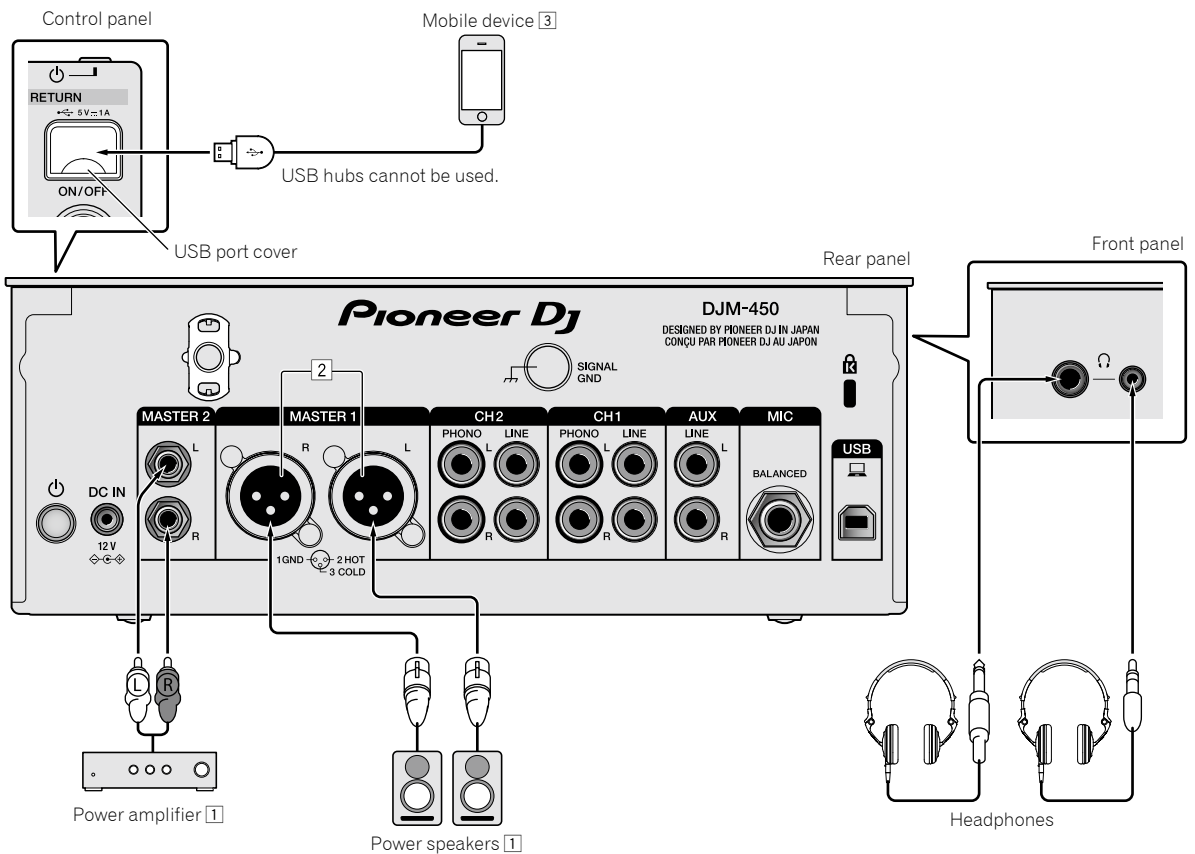

- ❶ Be sure to use the **[MASTER1]** output terminals only for a balanced output. Connection with an unbalanced input (such as RCA) using an XLR to RCA converter cable (or converter adapter), etc., may lower the sound quality and/or result in noise. For connection with an unbalanced input (such as RCA), use the **[MASTER2]** output terminals.
- ❷ **Be careful not to accidentally insert the power cord of another unit to the [MASTER1] output terminals. Do not connect a terminal which is supplied with phantom power to the [MASTER1] output terminals.**
- ❸ When connecting a mobile device, use the cable supplied with the device. For information on compatible mobile devices, see the Pioneer DJ site below.
<http://pioneerdj.com/support/>

Operation

Basic Operation

Outputting sound

1 Press the [POWER] button.

Turn on the unit.

2 Set the input selector switches.

Select the input sources for the different channels from among the devices connected to this unit.

- : Audio from a computer connected to the [USB] terminal is selected.
- [LINE]: Audio from a device connected to the [LINE] input terminal is selected.
- [PHONO]: Audio from analog players connected to the [PHONO] input terminals is selected.

3 Turn the [TRIM] control.

Adjust the level of audio signals input for each channel.

The corresponding channel level indicator lights when audio signals are being properly input to that channel.

4 Move the channel fader up.

Adjust the level of audio signals output for each channel.

5 Set the cross fader.

This operation is not necessary when the [CROSS F.CURVE] selector switch is set to [THRU].

6 Turn the [MASTER LEVEL] control.

Audio signals are output from the [MASTER1] and [MASTER2] output terminals.

The master level indicator lights.

Adjusting the sound quality

1 Set the [EQ CURVE (ISOLATOR, EQ)] selector switch.

- [ISOLATOR]: The isolator function is set.
- [EQ]: The equalizer function is set.

2 Turn the [EQ/ISO (HI, MID, LOW)] controls for the respective channels.

The adjustable ranges for the respective controls are as shown below.

- [HI]: -26 dB to +6 dB (20 kHz)
- [MID]: -26 dB to +6 dB (1 kHz)
- [LOW]: -26 dB to +6 dB (20 Hz)

Monitoring sound with headphones

1 Connect headphones to the [PHONES] terminal.

2 Press the [CUE] button(s) for the channel(s) you want to monitor.

3 Set the [MONO SPLIT, STEREO] selector switch.

- [MONO SPLIT]: The sound of the channels for which the [CUE] button is pressed is output to the left channel, and the [MASTER] channel sound is output to the right channel.
- [STEREO]: The sound of the channels for which the [CUE] button is pressed is output in stereo.

4 Turn the [HEADPHONES MIXING] control.



Adjust the monitor volume balance of sound from channels for which the [CUE] button is pressed and the [MASTER] channel.

5 Turn the [HEADPHONES LEVEL] control.

Adjust the volume for the headphones.

Setting the fader curve

Switch the [CROSS F.CURVE (THRU, ,) selector switch.

- [THRU]: Set to this option when not using the cross fader.
- : The curve is increased slowly.
- : The curve is increased steeply. (If the cross fader is moved from the extreme left or right position, output sound is changed to the opposite side immediately.)

Using the fader reverse function

Turn on the [CROSS F.REVERSE] switch.

When turning on the [CROSS F.REVERSE] switch, the operating direction of the cross fader is reversed.

Using AUX

1 Set the input selector switch for AUX.

- : Audio from a computer connected to the [USB] terminal is selected.
- [LINE]: Audio from a device connected to the [LINE] input terminal is selected.
- [RETURN AUX]: The [RETURN] sound of [SEND/RETURN] is selected.
- When using [RETURN AUX], set [RETURN TYPE] of [SEND/RETURN] to [AUX].
- When using [SEND/RETURN], refer to *Using the SEND/RETURN function* (p.10).

2 Turn the [LEVEL] control.

Adjust the level of audio signal input for the AUX channel.

Using a microphone

1 Connect a microphone to the [MIC] input terminal.

2 Turn the [MIC LEVEL] control.

Adjust the volume from the [MIC] input terminal.

- If the control is turned to the extreme right position, the sound output will be too loud.

3 Turn the [MIC TONE] control to adjust the sound quality.

- When turning the control to the [LOW] position, the high frequency is attenuated.
0 to -12 dB (10 kHz)
- When turning the control to the [HI] position, the low frequency is attenuated.
0 to -12 dB (100 Hz)

Advanced Operations

Using the SOUND COLOR FX function

These are effects that change in association with the [COLOR] control.

1 Press one of the [SOUND COLOR FX] selection buttons.

Select the type of effect.

The pressed button flashes.

- Even if one of [SOUND COLOR FX] selection buttons is already selected, you can press the other button to select it.
- For the types of effects, see *Types of SOUND COLOR FX effects* on page 12.
- The same effect is set for [CH1] or [CH2].

2 Turn the [COLOR] control.

The effect is applied to the channel(s) for which the control(s) was (were) turned.

The effect's quantitative parameter can be adjusted by turning the [PARAMETER] control.

❖ Canceling the SOUND COLOR FX effect

Press the [SOUND COLOR FX] selection button that is flashing.

The effect is canceled.

Using the BEAT FX function

This function lets you instantaneously set various effects according to the tempo (BPM = Beats Per Minute) of the currently playing track.

Display



| | | |
|---|--------------------------------|---|
| 1 | AUTO (TAP) | [AUTO] lights when the BPM measurement mode is set to the auto mode. [TAP] lights when in the manual input mode. |
| 2 | BPM value display (3 digits) | When in the auto mode, this displays the automatically detected BPM value. When the BPM cannot be detected, the previously detected BPM value is displayed and flashes. When in the manual input mode, this displays the BPM value that was input manually. |
| 3 | BPM | This is always lit. This lights according to the selected beat number position. |
| 4 | Beat/parameter display section | Depending on the effect, parameters are displayed when the [BEAT ◀ ▶] buttons are pressed. Blinks when outside the parameter limits. |

1 Press the [TAP] button.

Select the BPM measurement mode.

- [AUTO]: The BPM is measured automatically from the audio signal that is being input. The [AUTO] mode is set when this unit's power is turned on.
- [TAP]: Enter the BPM manually. For instructions on input methods, see *Inputting the BPM manually* on page 10.
To change to the [AUTO] mode, press and hold the [TAP] button.
- The BPM measurement range of [AUTO] is 70 to 180. Depending on a track, it may not measure the BPM correctly. If the BPM is not measured, the BPM value on the display flashes. In this case, press the [TAP] button to enter the BPM manually.

2 Turn the beat effect selector switch.

Select the type of effect.

- For the types of effects, see *Types of BEAT FX* on page 12.

3 Turn the effect channel selector switch.

Select the channel to which the effect is applied.

- [1], [2], [AUX]: The effect is applied to the sound of the respective channel.
- [MIC]: The effect is applied to the sound of [MIC] channel.
- [CROSS FADER A], [CROSS FADER B]: The effect is applied to sound of the cross fader [A] (left) side or [B] (right) side.
- [MASTER]: The effect is applied to the sound of the [MASTER] channel.

4 Press the [BEAT ◀ ▶] buttons.

Set the beat fraction for synchronizing the effect sound.

The effect time corresponding to the beat fraction is set automatically.

5 Press the [BEAT FX ON/OFF] button.

The effect is applied to the sound.

The effect's time parameter can be adjusted by turning the [TIME] control.

The effect's quantitative parameter can be adjusted by turning the [LEVEL/DEPTH] control.

The [BEAT FX ON/OFF] button flashes when the effect is on.

- To cancel the effect, press the [BEAT FX ON/OFF] button again.

❖ Inputting the BPM manually

Tap the [TAP] button at least 2 times in rhythm with the beat (in quarter notes) of the sound being played.

The average value of the interval at which the [TAP] button was tapped is set as the BPM.

- When the BPM is set using the [TAP] button, the beat fraction is set to [1/1] and the time of one beat (quarter note) is set as the effect time.
- The BPM can be set manually by turning the [TIME] control while pressing the [TAP] button.

Using the SEND/RETURN function

Mobile devices can be used.

1 Connect a mobile device.

For information on connecting, see *Connecting output terminals* on page 8.

2 Select the [RETURN TYPE (AUX, INSERT)] selector switch.

Select the SEND/RETURN method.

- [AUX]: The audio of the channel selected in the effects channel is input to the mobile device, and the output from the mobile device is input into the channel selected with [RETURN AUX] using the input selector switch. Original sounds and effect sounds can be mixed together as desired.
To control SEND LEVEL (volume to output to the mobile device), turn the [SEND/RETURN LEVEL] control.

Effect channel selector switch (SEND CH) → [SEND/RETURN LEVEL] control (SEND LEVEL) ⇒ (SEND) ⇒ Mobile device ⇒ (RETURN) ⇒ [SEND/RETURN ON/OFF] button → (Return to [RETURN AUX]) → [AUX LEVEL] control

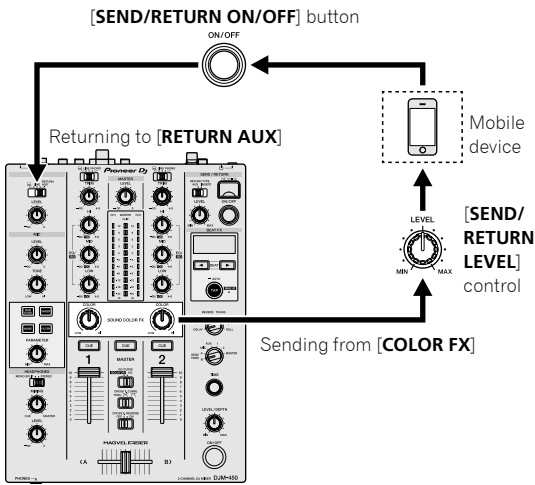

In the following cases, the [SEND/RETURN ON/OFF] button light is turned off. The SEND/RETURN function turns off automatically to prevent the sound being too loud, and you cannot turn it back on.

- When a mobile device is not connected to this unit
- When the [RETURN TYPE (AUX, INSERT)] selector switch is set to [AUX], and the effect channel is set to [AUX] or [MASTER].

Operating software by MIDI interface

This unit outputs the operation information of buttons and controls in universal MIDI format.

When connected by USB cable to a computer or mobile device on which a MIDI-compatible software is installed, the software can be operated from this unit.

Install the software on your computer or mobile device before use. Also, set the software's audio and MIDI related settings.

- For MIDI channel setting instructions, see *Changing the settings* on page 22.
- For details of the MIDI messages on this unit, see the website below. <http://pioneerdj.com/support/>

- 1 Connect this unit to a computer or mobile device.**
 - Computer: Connect the [USB] terminal to your computer.
 - Mobile device: Connect the mobile device connection terminal to the mobile device.

After the connection, transmission of the MIDI messages starts.

- The MIDI timing clock is sent constantly.
- When operating the fader or control, a message corresponding to the position is sent.

— [INSERT]: The audio of the channel selected in the effects channel is input to the mobile device, and the output from the mobile device is input into the channel selected in effect channel.

To control RETURN LEVEL (volume to input from the mobile device), turn the [SEND/RETURN LEVEL] control.

This function is used as the SEND/RETURN function in the same way as the previous DJM series.

Use as SEND/RETURN of the same system as the previous DJM series.

Effect channel selector switch (SEND CH) ⇒ (SEND) ⇒ Mobile device ⇒ (RETURN) ⇒ [SEND/RETURN LEVEL] control (RETURN LEVEL) ⇒ [SEND/RETURN ON/OFF] button ⇒ (Return to the same channel) ⇒ Channel fader

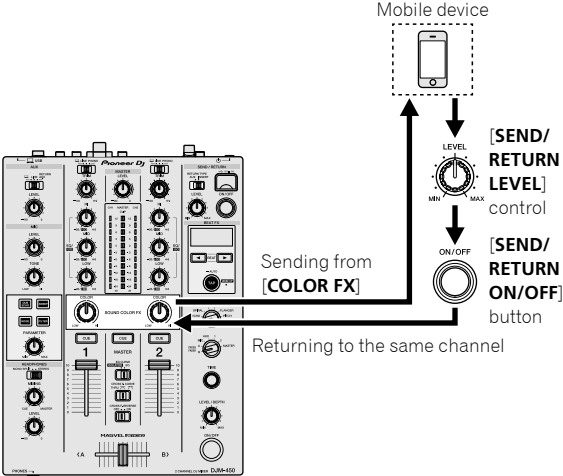

- For details, see *Block Diagram* on page 26.

- 3 Turn the effect channel selector switch.**
Select the channel to add the SEND/RETURN function to.
- 4 Press the [SEND/RETURN ON/OFF] button.**
When the SEND/RETURN function is turned on, the selected sound is sent or returned to the mobile device.
- 5 Turn the [SEND/RETURN LEVEL] control.**
Adjust the SEND/RETURN sound level.

When changing [RETURN TYPE] during the SEND/RETURN function, the SEND/RETURN function is turned off.

Types of effects

Types of SOUND COLOR FX effects

| Effect Name | Descriptions | [COLOR] control | [PARAMETER] control |
|-------------|--|--|--|
| DUB ECHO | The original sound output is delayed with decreasing volume in several steps, and an echo effect is applied. | Turn counterclockwise: The echo effect is applied to the mid-range only. Turn clockwise: The echo effect is applied to the high range only. | Turning the control to the right increases feedback. |
| SWEEP | The gate effect is applied by turning the control to the left. The band pass filter effect is applied by turning the control to the right. | Turn counterclockwise: A gate effect makes the sound tighter, with a reduced sense of volume. Turn to right: The band pass filter bandwidth decreases steadily. | Turning the [COLOR] control to the left adjusts the gate effect. Turn it to the right to tighten the sound. Turning the [COLOR] control to the right adjusts the center frequency. Turn it to the right to increase the center frequency. |
| NOISE | White noise generated inside this unit is mixed with the sound of the channel via the filter and output. | Turn counterclockwise: The cut-off frequency of the filter through which the white noise passes gradually descends. Turn clockwise: The cut-off frequency of the filter through which the white noise passes gradually rises. | Turn to the right to increase white noise volume. • The sound quality can be adjusted by turning the [EQ/ISO (HI, MID, LOW)] control. |
| FILTER | Sound passed through a filter is output. | Turn counterclockwise: The cutoff frequency of the low-pass filter is decreased slowly. Turn clockwise: The cutoff frequency of the high-pass filter is increased slowly. | Turn to the right to increase resonance. |

Types of BEAT FX

DELAY^[1]

A delay sound is output once according to the beat fraction set with the [BEAT ◀, ▶] buttons.

- Lowering the channel faders and cutting the input volume leaves a delay sound.

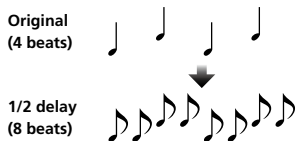

| | |
|--|---|
| BEAT ◀, ▶ buttons (parameter 1) | Sets the delay time between 1/16 and 16 beats with respect to 1 beat of BPM time. |
| TIME control (parameter 2) | Use this to set the delay time. 1 to 4000 (ms) |
| LEVEL/DEPTH control (parameter 3) | Use this to set the balance between the original sound and the delay sound. |

SPIRAL^[1]

This function adds a reverberation effect to the input sound. When the delay time is changed, the pitch changes simultaneously.

- Lowering the channel faders and cutting the input volume leaves an effect sound.

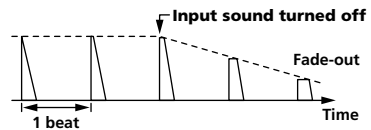

| | |
|--|---|
| BEAT ◀, ▶ buttons (parameter 1) | Sets the delay time between 1/16 and 16 beats with respect to 1 beat of BPM time. |
| TIME control (parameter 2) | Use this to set the delay time. 10 to 4000 (ms) |
| LEVEL/DEPTH control (parameter 3) | Sets feedback, and the balance between the original sound and the effect sound. |

ECHO^[1]

A delay sound is output several times and gradually attenuated according to the beat fraction set with the [BEAT ◀, ▶] buttons.

- Lowering the channel faders and cutting the input volume leaves an echo sound, producing a fade out.

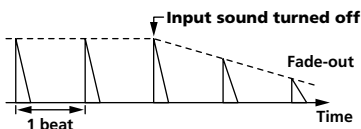

| | |
|--|---|
| BEAT ◀, ▶ buttons (parameter 1) | Sets the delay time between 1/16 and 16 beats with respect to 1 beat of BPM time. |
| TIME control (parameter 2) | Use this to set the delay time. 1 to 4000 (ms) |
| LEVEL/DEPTH control (parameter 3) | Use this to set the balance between the original sound and the echo sound. |

REVERB

This function adds a reverberation effect to the input sound.

- Lowering the channel faders and cutting the input volume leaves a delay sound.

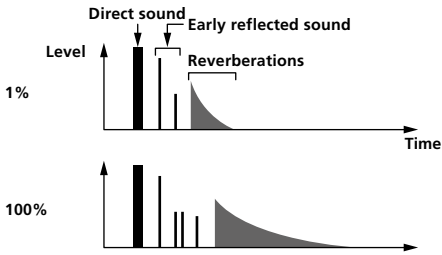

| | |
|--|---|
| BEAT ◀, ▶ buttons (parameter 1) | Use these to set the extent of the reverberation effect, from 1 – 100 %. |
| TIME control (parameter 2) | Use this to set the degree of the reverb effect. 1 – 100 (%) |
| LEVEL/DEPTH control (parameter 3) | Sets the balance between the original sound and the effect sound. |

TRANS

The sound is cut according to the beat fraction set with the [BEAT ◀, ▶] buttons.

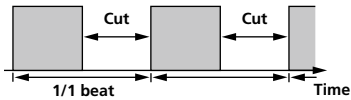

| | |
|--|---|
| BEAT ◀, ▶ buttons (parameter 1) | Sets the cut time between 1/16 and 16 beats with respect to 1 beat of BPM time. |
| TIME control (parameter 2) | Use this to set the effect time. 10 to 16000 (ms) |
| LEVEL/DEPTH control (parameter 3) | Sets the duty and the balance between the original sound and the effect sound. |

FLANGER

A 1-cycle flanger effect is produced according to the beat fraction set with the [BEAT ◀, ▶] buttons.

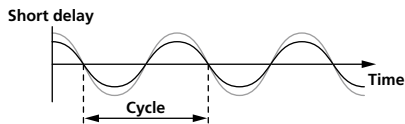

| | |
|--|--|
| BEAT ◀, ▶ buttons (parameter 1) | Sets effect time between 1/16 and 64 beats with respect to 1 beat of BPM time. |
| TIME control (parameter 2) | Use this to set the cycle by which the flanger effect moves. 10 to 32000 (ms) |
| LEVEL/DEPTH control (parameter 3) | The further the control is turned clockwise, the more the effect is stressed. When turned all the way counterclockwise, only the original sound is output. |

PITCH

Changes the pitch of the source sound.

| | |
|--|--|
| BEAT ◀, ▶ buttons (parameter 1) | Sets the pitch of the effect sound. -50 100 (%) |
| TIME control (parameter 2) | Sets the pitch of the effect sound. -50 100 (%) |
| LEVEL/DEPTH control (parameter 3) | Sets the pitch of the effect sound. Turn fully left to return to the original sound. |

ROLL

The sound being input at the point when the [BEAT FX ON/OFF] button is pressed is recorded, and the recorded sound is output repeatedly according to the beat fraction set with the [BEAT ◀, ▶] buttons.

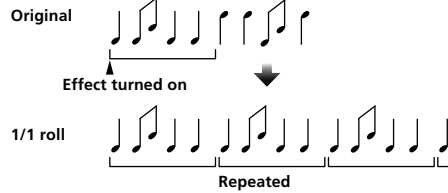

| | |
|--|--|
| BEAT ◀, ▶ buttons (parameter 1) | Sets effect time between 1/16 and 16 beats with respect to 1 beat of BPM time. |
| TIME control (parameter 2) | Use this to set the effect time. 10 to 4000 (ms) |
| LEVEL/DEPTH control (parameter 3) | Use this to set the balance between the original sound and ROLL . |

- 1 When [1] or [2] is selected with the effect channel selector switch, the effect sound cannot be monitored even if the [CUE] button of the selected channel is pressed.

Using rekordbox dj

About rekordbox

This manual mainly explains the hardware operations of this unit. For detailed instructions on operating rekordbox dj and rekordbox dvs, see the rekordbox Manual.

- rekordbox
rekordbox is composite software that enables track management and DJ performances.
- rekordbox dj
The DJ performance function of rekordbox is called rekordbox dj. To be able to use this function, enter the license key shown on the license key card included with this unit.
- rekordbox dvs
The DVS function, which can be added to rekordbox dj to perform deck operations using control signals played with CDJ or a turntable, is called rekordbox dvs. To add this function, enter the license key shown on the license key card included with this unit.

Minimum operating environment

Supported operating systems CPU and required memory

| | |
|---|--|
| Mac OS X: 10.11/10.10/10.9 (latest updated) | Intel® processor Core™ i3/i5/i7, Intel® processor Core™ 2 Duo 2.0 GHz or more 4 GB or more of RAM |
| Windows: Windows 10/Windows 8.1/ Windows 7 (latest service pack) | Intel® processor Core™ i3/i5/i7, Intel® processor Core™ 2 Duo 2.0 GHz or more 4 GB or more of RAM |

Others

| | |
|---------------------|---|
| USB port | A USB 2.0 port is required to connect the computer with this unit. |
| Display resolution | Resolution of 1 280 x 768 or greater |
| Internet connection | An Internet connection is required for registering the rekordbox user account and downloading the software. |

- For information on the latest system requirements, compatibility, and supported operating systems of rekordbox, see **[System Requirements]** on the rekordbox.com site below.
<http://rekordbox.com>
- Operation is not guaranteed on all computers, even if all the required operating environment conditions indicated here are fulfilled.
- Depending on the computer's power-saving settings, etc., the CPU and hard disk may not provide sufficient processing capabilities. For notebook computers in particular, make sure the computer is in the proper conditions to provide constant high performance (for example by keeping the AC power connected) when using rekordbox.
- Use of the Internet requires a separate contract with a provider offering Internet services and payment of provider fees.
- Operating System support assumes you are using the latest point release for that version.

Viewing the "rekordbox" manual

A manual may be made of the PDF format file. To view a PDF file, installing Adobe® Reader® is required.

1 Launch a web browser on the computer and access the "rekordbox.com".

<http://rekordbox.com/>

2 Click [Support].

3 Click [Manual].

4 Click the desired language from the list.

- For information and services for "rekordbox," refer to the "rekordbox.com" above.

Installing rekordbox

If you are installing rekordbox for the first time or are upgrading from rekordbox 3 or earlier, use the following procedures.

If you have installed rekordbox 4 already, update it to the latest version.

Before installing the software

The rekordbox software is not included. Access "rekordbox.com" for the rekordbox software, and download the software.

<http://rekordbox.com/>

- The user is responsible for preparing the computer, network devices and other elements of the Internet usage environment required for a connection to the Internet.
- If you have installed rekordbox 4 already, update it to the latest version to use rekordbox dj and rekordbox dvs.

Downloading rekordbox

1 Access "rekordbox.com".

<http://rekordbox.com/en/store/>

- The site is subject to change without notice.

2 After reading the Get Started guide, click [Free To Download].



3 Read the terms of the software license agreement carefully, and then mark the [Agree] checkbox to continue.

After marking the checkbox, click **[Download]** to start downloading rekordbox.

4 Click [Download].

Downloading rekordbox will be started.

Installing rekordbox

Depending on the Operating System (OS) of your computer, procedures differ.

Do not connect the unit to your computer until the installation has completed.

- If a program is opened on your computer, close it.

Installing (Mac OS X)

- 1 Unzip the downloaded rekordbox software file.
- 2 Double-click the unzipped software file, and then start the installer.
- 3 Read the terms of the license agreement carefully, and then click [Agree] to continue.

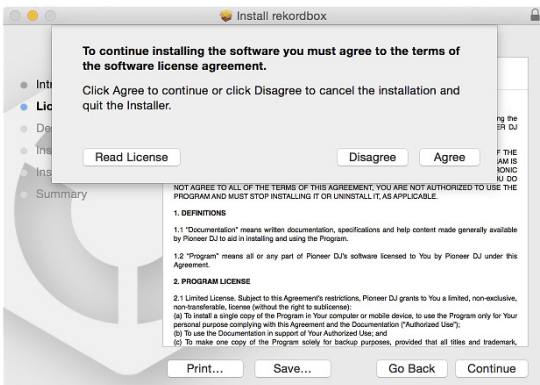

- If you do not agree to the contents of the license agreement, click [Disagree] to cancel the installation.

- 4 When the screen for completing the installation appears, click [Close] to end the installation.

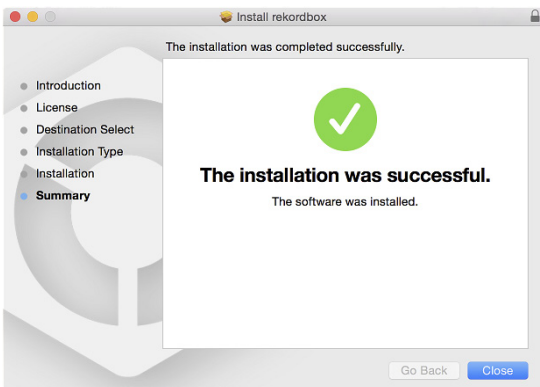

Installing (Windows)

- Log into your computer as administrator before starting the installation.

- 1 Unzip the downloaded rekordbox software file.
- 2 Double-click the unzipped software file, and then start the installer.

- 3 Read the terms of the license agreement carefully, and if you agree, select [Agree], then click [Next].

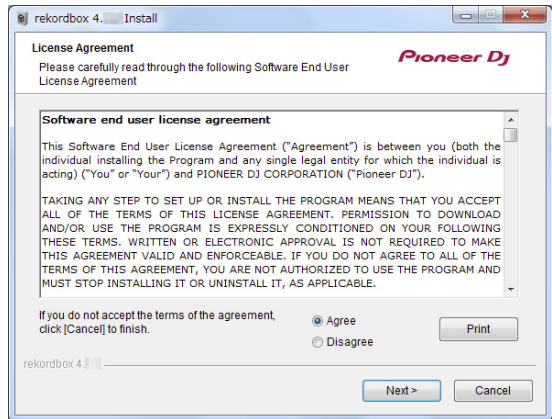

- If you do not agree to the contents of the license agreement, click [Cancel] to cancel the installation.

After specifying the destination, the installation will be started. When the installation is finished, a completion message will be displayed.

- 4 Click [Finish] to complete the installation.

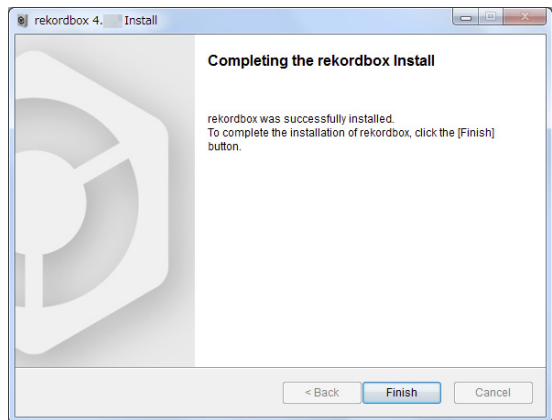

Starting rekordbox

Click the [rekordbox] icon.

For Mac OS X

In Finder, open the [Applications] folder, and then click the [rekordbox] icon in the [rekordbox 4] folder.

For Windows 10/8.1

In [Apps view], click the [rekordbox] icon.

For Windows 7

In the Windows [Start] menu, click the [rekordbox] icon under [All Programs] > [Pioneer] > [rekordbox X.X.X] > [rekordbox].

Preparing rekordbox

- This procedure is required only for the first time to start the rekordbox.

Enter the account information.

If you have an account already, enter the account information, and then click [Setup].

If you do not have an account, click [Create an account] to create an account.

- For the procedure to create an account, access "rekordbox.com", and read the rekordbox Manual on the [Support] page. <http://rekordbox.com/>

Choose the method you will use.

Click [DJ performance] icon.

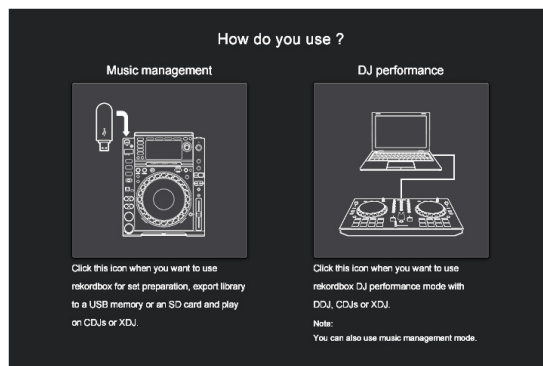

Enter the license key to activate rekordbox dj.

Enter the license keys which are shown on the license key card included with this unit, then follow the screen instructions to activate rekordbox dj and rekordbox dvs.

- For the procedure to activate rekordbox dj, access "rekordbox.com", and read the rekordbox Manual on the [Support] page. <http://rekordbox.com/>

Installing the driver software

This audio driver software is for output sound of the computer from this unit.

1 Disconnect the USB cable connected between the unit and computer.

2 On the [Audio Driver Install] screen, select [DJM-450] from the pull down menu, and then click [Install].

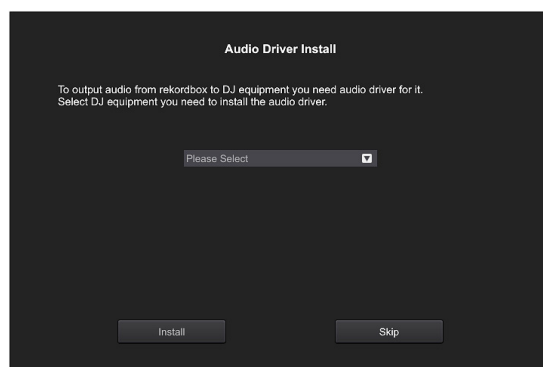

- If you click [Skip], the audio driver is not installed. To install the audio driver later, select the following file after clicking [Preferences] > [Audio] > [Audio] > [Driver] on rekordbox dj. For Mac OS X: DJM-450_M_X.X.X.dmg For Windows: DJM-450_VerX.X.X.exe

Installing (Mac OS X)

Do not connect the unit and computer until the installing is completed.

- If a program is opened on your computer, close it.

1 Read the instruction screen, and then click [Continue].

2 Read the terms of the software license agreement carefully, and then click [Continue].

If you do not agree to the contents of the license agreement, click [Disagree] to cancel the installation.

3 Follow the instruction screens to install the software.

4 Connect the unit and your computer with using the USB cable.

Installing (Windows)

Do not connect the unit and computer until the installing is completed.

- Logon into your computer as administrator before starting the installation.
- If a program is opened on your computer, close it.

1 Read the instruction screen, and then click [Continue].

2 Read the terms of the software license agreement carefully, mark the [I agree] checkbox, and then click [OK].

If you do not agree to the contents of the license agreement, click [Cancel] to cancel the installation.

3 Follow the instruction screens to install the software.

If the [Windows Security] screen is displayed during the installation, click [Install this driver software anyway] to continue.

When the installation is finished, a completion message will be displayed.

4 Connect the unit and your computer with using the USB cable.

Reporting your rekordbox usage statistics

If you agree to your rekordbox usage statistics being sent to the manufactures, to improve rekordbox quality and specifications, click [Yes] on the following screen. If you do not agree, click [No].

Do you agree to send information on error log and debug information to improve the quality and usability of rekordbox ?
This setting is always changeable in [Preferences].

[Privacy Policy](#)

Yes

No

Adding audio tracks into [Collection]

The [Collection] screen contains a list of audio track files managed by rekordbox.

Register audio tracks on your computer to rekordbox, and analyze them so they can be used on rekordbox.

1 Click [Collection] on the tree view.

A audio track list registered on [Collection] is displayed.

2 Open Finder or Windows Explorer, and then drag & drop audio track files or folders with audio track files into the audio track list.

Audio track files are added into [Collection], and then analyzing of waveform information for audio track files starts.

Wait until analyzing of all audio track files is completed.

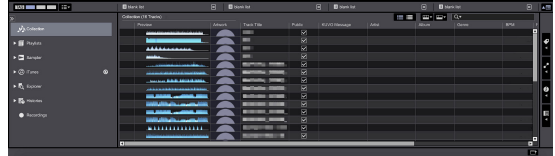

Using the DVS system

Digital music files on a computer can be played by connecting the computer ^[1] and an analog player (or DJ player) to this unit and then playing a control disc ^[2] with the analog player (or DJ player).

[1] Install rekordbox dj on your computer beforehand.

[2] A special record or CD containing the signals necessary for operating digital music files.

About the settings of rekordbox dj

For the settings of rekordbox dj to use the DVS system, refer to *rekordbox dvs Setup Guide* on the following web site.

<https://rekordbox.com/en/support/manual.php>

Setting the control signals

Set the control signals depending on whether your device is an analog player or DJ player.

Set the control signals as described below.

1 Connect this unit to the computer with a USB cable.

2 Launching rekordbox

3 Click [Preferences] of rekordbox (PERFORMANCE mode) > [Input channel] > [Settings Utility].

The setting utility of this unit starts.

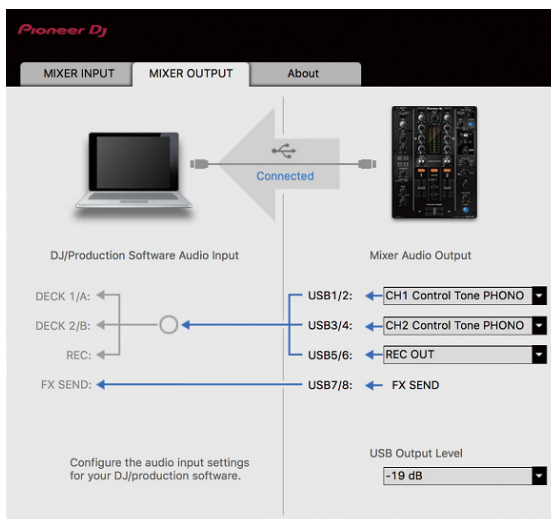

4 Select the [MIXER OUTPUT] tab in the setting utility, and then select as shown below from the [Mixer Audio Output] pull-down menu corresponding to the connected channel.

When analog player: [CH* Control Tone PHONO]

When DJ player: [CH* Control Tone LINE]

Using an application other than rekordbox dj

Installing the driver software

This driver software is a proprietary program for inputting and outputting audio signals from the computer. To use this unit connected to a computer on which a Mac OS or Windows is installed, install the driver software on the computer beforehand.

Software end user license agreement

This Software End User License Agreement ("Agreement") is between you (both the individual installing the Program and any single legal entity for which the individual is acting) ("You" or "Your") and Pioneer DJ Corporation ("Pioneer DJ").

TAKING ANY STEP TO SET UP OR INSTALL THE PROGRAM MEANS THAT YOU ACCEPT ALL OF THE TERMS OF THIS LICENSE AGREEMENT. PERMISSION TO DOWNLOAD AND/OR USE THE PROGRAM IS EXPRESSLY CONDITIONED ON YOUR FOLLOWING THESE TERMS. WRITTEN OR ELECTRONIC APPROVAL IS NOT REQUIRED TO MAKE THIS AGREEMENT VALID AND ENFORCEABLE. IF YOU DO NOT AGREE TO ALL OF THE TERMS OF THIS AGREEMENT, YOU ARE NOT AUTHORIZED TO USE THE PROGRAM AND MUST STOP INSTALLING IT OR UNINSTALL IT, AS APPLICABLE.

1 DEFINITIONS

- 1 "Documentation" means written documentation, specifications and help content made generally available by Pioneer DJ to aid in installing and using the Program.
- 2 "Program" means all or any part of Pioneer DJ's software licensed to You by Pioneer DJ under this Agreement.

2 PROGRAM LICENSE

- 1 Limited License. Subject to this Agreement's restrictions, Pioneer DJ grants to You a limited, non-exclusive, non-transferable, license (without the right to sublicense):
 - a To install a single copy of the Program in Your computer or mobile device, to use the Program only for Your personal purpose complying with this Agreement and the Documentation ("Authorized Use");
 - b To use the Documentation in support of Your Authorized Use; and
 - c To make one copy of the Program solely for backup purposes, provided that all titles and trademark, copyright and restricted rights notices are reproduced on the copy.
- 2 Restrictions. You will not copy or use the Program or Documentation except as expressly permitted by this Agreement. You will not transfer, sublicense, rent, lease or lend the Program, or use it for third-party training, commercial time-sharing or service bureau use. You will not Yourself or through any third party modify, reverse engineer, disassemble or decompile the Program, except to the extent expressly permitted by applicable law, and then only after You have notified Pioneer DJ in writing of Your intended activities.
- 3 Ownership. Pioneer DJ or its licensor retains all right, title and interest in and to all patent, copyright, trademark, trade secret and other intellectual property rights in the Program and Documentation, and any derivative works thereof. You do not acquire any other rights, express or implied, beyond the limited license set forth in this Agreement.
- 4 No Support. Pioneer DJ has no obligation to provide support, maintenance, upgrades, modifications or new releases for the Program or Documentation under this Agreement.

3 WARRANTY DISCLAIMER

THE PROGRAM AND DOCUMENTATION ARE PROVIDED "AS IS" WITHOUT ANY REPRESENTATIONS OR WARRANTIES, AND YOU

AGREE TO USE THEM AT YOUR SOLE RISK. TO THE FULLEST EXTENT PERMISSIBLE BY LAW, PIONEER DJ EXPRESSLY DISCLAIMS ALL WARRANTIES OF ANY KIND WITH RESPECT TO THE PROGRAM AND DOCUMENTATION, WHETHER EXPRESS, IMPLIED, STATUTORY, OR ARISING OUT OF COURSE OF PERFORMANCE, COURSE OF DEALING OR USAGE OF TRADE, INCLUDING ANY WARRANTIES OF MERCHANTABILITY, FITNESS FOR A PARTICULAR PURPOSE, SATISFACTORY QUALITY, ACCURACY, TITLE OR NON-INFRINGEMENT.

4 EXPORT CONTROL AND COMPLIANCE WITH LAWS AND REGULATIONS

You may not use or otherwise export or re-export the Program except as authorized by United States law and the laws of the jurisdiction in which the Program was obtained. In particular, but without limitation, the Program may not be exported or re-exported (a) into any U.S.-embargoed countries or (b) to anyone on the U.S. Treasury Department's Specially Designated Nationals List or the U.S. Department of Commerce Denied Persons List or Entity List. By using the Program, you represent and warrant that you are not located in any such country or on any such list. You also agree that you will not use the Program for any purposes prohibited by United States law, including, without limitation, the development, design, manufacture, or production of nuclear, missile, or chemical or biological weapons.

5 U.S. GOVERNMENT RESTRICTED RIGHTS

The Program and Documentations are "commercial computer software" and "commercial computer software documentation" as those terms are defined in 48 C.F.R. §252.227-7014 (a) (1) (2007) and 252.227-7014 (a) (5) (2007). The U.S. Government's rights with respect to the Program and Documentations are limited by this license pursuant to 48 C.F.R. §12.212 (Computer software) (1995) and 48 C.F.R. §12.211 (Technical data) (1995) and/or 48 C.F.R. §227.7202-3, as applicable. As such, the Program and Documentations are being licensed to the U.S. Government end users: (a) only as "commercial items" as that term is defined in 48 C.F.R. §2.101 generally and as incorporated in DFAR 212.102; and (b) with only those limited rights as are granted to the public pursuant to this license. Under no circumstance will the U.S. Government or its end users be granted any greater rights than we grant to other users, as provided for in this license. Manufacturer is Pioneer DJ Corporation, 1-1 Shin-Ogura, Saiwai-ku, Kawasaki-shi, Kanagawa, 212-0031 Japan

6 DAMAGES AND REMEDIES FOR BREACH

You agree that any breach of this Agreement's restrictions would cause Pioneer DJ irreparable harm for which money damages alone would be inadequate. In addition to damages and any other remedies to which Pioneer DJ may be entitled, You agree that Pioneer DJ may seek injunctive relief to prevent the actual, threatened or continued breach of this Agreement.

7 TERMINATION

Pioneer DJ may terminate this Agreement at any time upon Your breach of any provision. If this Agreement is terminated, You will stop using the Program, permanently delete it from your computer or mobile device where it resides, and destroy all copies of the Program and Documentation in Your possession, confirming to Pioneer DJ in writing that You have done so. Sections 2,2, 2,3, 2,4, 3, 4, 5, 6, 7 and 8 will continue in effect after this Agreement's termination.

8 GENERAL TERMS

- 1 Limitation of Liability. In no event will Pioneer DJ or its subsidiaries be liable in connection with this Agreement or its subject matter, under any theory of liability, for any indirect, incidental, special, consequential or punitive damages, or damages for lost profits, revenue, business, savings, data, use, or cost of substitute procurement, even if advised of the possibility of such damages or if such damages are foreseeable. In no event

will Pioneer DJ's liability for all damages exceed the amounts actually paid by You to Pioneer DJ or its subsidiaries for the Program. The parties acknowledge that the liability limits and risk allocation in this Agreement are reflected in the Program price and are essential elements of the bargain between the parties, without which Pioneer DJ would not have provided the Program or entered into this Agreement.

- 2 The limitations or exclusions of warranties and liability contained in this Agreement do not affect or prejudice Your statutory rights as consumer and shall apply to You only to the extent such limitations or exclusions are permitted under the laws of the jurisdiction where You are located.
- 3 Severability and Waiver. If any provision of this Agreement is held to be illegal, invalid or otherwise unenforceable, that provision will be enforced to the extent possible or, if incapable of enforcement, deemed to be severed and deleted from this Agreement, and the remainder will continue in full force and effect. The waiver by either party of any default or breach of this Agreement will not waive any other or subsequent default or breach.
- 4 No Assignment. You may not assign, sell, transfer, delegate or otherwise dispose of this Agreement or any rights or obligations under it, whether voluntarily or involuntarily, by operation of law or otherwise, without Pioneer DJ's prior written consent. Any purported assignment, transfer or delegation by You will be null and void. Subject to the foregoing, this Agreement will be binding upon and will inure to the benefit of the parties and their respective successors and assigns.
- 5 Entire Agreement. This Agreement constitutes the entire agreement between the parties and supersedes all prior or contemporaneous agreements or representations, whether written or oral, concerning its subject matter. This Agreement may not be modified or amended without Pioneer DJ's prior and express written consent, and no other act, document, usage or custom will be deemed to amend or modify this Agreement.
- 6 You agree that this Agreement shall be governed and construed by and under the laws of Japan.

Cautions on Installation

- Before installing the driver software, be sure to turn off the power of this unit and disconnect the USB cable from both this unit and your computer.
- If you connect this unit to your computer without installing the driver software first, an error may occur on your computer depending on the system environment.
- If you have discontinued the installation process in progress, step through the installation process again from the beginning according to the following procedure.
- Read *Software end user license agreement* carefully before installing this unit's proprietary driver software.
- Before installing the driver software, terminate all other programs running on your computer.
- The driver software is compatible with the following OSs.

Supported operating systems

| | | |
|---|----------------|---|
| Mac OS X: 10.11, 10.10, 10.9, 10.8 (latest update) | | ✓ |
| Windows® 10 (latest service pack) | 32-bit version | ✓ |
| | 64-bit version | ✓ |
| Windows® 8/8.1 (latest service pack) | 32-bit version | ✓ |
| | 64-bit version | ✓ |
| Windows Pro® 8/8.1 (latest service pack) | 32-bit version | ✓ |
| | 64-bit version | ✓ |
| Windows® 7 Home Premium/Professional/Ultimate (latest service pack) | 32-bit version | ✓ |
| | 64-bit version | ✓ |

Checking the latest information on the driver software

For the latest information on this unit's dedicated driver software, see the Pioneer DJ site below.
<http://www.pioneerdj.com/>

Obtaining the driver software

1 Launch a web browser on the computer and access the Pioneer DJ site below.

<http://www.pioneerdj.com/>

2 Click the [Support] icon.

3 Click the [FIND SOFTWARE & FIRMWARE UPDATES] icon.

4 Click the [DJM-450] icon in the [DJ MIXER] category.

5 After clicking [Drivers], download the latest driver software from the download page.

- Download the driver for either Windows or Mac from the download page.

Installing the driver software

Depending on the Operating System (OS) of your computer, procedures differ.

Do not connect the unit to your computer until the installation has completed.

- If a program is opened on your computer, close it.

Installation procedure (Mac OS X)

Read *Cautions on Installation* carefully before installing the driver software.

- To install or uninstall the driver software, you need to be authorized by the administrator of your computer. Have the name and password of the administrator of your computer ready in advance.

1 Double-click the file for Mac (DJM-450_M_X.X.X.dmg) downloaded in *Obtaining the driver software*.

2 Double-click [DJM-450_AudioDriver.pkg].

The driver software installation screen appears.

3 Check the details on the screen and click [Continue].

4 When the end user license agreement appears, read *Software end user license agreement* carefully, then click [Continue].

5 If you consent to the provisions of the *Software end user license agreement*, click [Agree].

If you do not consent to the provisions of the *Software end user license agreement*, click [Disagree] and stop installation.

6 Proceed with installation according to the instructions on the screen.

- Click [Cancel] to cancel installation after it has started.

Installation Procedure (Windows)

Read *Cautions on Installation* carefully before installing the driver software.

- To install or uninstall the driver software, you need to be authorized by the administrator of your computer. Log on as the administrator of your computer before proceeding with the installation.

1 Double-click the file for Windows (DJM-450_X.XXX.exe) downloaded in *Obtaining the driver software*.

The driver software installation screen appears.

2 Carefully read the *Software end user license agreement* and if you consent to the provisions, put a check mark in [I agree.] and click [OK].

If you do not consent to the provisions of the *Software end user license agreement*, click [Cancel] and stop installation.

3 Proceed with installation according to the instructions on the screen.

If [Windows Security] appears on the screen while the installation is in progress, click [Install this driver software anyway] and continue with the installation.

- When the installation program is completed, a completion message appears.

Changing the settings

Setting preferences

*: Default setting

| Setting items | Detail setting items | Setting value | Descriptions |
|-----------------|----------------------|----------------------|---|
| MASTER OUT | PEAK LIMITER | OFF, ON* | This decreases digital clips. |
| | ATT. | -12 dB, -6 dB, 0 dB* | Set the decreasing level of sound output from the [MASTER1] and [MASTER2] output terminals. |
| | MONO/STEREO | MONO, STEREO* | Set to monaural or stereo for the master output sound. |
| MIDI | CH | 1* to 16 | Set the MIDI channel. |
| | BUTTON TYPE | TOGGLE*, TRIGGER | Set the MIDI signal transmission mode to [TOGGLE] or [TRIGGER]. |
| OLED BRIGHTNESS | — | 1 to 3* | Set the display's brightness. |
| PC UTILITY | — | OFF*, ON | Set whether or not to launch the computer's setting utility software automatically when a USB cable is connected. |
| AUTO STANDBY | — | OFF, ON* | Turn the auto standby function on and off. |
| FACTORY RESET | — | CANCEL/RESET | All settings are set to their defaults. |

Change Procedure

1 While pressing [SEND/RETURN ON/OFF] button, press the [POWER] button.

The [UTILITY] screen is displayed.

2 Press the [BEAT ◀, ▶] button.

Select the setting item.

3 Press the [TAP] button.

The ▲ mark is moved to the detail setting.

4 Press the [BEAT ◀, ▶] button.

Select a detail setting.

5 Press the [TAP] button.

The detail settings are set, then the ▲ mark is moved to the setting item.

- To return to the previous screen without changing the settings, press the [TAP] button.

6 Press the [SEND/RETURN ON/OFF] button.

The [UTILITY] screen closes.

About the auto standby function

When [AUTO STANDBY] is set to [ON], the unit automatically enters the standby mode if 10 hours elapses with all of the following conditions met.

- That none of this unit's buttons or controls are operated.
- That no audio signal is input to each channel of this unit.
- In the standby mode, the [WAKE UP] indicator is lit.
- When the [TAP] button is pressed, the standby mode is canceled.
- This unit is shipped with the auto standby function turned on. If you do not want to use the auto standby function, set [AUTO STANDBY] to [OFF].

About the setting utility software

The setting utility can be used to make the checks and settings described below.

- Check the status of this unit's input selector switches.
- Set the audio data output from this unit to the computer.
- Adjust the buffer size (when using Windows ASIO).
- Check the version of the firmware and driver software.

Displaying the setting utility

For Mac OS X

Click [Macintosh HD] icon > [Application] > [Pioneer] > [DJM-450] > [DJM-450 Settings Utility].

For Windows 10/8.1

In [Apps view], click the [DJM-450 Settings Utility] icon.

For Windows 7

Click [Start] menu > [All Programs] > [Pioneer] > [DJM-450] > [DJM-450 Settings Utility].

Checking the status of this unit's input selector switches

Display the setting utility before starting.

Click the [MIXER INPUT] tab.

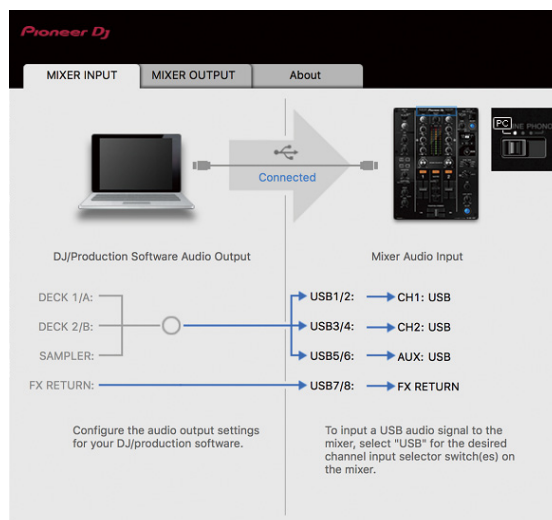

- [FX RETURN] can be used with compatible software.

Setting the audio data output from this unit to the computer

Display the setting utility before starting.

1 Click the [MIXER OUTPUT] tab.

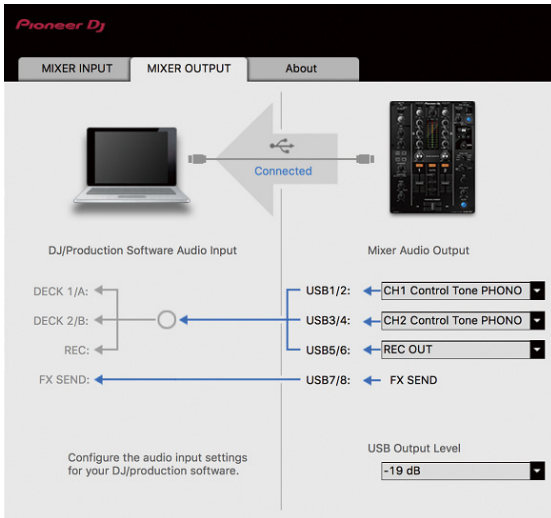

2 Click the [Mixer Audio Output] pull-down menu.

Select and set the audio data to be output to the computer from the flow of audio signals inside this unit.

- For [Mixer Audio Output] pull-down menu list, see page 24.

3 Click the [USB Output Level] pull-down menu.

Adjust the volume of the audio data output from this unit.

- The [USB Output Level] setting is applied equally to all audio data. However, when [T] on the table at step 2 is selected, the audio data is output with the same volume at which it is input to this unit.
- If not enough volume can be achieved with the DJ software's volume adjustment alone, change the [USB Output Level] setting to adjust the volume of the audio data output from this unit. Note that the sound will be distorted if the volume is raised too high.
- [FX SEND] and [Control Tone] can be used with supported software.

Adjusting the buffer size (when using Windows ASIO)

If an application using this unit as the default audio device (DJ software, etc.) is running, quit that application before adjusting the buffer size.

Display the setting utility before starting.

Click the [ASIO] tab.

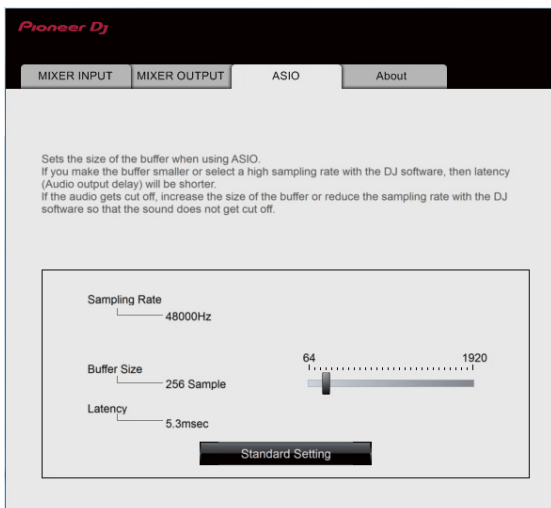

- If the buffer size is made large, drops in audio data (breaks in the sound) occur less easily, but the time lag due to the delay in the transfer of the audio data (latency) increases.

Checking the version of the firmware and driver software

Display the setting utility before starting.

Click the [About] tab.

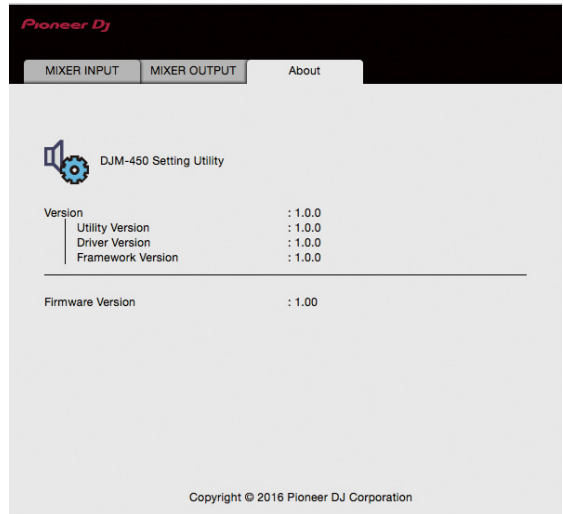

Checking the latest information on the driver software

For the latest information on this unit's dedicated driver software, see the Pioneer DJ site below.

<http://pioneerdj.com/support/>

- Operation cannot be guaranteed when multiple units of this mixer are connected to a single computer.

[Mixer Audio Output] pulldown menu list

| CH1 (USB1/2) | CH2 (USB3/4) | CH3 (USB5/6) | CH4 (USB7/8) |
|---------------------------------------|---------------------------------------|-------------------------------|------------------------|
| CH1 Control Tone PHONO ^[1] | CH2 Control Tone PHONO ^[1] | REC OUT ^[2] | FX SEND ^[3] |
| CH1 Control Tone LINE ^[1] | CH2 Control Tone LINE ^[1] | Post CH1 Fader ^[2] | — |
| Post CH1 Fader | Post CH2 Fader | Post CH2 Fader | — |
| CROSS FADER A ^[2] | CROSS FADER A ^[2] | CROSS FADER A ^[2] | — |
| CROSS FADER B ^[2] | CROSS FADER B ^[2] | CROSS FADER B ^[2] | — |
| MIC | MIC | MIC | — |
| AUX | AUX | AUX | — |
| REC OUT | REC OUT | — | — |

^[1] Can be used with compatible software. The audio data is output with the same volume at which it is input to this unit, regardless of the [USB Output Level] setting.

^[2] When using for applications other than recording, pay attention to the DJ application's settings so that no audio loops are generated. If audio loops are generated, sound may be input or output at unintended volumes.

^[3] Can be used with compatible software.

Additional information

Troubleshooting

- If you think that there is something wrong with this unit, check the items below, and check [FAQ] for [DJM-450] on the Pioneer DJ site. <http://pioneerdj.com/support/>
Also, check the connected devices. If the problem cannot be resolved, ask your nearest Pioneer authorized service center or your dealer to carry out repair work.
- This unit may not operate properly due to static electricity or other external influences. In such cases, normal operation may be restored by unplugging the power cord then plugging it back in.

| Problem | Check | Remedy |
|--|--|---|
| There is no sound or the volume is too low. | Is the input selector switch set to the proper position? | Set the input selector switch to the input source for the channel. (page 9) |
| | Are the connection cables properly connected? | Connect the connection cables properly. (page 7) |
| | Are the terminals and plugs dirty? | Clean the terminals and plugs before making connections. |
| | Is [ATT.] of [MASTER OUT] set to [-6 dB], etc.? | Set [ATT.] of [MASTER OUT] on the [UTILITY] screen. (page 22) |
| Sound is distorted. | Is the sound level output from the [MASTER] channel appropriately set? | Adjust the [MASTER LEVEL] control so that the master channel level indicator lights at around [0 dB] at the peak level. (page 9) |
| | Is the level of audio input to each channel properly set? | Set [ATT.] of [MASTER OUT] on the [UTILITY] screen to [-6 dB] or [-12 dB]. (page 22) Adjust the [TRIM] control so that the channel level indicator lights at about [0 dB] at the peak level. |
| Cross fade does not work. | Is the [CROSS F. CURVE] selector switch set properly? | If [THRU] is selected, cross fader does not work. Set the [CROSS F. CURVE] selector switch properly. (page 9) |
| BEAT FX does not work. | Is the effect channel selector switch set to the proper position? | Turn the effect channel selector switch to select the channel to which you want to apply the effect. |
| SOUND COLOR FX does not work. | Is the [COLOR] control set to an appropriate position? | Turn the [COLOR] control clockwise or counterclockwise. (page 10) |
| SEND/RETURN on the mobile device does not work. | Is the effect channel selector switch set to the proper position? | Turn the effect channel selector switch to select the channel to which you want to apply the effect. |
| | Is the [SEND/RETURN ON/OFF] button set to [ON]? | Press the [SEND/RETURN ON/OFF] button to turn on the SEND/RETURN function. (page 10) |
| | Is the mobile device connected to the mobile device connection terminal correctly? | Connect the mobile device to the mobile device connection terminal and launch a compatible application. |
| Sound on SEND/RETURN is distorted. | Is the [RETURN TYPE (AUX, INSERT)] selector switch set correctly? | Set the [RETURN TYPE (AUX, INSERT)] switch to the correct position. |
| | Is the external effector's audio output level set to an appropriate level? | Adjust the external effector's audio output level. |
| Tempo (BPM) cannot be measured or measurement value of tempo (BPM) is implausible. | Is the audio input level too high or too low? | Adjust the [TRIM] control so that the channel level indicator lights at about [0 dB] at the peak level. (page 9) |
| | | For some tracks, it may not be possible to measure the tempo (BPM). Use the [TAP] button to input the tempo manually. |
| Measured tempo (BPM) differs from tempo indicated on CD. | — | The values may differ slightly due to the different ways in which the BPM is measured. |
| MIDI control does not work. | Are the MIDI settings properly set? | To operate software with this unit, this unit's MIDI messages must be assigned to the software you are using. For the assignment method, see your software's operating instructions. |
| | Is the driver software properly installed on your computer? | Install the driver software. If it is already installed, reinstall it. (page 19) |
| | Are the MIDI settings properly set? | To operate software with this unit, this unit's MIDI messages must be assigned to the software you are using. For the assignment method, see your software's operating instructions. |
| This unit is not recognized after it has been connected to a computer. | Are the MIDI settings properly set? | To operate software with this unit, this unit's MIDI messages must be assigned to the software you are using. For the assignment method, see your software's operating instructions. |
| | Are the audio output device settings properly set? | Select this unit with the audio output device settings. For instructions on making settings for your application, see your application's operating instructions. |
| | Is the input selector switch set to the proper position? | Set the input selector switch to the [] position. (page 9) |
| Sound of a computer cannot be output from this unit. | Have you connected an analog player with a built-in phono equalizer? | Connect the analog player with built-in phono equalizer to the [LINE] input terminals. (page 7) |
| | Is an audio interface for computers connected between the analog player and this unit? | If the analog player with built-in phono equalizer has a PHONO/LINE selector switch, set it to PHONO. If the output of the audio interface for computers is line level, connect it to the [LINE] input terminals. (page 7) |
| | Is an audio interface for computers connected between the analog player and this unit? | If the analog player has a PHONO/LINE selector switch, set it to PHONO. |

Block Diagram

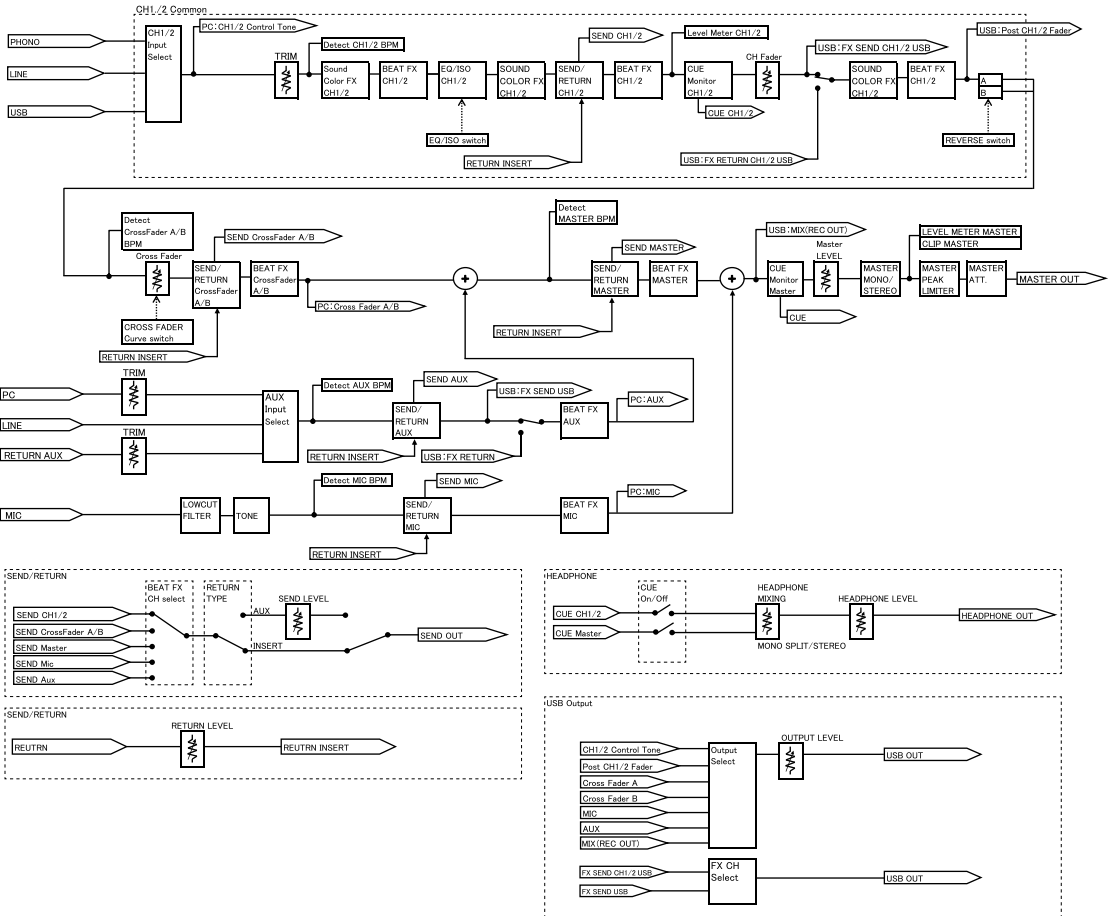
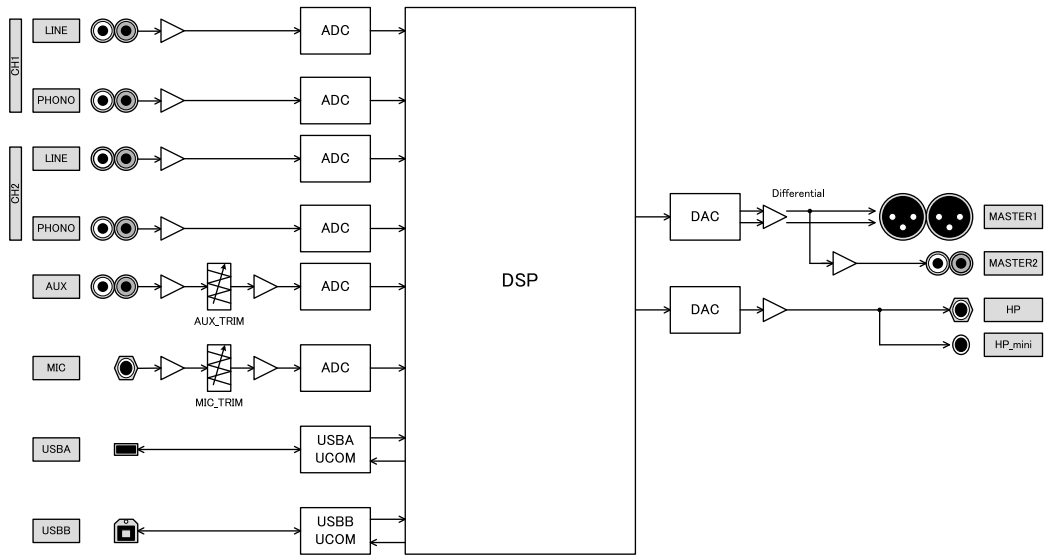

About trademarks and registered trademarks

- Pioneer DJ is a trademark of PIONEER CORPORATION, and is used under license. rekordbox is a trademark or registered trademark of the Pioneer DJ Corporation.
- Microsoft and Windows are either registered trademarks or trademarks of Microsoft Corporation in the United States and/or other countries.
- Mac OS, iTunes, and Finder are trademarks of Apple Inc., registered in the U.S. and other countries.
- Intel and Intel Core are trademarks of Intel Corporation in the U.S. and/or other countries.
- ASIO is a trademark of Steinberg Media Technologies GmbH.

The names of companies and products mentioned herein are trademarks or registered trademarks of their respective owners.

- The specifications and design of this product are subject to change without notice.

© 2016 Pioneer DJ Corporation. All rights reserved.
<DRI1406-A>

Cautions on copyrights

rekordbox restricts playback and duplication of copyright-protected music contents.

- When coded data, etc., for protecting the copyright is embedded in the music contents, it may not be possible to operate the program normally.
- When rekordbox detects that coded data, etc., for protecting the copyright is embedded in the music contents, processing (playback, reading, etc.) may stop.

Recordings you have made are for your personal enjoyment and according to copyright laws may not be used without the consent of the copyright holder.

- Music recorded from CDs, etc., is protected by the copyright laws of individual countries and by international treaties. It is the full responsibility of the person who has recorded the music to ensure that it is used legally.
- When handling music downloaded from the Internet, etc., it is the full responsibility of the person who has downloaded the music to ensure that it is used in accordance with the contract concluded with the download site.

Software license notice

The licenses for the open source software used on this player are shown below. For accuracy purposes, here we have included the original texts (in English).

Copyright © 2010 Texas Instruments Incorporated - <http://www.ti.com/>
Redistribution and use in source and binary forms, with or without modification, are permitted provided that the following conditions are met:

Redistributions of source code must retain the above copyright notice, this list of conditions and the following disclaimer.

Redistributions in binary form must reproduce the above copyright notice, this list of conditions and the following disclaimer in the documentation and/or other materials provided with the distribution.

Neither the name of Texas Instruments Incorporated nor the names of its contributors may be used to endorse or promote products derived from this software without specific prior written permission.

THIS SOFTWARE IS PROVIDED BY THE COPYRIGHT HOLDERS AND CONTRIBUTORS «AS IS» AND ANY EXPRESS OR IMPLIED WARRANTIES, INCLUDING, BUT NOT LIMITED TO, THE IMPLIED WARRANTIES OF MERCHANTABILITY AND FITNESS FOR A PARTICULAR PURPOSE ARE DISCLAIMED. IN NO EVENT SHALL THE COPYRIGHT OWNER OR CONTRIBUTORS BE LIABLE FOR ANY DIRECT, INDIRECT, INCIDENTAL, SPECIAL, EXEMPLARY, OR CONSEQUENTIAL DAMAGES (INCLUDING, BUT NOT LIMITED TO, PROCUREMENT OF SUBSTITUTE GOODS OR SERVICES; LOSS OF USE, DATA, OR PROFITS; OR BUSINESS INTERRUPTION) HOWEVER CAUSED AND ON ANY THEORY OF LIABILITY, WHETHER IN CONTRACT, STRICT LIABILITY, OR TORT (INCLUDING NEGLIGENCE OR OTHERWISE) ARISING IN ANY WAY OUT OF THE USE OF THIS SOFTWARE, EVEN IF ADVISED OF THE POSSIBILITY OF SUCH DAMAGE.