

Operating Instructions

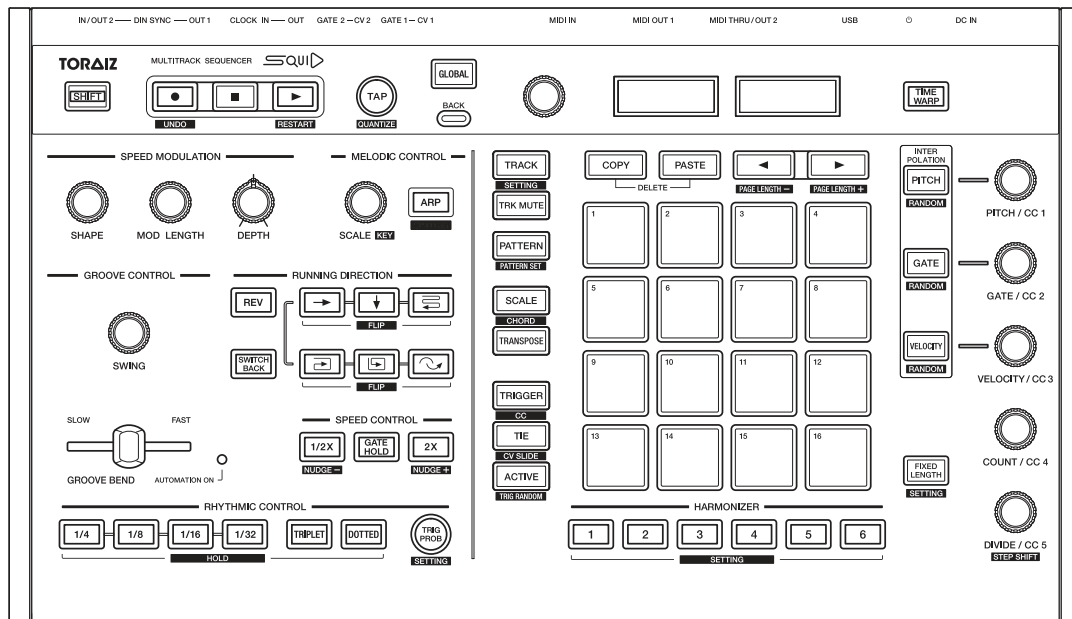

Multitrack Sequencer

SQUID

pioneerdj.com/support/

For FAQs and other support information for this product, visit the above site.

TORAIZ

How to read this manual

Thank you for purchasing this Pioneer DJ product.

Be sure to read this manual and the “Operating Instructions (Quick Start Guide)” included with this unit. Both documents include important information that you should understand before using this product.

In particular, be sure to read “IMPORTANT SAFETY INSTRUCTIONS.”

- In this manual, the names of buttons, knobs and terminals indicated on the product, and names of menus, etc. on the unit displays, are indicated within square brackets ([]). (e.g. **[GLOBAL]** button, **[CLOCK OUT]** terminal, **[Save As]**)
- Please note that the unit displays and their specifications described in this manual as well as the external appearance and specifications of the hardware are currently under development and may differ from the final specifications.
- Please note that depending on the operating system version, web browser settings, etc., operation may differ from the procedures described in this manual.

Contents

How to read this manual	2
Before starting.....	6
Features.....	6
Auto power off function	7
Part names and functions	8
Control panel	8
Rear panel	16
Connections.....	18
Connecting inputs and outputs	19
The data structure of the unit.....	21
Basic Operation.....	22
Project management.....	22
Transport	26
Step edit section.....	29
Switching the 16-pad mode	29
TRACK mode.....	31
TRACK MUTE mode	33
PATTERN mode	34
PATTERN SET mode	37
SCALE mode	39
CHORD mode.....	44
TRANSPOSE mode.....	46
TRIGGER mode	47
CC (Control Change) mode	61
TIE mode	64

CV SLIDE mode	65
ACTIVE mode.....	66
INTERPOLATION.....	67
RANDOMIZER.....	70
HARMONIZER.....	71
COPY/PASTE.....	73
DELETE.....	75
STEP SHIFT	78
STEP JUMP.....	78
FIXED LENGTH.....	79
Phrase arrangement section.....	80
SPEED MODULATION function.....	80
MELODIC CONTROL function	86
GROOVE CONTROL function.....	92
RUNNING DIRECTION function.....	95
SPEED CONTROL function	99
RHYTHMIC CONTROL function.....	101
Global section.....	104
UNDO	104
TIME WARP	106
Changing the settings.....	108
GLOBAL settings.....	108
QUANTIZE settings	140
ARPEGGIATOR settings.....	142
TRIG PROB (Trigger Probability) settings	144
TRACK settings	145
HARMONIZER settings	148
FIXED LENGTH setting	151

Connecting to external equipment	152
Connecting the unit to an external MIDI device or a PC/Mac to play	152
Synchronizing the unit to external MIDI devices or a PC/Mac	156
Connecting the unit to an external CV/GATE compatible device to play	158
Synchronizing the unit and an external DIN SYNC compatible device to play	160
Synchronizing the unit with an external CLOCK compatible device to play	165
Signal conversion function	169
Additional information	171
Troubleshooting	171
About trademarks and registered trademarks	175
Specifications	176

Before starting

Features

The SQUID is a standalone multitrack sequencer that can connect various music production equipment and produce phrases successively. Phrases can be sequenced quickly using the step parameter knobs which work independently for each parameter and the sequence functions such as HARMONIZER and INTERPOLATION.

Constantly get inspired by phrases created by the unit. You can add different arrangements to the sequence and experiment with the user interface using numerous arrangement functions such as RUNNING DIRECTION, GROOVE BEND and SPEED MODULATION.

This inspiring and expressive musical tool is compatible with many types of music production systems. It features terminals for USB and MIDI as well as CV/GATE OUT and DIN SYNC-which can control not only modular synthesizers but also vintage electronic musical instruments.

Auto power off function

This unit comes with an auto power off function, which is enabled as the default setting. The power turns off automatically when there is no signal input, output or operation for approximately 4 hours.

To turn on the power once the unit has turned off automatically, press the [⏻] button on the rear panel to release it to the off position (■), and then press in the [⏻] button again (■).

To disable the auto power off function, press the [GLOBAL] button to display the GLOBAL menu. Then, turn the rotary selector to switch the [Auto Power Off] setting to [Disable].

Notes

- Unsaved data will be lost if the unit is powered off automatically. Be sure to save important data such as edited project data.
- The auto power off function may not turn off the unit in certain modes of operation. Therefore, always be sure to turn off the power manually after use.

Part names and functions

Control panel

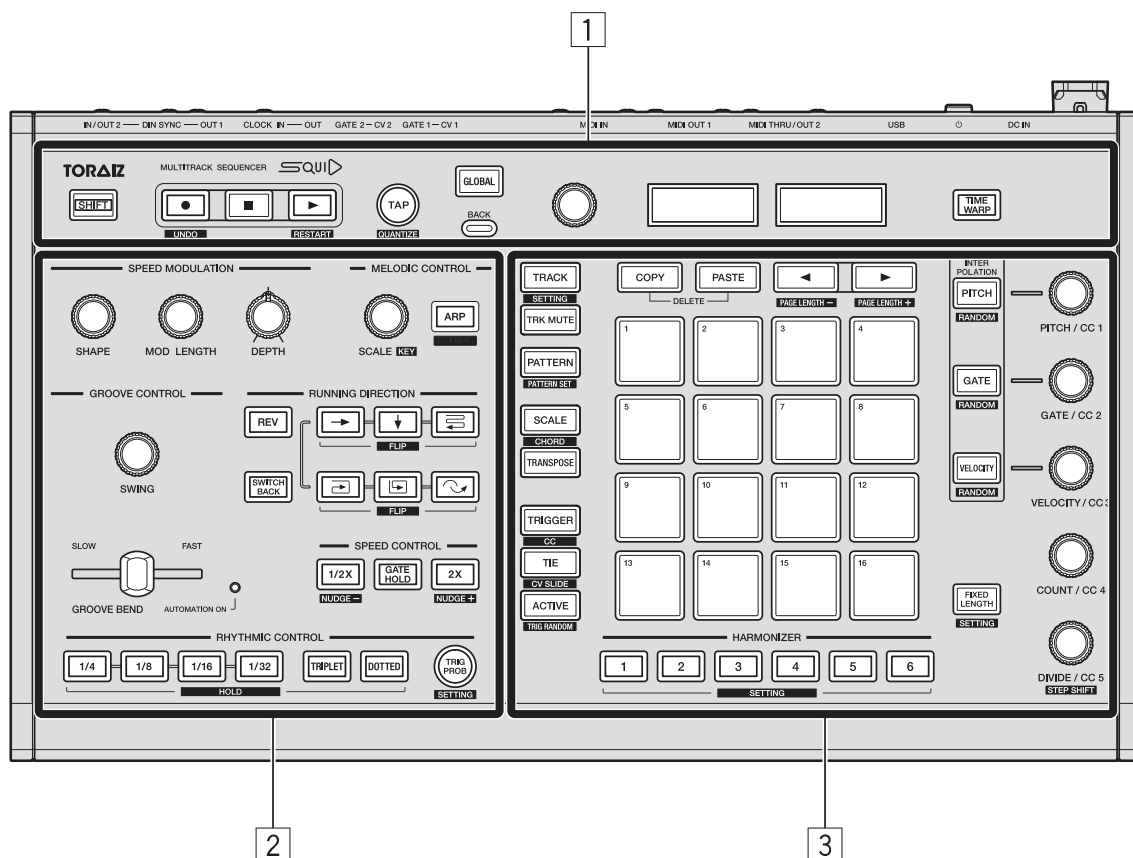

1 Global section

2 Phrase arrangement section

3 Step edit section

Global section

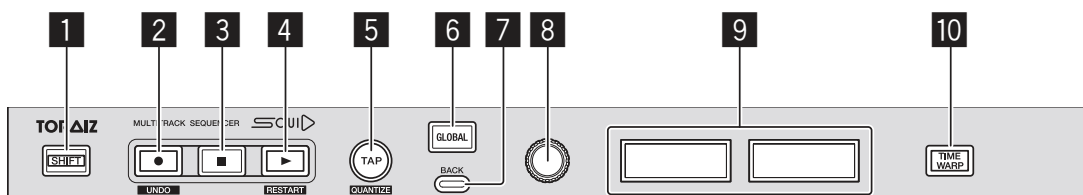

1 **SHIFT** button

When operating a button or knob while holding down the **[SHIFT]** button, you can access an alternative function.

2 ● **(record)** button

Toggles the pad performance, Harmonizer performance, and Real-time recording state of the automation information. For details, refer to “Real-time recording” (page 43).

[SHIFT] + press:

Switches the display to indications of the history. For details, refer to “UNDO” (page 104).

3 ■ **(stop)** button

Stops the pattern playback.

4 ► **(play)** button

Plays or pauses the pattern.

[SHIFT] + press:

Resumes the sequence playback from the first step.

5 TAP button

Sets the BPM of a sequence. Flashes to BPM during the sequence playback. For details, refer to “Setting the BPM (Beats Per Minute) of a sequence” (page 28).

[SHIFT] + press:

Switches the display to QUANTIZE setting. For details, refer to “QUANTIZE settings” (page 140).

6 GLOBAL button

Switches the display to the GLOBAL menu.

7 BACK button

Returns the display to a higher layer in the GLOBAL menu.

8 Rotary selector

Selects an item on the display and changes the setting.

9 Display

Shows various menus, BPM, beat indicator, track number, pattern number, page, etc.

10 TIME WARP button

Turns the Time Warp function to on or off. For details, refer to “TIME WARP” (page 106).

Phrase arrangement section

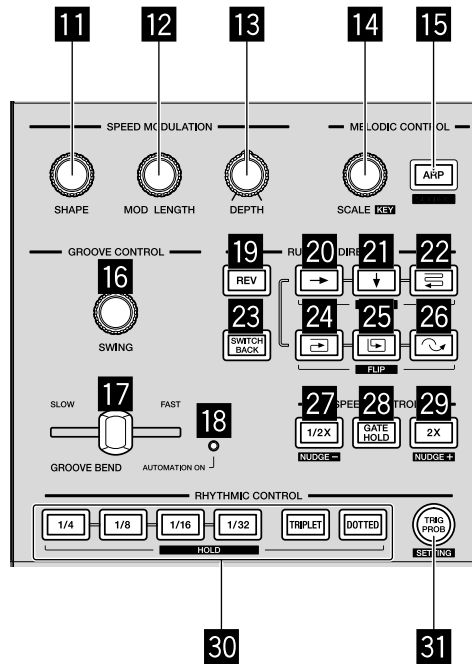

11 SHAPE knob

12 MOD LENGTH knob

13 DEPTH knob

11 to 13: Performs various operations for the Speed Modulation function. For details, refer to “SPEED MODULATION function” (page 80).

14 SCALE knob

15 ARP button

14 & 15: Performs various operations for the Melodic Control function. For details, refer to “MELODIC CONTROL function” (page 86).

16 SWING knob

17 GROOVE BEND slider

18 AUTOMATION ON indicator

16 to **18**: Used to perform various operations for the Groove Control function.
For details, refer to “GROOVE CONTROL function” (page 92).

19 REV button

20 → (right) button

21 ↓ (down) button

22 ⇄ (zigzag) button

23 SWITCH BACK button

24 ↻ (clockwise) button

25 ↺ (counterclockwise) button

26 ↺ (skip back) button

19 to **26**: Used to perform various operations for the Running Direction function.
For details, refer to “RUNNING DIRECTION function” (page 95).

27 1/2X (half) button

28 GATE HOLD button

29 2X (double) button

27 to **29**: Used to perform various operations for the Speed Control function. For details, refer to “SPEED CONTROL function” (page 99).

30 RHYTHM buttons

31 TRIG PROB button

30 & **31**: Used to perform various operations for the Rhythmic Control function.
For details, refer to “RHYTHMIC CONTROL function” (page 101).

Step edit section

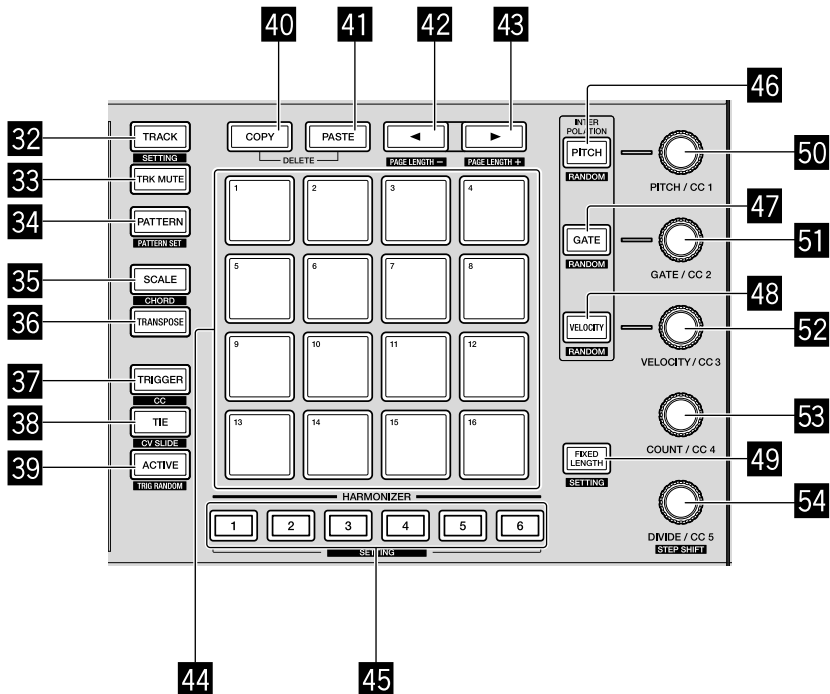

32 TRACK button

33 TRK MUTE button

34 PATTERN button

35 SCALE button

36 TRANSPOSE button

37 TRIGGER button

38 TIE button

39 ACTIVE button

32 to **39**: Switches the 16-pad function when each button is pressed. For details, refer to “Switching the 16-pad mode” (page 29).

40 COPY button

41 PASTE button

40 & **41**: Used to copy and paste specific information such as steps, patterns, pattern sets, and notes. Pressing both buttons at the same time enables deleting mode. For details, refer to “COPY/PASTE” (page 73) and “DELETE” (page 75).

42 ◀ button

43 ▶ button

42 & **43**: Used to change the length of a pattern and a page shown on the 16-pads. For details, refer to “Changing the pattern length” (page 55).

44 16-pads

Performs various operations depending on the pad mode.

45 HARMONIZER buttons

Changes a note to a chord while holding down the button. For details, refer to “HARMONIZER” (page 71).

46 PITCH button

47 GATE button

48 VELOCITY button

46 to **48**: Used to perform various operations for Interpolation and Randomizer. For details, refer to “INTERPOLATION” (page 67) and “RANDOMIZER” (page 70).

49 FIXED LENGTH button

Sets a pattern length to a specific length. For details, refer to “FIXED LENGTH” (page 79).

Part names and functions

50 PITCH/CC 1 knob

51 GATE/CC 2 knob

52 VELOCITY/CC 3 knob

53 COUNT/CC 4 knob

54 DIVIDE/CC 5 knob

50 to **54**: Used to change parameters of a note and step. For details, refer to “TRIGGER mode” (page 47) and “CC (Control Change) mode” (page 61).

Rear panel

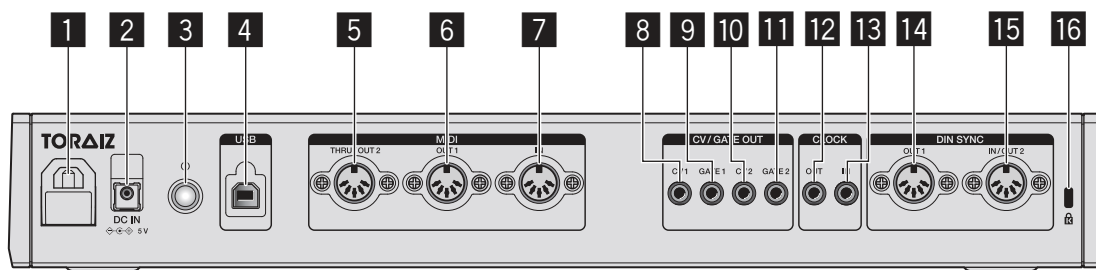

1 Cable hook

Hook the AC adapter cable when using this unit.
Refer to “How to use the cable hook” (page 20).

2 DC IN terminal

Connect the AC adapter cable.

3 power button

Turns the power of this unit On/Off.

 On/  Off

This switch is between off and on for this unit.

4 USB-B terminal

Connect to your PC/Mac.

- A USB hub cannot be used.
- To optimize performance, connect this unit and a PC/Mac directly using a USB 2.0 compliant USB cable.

5 MIDI THRU/OUT2 terminal

Connect to a device that receives MIDI signals from this unit.

6 MIDI OUT1 terminal

Connect to a device that receives MIDI signals from this unit.

7 MIDI IN terminal

Connect to a device that sends MIDI signals to this unit.

Part names and functions

8 CV OUT1 terminal

Connect to a device that receives CV signals from this unit.

9 GATE OUT1 terminal

Connect to a device that receives GATE signals from this unit.

10 CV OUT2 terminal

Connect to a device that receives CV signals from this unit.

11 GATE OUT2 terminal

Connect to a device that receives GATE signals from this unit.

12 CLOCK OUT terminal

Connect to a device that receives CLOCK signals from this unit.

13 CLOCK IN terminal

Connect to a device that sends CLOCK signals to this unit.

14 DIN SYNC OUT1 terminal

Connect to a device that receives DIN SYNC signals from this unit.

15 DIN SYNC IN/OUT2 terminal

Connect to a device that sends or receives DIN SYNC signals to or from this unit.

16 Kensington lock slot

Connections

- Be sure to turn off the power, disconnect the USB cable from this unit, and unplug the power cord from the power outlet whenever making or changing connections.
- Connect the power cord and a USB cable once all the connections between devices have been completed.
- Be sure to use the included power cord and AC adaptor.
- Refer to the operating instructions for components to be connected.
- Use a USB cable which complies with USB 2.0.
- The unit is powered by either the AC adapter or USB-bus power. The unit can be powered by just connecting the unit and your PC/ Mac via a USB cable without connecting the AC adaptor. If the AC adapter is connected at the same time, the USB-bus power can be used as a backup power source. If the AC adapter is disconnected while using the unit, the unit automatically switches the power source to the USB-bus power.
- To stabilize the power supply, be sure to connect the AC adapter connecting cord and a USB cable to the **[DC IN]** terminal and **[USB-B]** terminal tightly. If the connection is not secured, the unit may not operate stably.

Special notes when using USB-bus power

- There are some restrictions in functions such as dimming on buttons, LEDs for pads, and display.
- Be sure to connect the unit directly to a USB 2.0/3.0 port on your PC/ Mac using a USB cable.
- We recommend using a USB certified USB cable that is 2 meters (6.56 feet) or shorter to prevent stability issues.

Connecting inputs and outputs

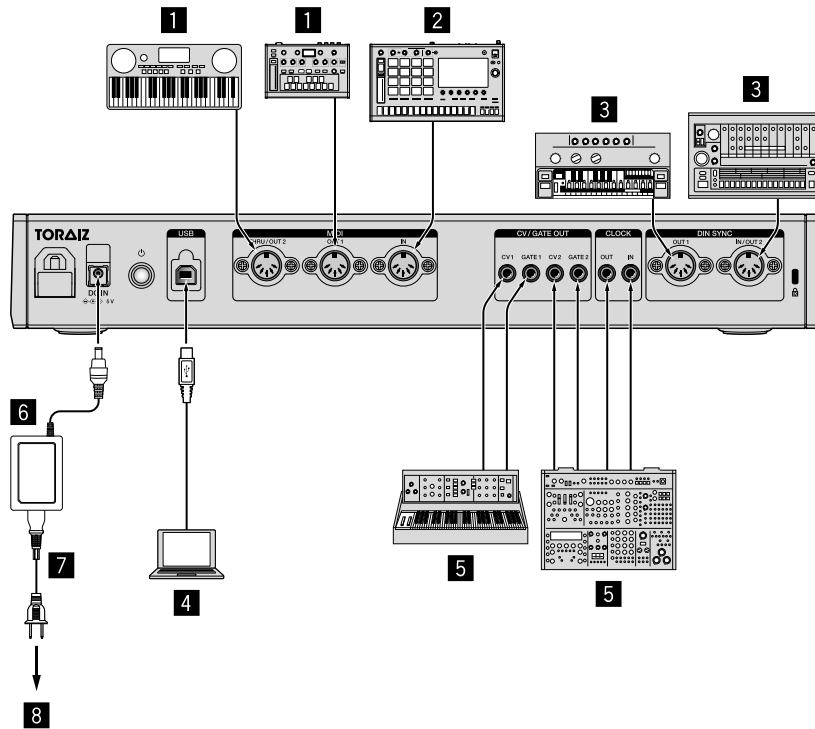

- 1** MIDI-compatible Synthesizer, Drum machine, Sound module, etc.
- 2** MIDI-compatible Synthesizer, Drum machine, Sound module, MIDI keyboard, etc.
- 3** DIN SYNC-compatible Synthesizer, Drum machine, Sound module, etc.
- 4** PC/Mac
- 5** CV/GATE/CLOCK-compatible Synthesizer, Drum machine, Sound module, etc.
- 6** AC adaptor (included)
- 7** Power cord (included)
- 8** To power outlet

How to use the cable hook

Hook the connection cable of the AC adaptor to avoid accidentally disconnecting it from the unit.

- 1 Fit the connection cable of the AC adaptor into the cable hook.

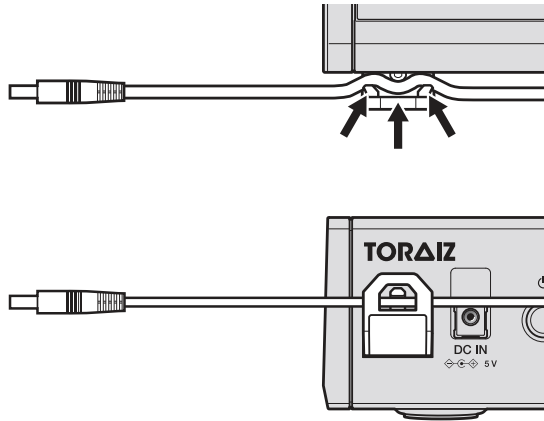

- 2 Connect the plug of the connection cable to the **[DC IN]** terminal (1). If the cable on the left side of the cable hook is too long, tighten it moderately (2).

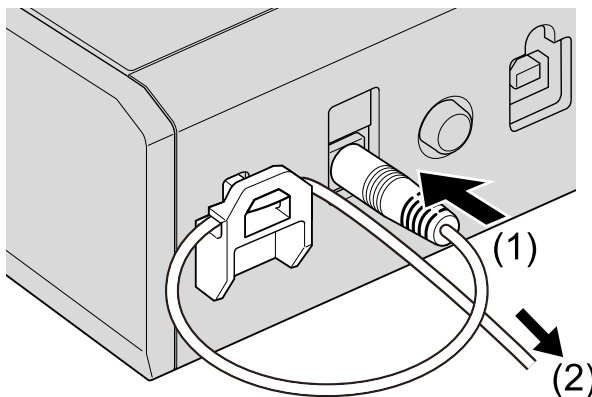

Note

Be sure to connect the AC adapter connecting cord to the **[DC IN]** terminal tightly. If the connection is not secured, the unit may not operate stably.

The data structure of the unit

The data structure of the unit is as shown below.

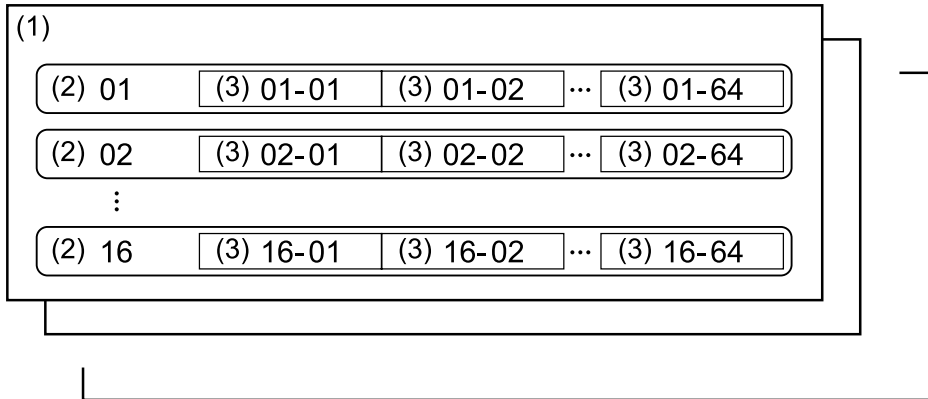

- (1) Project:
A project is a unit of work created by the user containing various information.
One project consists of 16 tracks.
- (2) Track:
Each track can create up to 64 patterns.
You can assign a track to a sound source such as track 1 to the drums, track 2 to the bass, track 3 to the synthesizer, etc.
- (3) Pattern:
A pattern is a sequence of performance information played by using various functions of the unit.
You can set the length of a pattern from 1 to 64 steps in step increments.

The maximum number of each element which can be created in this unit is as follows.

- The number of projects: 128
- The number of tracks for one project: 16
- The number of patterns for one track: 64
- The number of pattern sets for one project: 16
- The total number of patterns: 1600

Basic Operation

Project management

Creating a new project

- 1 Press the **[GLOBAL]** button.
The button lights up and you enter the GLOBAL menu.
- 2 Turn the rotary selector to select **[Create New]** and press it.
- 3 Turn the rotary selector to select **[OK]** and press it.
A new project is created.
 - If a new project is created without saving the current project, any changes will be lost. Be sure to save the current project if you want to maintain the changes.



1-A Project Settings

Create New

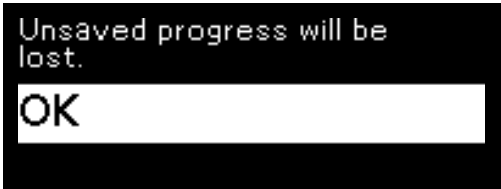

Unsaved progress will be lost.

OK

Loading a project

- 1 Press the **[GLOBAL]** button.
The button lights up and you enter the GLOBAL menu.
- 2 Turn the rotary selector to select **[Open(recent)]**, **[Open(by creation)]** or **[Open(by name)]** and press it.
 - Select **[Open(recent)]** to scroll through the projects in the order they were opened.
 - Select **[Open(by creation)]** to scroll through the projects in the order they were created.
 - Select **[Open(by name)]** to scroll through the projects in alphabetical order.
- 3 Turn the rotary selector to select a project and press it.
The project is loaded.

Overwriting a project

- 1 Press the **[GLOBAL]** button.
The button lights up and you enter the GLOBAL menu.
- 2 Turn the rotary selector to select **[Save]** and press it.
- 3 Turn the rotary selector to select **[OK]** and press it.
The project is overwritten.

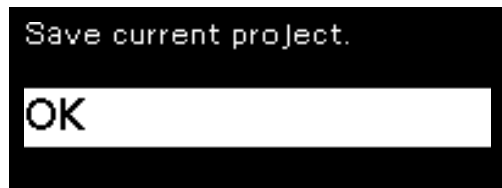
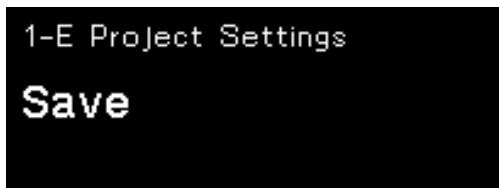

Naming and saving a project

- 1 Press the **[GLOBAL]** button.

The button lights up and you enter the GLOBAL menu.

- 2 Turn the rotary selector to select **[Save As]** and press it.

- Select **[Save]** to overwrite a project.

- 3 Press the **[▶]/[◀]** button to move the cursor and turn the rotary selector to change the character.

Name the project by repeating this step.

- Alphanumeric characters, symbols, or a blank space can be used.
- To delete a character at the cursor, hold down the **[SHIFT]** button and press the **[BACK]** button.
- To insert a blank space in front of the cursor, hold down the **[SHIFT]** button and press the rotary selector.
- When an existing project is loaded, its name is shown on the display.

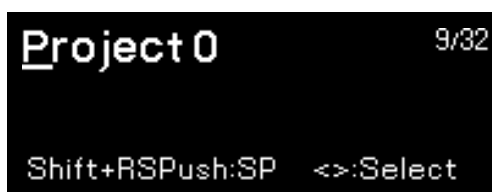

- 4 Press the rotary selector.

The project is saved.

Changing and overwriting a project name

- 1 Press the **[GLOBAL]** button.
The button lights up and you enter the GLOBAL menu.
- 2 Turn the rotary selector to select **[Rename & Save]** and press it.



- 3 Press the **[▶]/[◀]** button to move the cursor and turn the rotary selector to change the character.
 - For details, refer to step 3 in “Naming and saving a project” (page 24).
- 4 Press the rotary selector.
The project name is changed and overwritten.

Deleting a project

- 1 Press the **[GLOBAL]** button.
The button lights up and you enter the GLOBAL menu.
- 2 Turn the rotary selector to select **[Delete]** and press it.

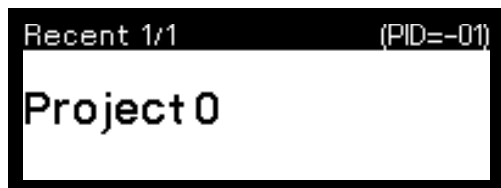

- 3 Turn the rotary selector to select a project and press it.
The selected project is deleted.

Transport

This chapter explains the functions using buttons and knobs in the Global section (page 9).

Playing a sequence

1 Press the **[▶]** (play) button.

The button lights up in green and a sequence is played.

The 16-pads light up depending on the direction of the step movement and the step state which is set through various pad modes.

- Up to 8 notes can be unmuted at the same time for each track.
- To pause the sequence playback, press the **[▶]** (play) button.
The button flashes when paused.
- To stop the sequence playback, press the **[■]** (stop) button.
The light of the **[▶]** (play) button turns off.

Recording the performance information into a sequence in real time (Real-time recording)

The information of the pad performance, the Harmonizer performance, and the automation can be recorded into a sequence.

- 1 Press the **[●]** (record) button.

The button lights up in red and recording standby mode is enabled.

- 2 Press the **[▶]** (play) button.

The button lights up in green. When the sequence starts playing, recordable mode is enabled.

- The following performance information can be recorded into a sequence;
 - Performance information using the 16-pads in Scale mode (page 39)
 - Performance information using the 16-pads in Chord mode (page 44)
 - Performance information made in combination with the **[HARMONIZER]** buttons (page 71)
 - Performance information using the 16-pads in Transpose mode (page 46)
 - Performance information of the **[GROOVE BEND]** slider (page 93)
 - Performance information of the **[SPEED CONTROL]** buttons (page 99)
 - Performance information of the **[RHYTHMIC CONTROL]** buttons (page 101)

Restarting a sequence

You can restart a sequence from the first step without stopping the playback.

- 1 Hold down the **[SHIFT]** button and press the **[▶]** (play) button.

The sequence restarts regardless of whether it is being played, paused, or stopped.

Setting the BPM (Beats Per Minute) of a sequence

The BPM can be set in the following method:

- Setting the BPM with a numerical value
- Setting the BPM by tapping the **[TAP]** button

❖ Setting the BPM with a numerical value

- 1 Press the **[TAP]** button.

The BPM indicator is highlighted on the display.



- 2 Turn the rotary selector to change the BPM.

The changed BPM is applied immediately.

- The value can be set from **[30 BPM]** to **[300 BPM]**.
- To change a value after the decimal point, hold down the **[SHIFT]** button and turn the rotary selector.
- Shortly after changing the BPM, the display returns to the former state.

❖ Setting the BPM by tapping the **[TAP]** button

- 1 Tap the **[TAP]** button twice or more.

The BPM is calculated based on the interval of tapping and applied immediately.

- The calculated BPM is shown for each tap.
- Shortly after tapping, the display returns to the former state.

Step edit section

Switching the 16-pad mode

You can switch the functions (the modes) of the 16-pads as needed.

- Track mode (page 31):
Selects a track (current track) to operate or edit from the 16 tracks.
- Track Mute mode (page 33):
You can toggle muting and solo of the 16 tracks.
- Pattern mode (page 34):
You can select a pattern (current pattern) to operate or edit from up to 64 patterns included in the current track.
- Pattern Set mode (page 37):
You can save a combination of patterns selected for each track or load them at once.
- Scale mode (page 39):
You can play scales using the 16-pads.
- Chord mode (page 44):
You can play chords using the 16-pads.
- Transpose mode (page 46):
You can transpose the current pattern in real time.
- Trigger mode (page 47):
You can set the note of each step (pad) to mute/unmute and changes various parameters of a note and a step (pad).
- CC mode (page 61):
You can assign up to 5 MIDI controller numbers to each track and set the MIDI control value to each step (pad).
- Tie mode (page 64):
You can set the Tie of each step (pad) connecting the sound of the previous step (pad).

Step edit section

- CV Slide mode (page 65):
You can set CV Slide for each step where the pitch is changed forward to the next step (pad) smoothly for each step.
This function is enabled only when the output terminal of the track is set to **[CV/GATE1]** or **[CV/GATE2]**.
- Active mode (page 66):
You can set each step to Active or Inactive. Inactive steps are removed from the sequence and skipped during the pattern playback.

TRACK mode

You can select a track (current track) to operate or edit from 16 tracks. The relation between the 16-pads and 16 tracks is as follows. (T: Track)

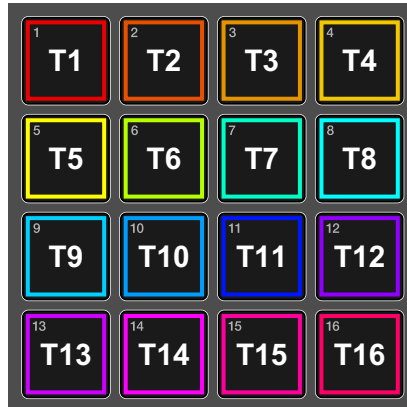

Selecting a track

- 1 Press the **[TRACK]** button.

The button lights up in white and the 16-pads switches to Track mode.

- When you are in other modes, you can also switch to Track mode by holding down the **[TRACK]** button. The 16-pads will return to the former state when released.

- 2 Press one of the 16-pads.

The corresponding track is loaded as the current track, and the pressed pad lights up bright in the track color. The other pads light dimly in the track color. The loaded current track number is shown on the display.

Example: When pressing pad 16



Note

During a sequence playback, each pad lights up in white when a note is triggered.

Selecting an output destination for the current track

- 1 Hold down the **[SHIFT]** button and turn the rotary selector to select an output terminal.

The followings are selectable.

[None] (no output), **[MIDI1]**, **[MIDI2]**, **[USB]**, **[CV/GATE1]**, **[CV/GATE2]**

- The output terminal according to the display is as follows.

MIDI1: **[MIDI OUT1]** terminal

MIDI2: **[MIDI THRU/OUT2]** terminal

USB: **[USB-B]** terminal

CV/GATE1: **[CV OUT1]** terminal, **[GATE OUT1]** terminal

CV/GATE2: **[CV OUT2]** terminal, **[GATE OUT2]** terminal

- 2 When selecting **[MIDI1]**, **[MIDI2]**, or **[USB]**, turn the rotary selector to select a channel.

The followings are selectable.

- MIDI1 Ch.1 to 16
- MIDI2 Ch.1 to 16
- USB Ch.1 to 16

Notes

- Even if you turn the rotary selector without performing step 1, you can select the output destination (terminal or channel) in the following order.

[None] (no output), **[MIDI1 Ch.1 to 16]**, **[MIDI2 Ch.1 to 16]**, **[USB Ch.1 to 16]**, **[CV/GATE1]**, **[CV/GATE2]**

- For settings other than output destinations, refer to “TRACK settings” (page 145).

TRACK MUTE mode

Toggles between on and off for muting and solo.

The relation between the 16-pads and 16 tracks is as follows. (T: Track)



1 Press the **[TRK MUTE]** button.

The button lights up in yellow and the 16-pads switches to Track Mute mode.

- When you are in other modes, you can also switch to Track Mute mode momentarily by holding down the **[TRK MUTE]** button. The 16-pads will return to the former state when released.

2 Press the 16-pads to mute them, or hold down the **[SHIFT]** button and press the 16-pads to solo them.

The light of the pad set to mute turns off. The information of the corresponding track will not be output. To unmute, press the pad again. The pad set to solo lights up in red. Only the information of the corresponding track will be output. To unsolo, hold down the **[SHIFT]** button and press the pad again. When all of the tracks are unsoloed, the 16-pads automatically returns to mute/unmute mode.

- You can solo multiple tracks.
- You can also mute/unmute tracks while in solo mode. (Soloed tracks cannot be muted.)
- To unmute or unsolo all the tracks at once, hold down the **[SHIFT]** and press the **[TRK MUTE]** button.

Note

During a sequence playback, each triggered pad lights up in white.

PATTERN mode

You can select a pattern (current pattern) to operate or edit from up to 64 patterns included in the current track.

Loading a pattern

1 Press the **[PATTERN]** button.

The button lights up in green and the 16-pads switches to Pattern mode.

- The lighting state changes depending on the state of each pad.
 - Lit bright: A pad selected as the current pattern
 - Lit dimly: A pad where a pattern is saved
 - Off: A pad where no pattern is saved
- When you are in other modes, you can also switch to Pattern mode momentarily by holding down the **[PATTERN]** button. The 16-pads will return to the former state when released.

2 Press the **[▶]/[◀]** button to move between pattern pages.

You can save up to 4 pages containing 16 patterns per page, a total of 64 patterns.

Step edit section

The relation between the 16-pads and 64 patterns is as follows. (P: Pattern)
(1) Pattern page 1, (2) Pattern page 2, (3) Pattern page 3, (4) Pattern page 4

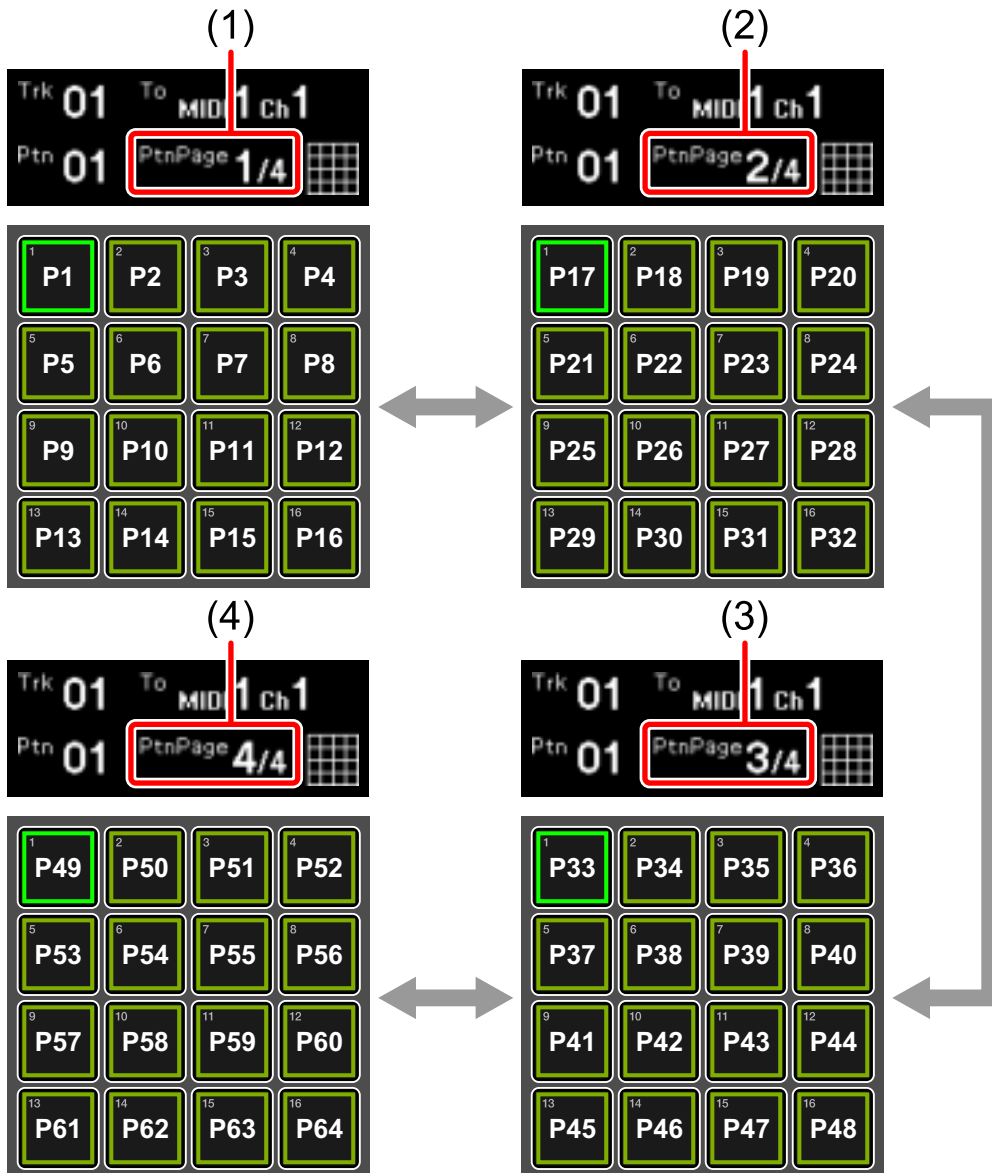

3 Press one of the 16-pads.

When pressing a pad where a pattern is saved (which is lit fully or lit dimly), the pad lights up and is loaded as the current pattern.

When pressing a pad where no pattern is saved (whose light is turned off), an empty pattern is loaded.

The number of the pattern loaded is shown on the display.

Example: When pressing pad 16



- When you switch the pattern during playback, the switch is applied at the first beat of the next bar. The pad flashes in white until the pattern is switched.
- When pressing 16-pads while holding down **[SHIFT]**, the pattern is switched immediately.

Saving a pattern

Select a pad where no pattern is saved (where the light is turned off) and make changes to it, such as adding triggers and editing note information. The changes will be saved to the pattern automatically.

Deleting a pattern

- 1 In Pattern mode, hold down the **[COPY]** button and **[PASTE]** button together, and press a pad that contains a pattern.
The light of the pad that is pressed turns off and the pattern is deleted.

PATTERN SET mode

You can save a combination of patterns selected for each track or load them at once.

Up to 16 pattern sets can be saved in the 16-pads as follows. (PS: Pattern Set)



Loading a pattern set

- 1 Hold down the **[SHIFT]** button and press the **[PATTERN]** button. The **[PATTERN]** button flashes in green and the 16-pads switch to Pattern Set mode.
 - The lighting state changes depending on the state of each pad.
 - Lit brightly: A pad for the currently loaded pattern set
 - Lit dimly: A pad where a pattern set is saved
 - Off: A pad where no pattern set is saved
- 2 Press one of the 16-pads which is dimly lit. The pad that is pressed lights up, and the saved pattern set is loaded.
 - When you switch the pattern set during playback, the switch is applied at the first beat of the next bar. The pad flashes in white until the pattern set is switched.

Saving a pattern set

- 1 In Pattern Set mode, press a pad where no pattern set is saved (where the light is turned off).
The pad that is pressed lights up and the combination of current patterns for each track is saved.

Deleting a pattern set

- 1 In Pattern Set mode, hold down the **[COPY]** button and **[PASTE]** button together, and press a pad that contains a pattern set.
The light of the pad that is pressed turns off and the pattern set saved in it is deleted.

SCALE mode

You can play scales using the 16-pads.

Playing scales by tapping the 16-pads

1 Press the **[SCALE]** button.

The button lights up in red and the 16-pads switches to Scale mode.

- The lighting state changes depending on the scale selected in the Melodic Control function. For details, refer to “Setting the Scale” (page 87).
 - Lit bright: The keynote of a scale selected in the Melodic Control function
 - Lit dimly: The consisting note of a scale selected in the Melodic Control function
 - Off: The note of a scale selected in the Melodic Control function

Example: C Ionian scale

The lighting state of the note and the pad set on the 16-pads is as follows.

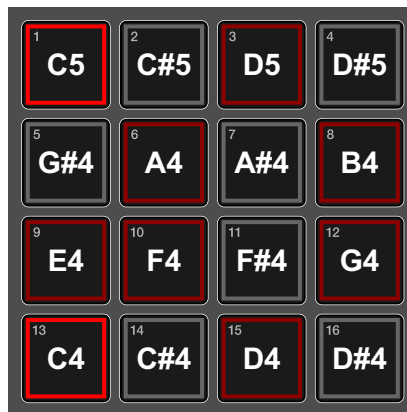

2 Perform by tapping the 16-pads.

The tapped pad lights up in white. The corresponding note is output.

- Up to 8 notes can be output at the same time for each track.
- The output note is automatically corrected according to the scale selected in the Melodic Control function. If the note that is not in the selected scale (the pad where the light is turned off) is played, the output note will be corrected to the closest note in the scale and the note set to the pad that is lit in white will be output.

Changing the note range of the 16-pads

In Scale mode, you can change the note range that can be played with the 16-pads.

- 1 Press the **[SCALE]** button.

The button lights up in red and the 16-pads switches to Scale mode.

- 2 Press the **[▶]/[◀]** button.

When you press the **[▶]** button, the scale range increases by four semitones.

When you press the **[◀]** button, the scale range decreases by four semitones.

The note range is shown in **[Range]** on the display.

Example: Pressing the **[▶]** button to increase the scale range by four semitones

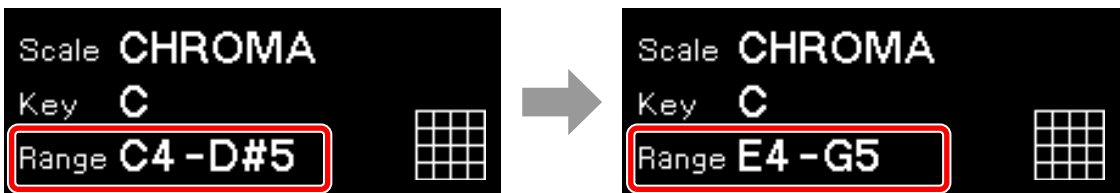

The lighting state of the note and the pad set on the 16-pads is as follows.

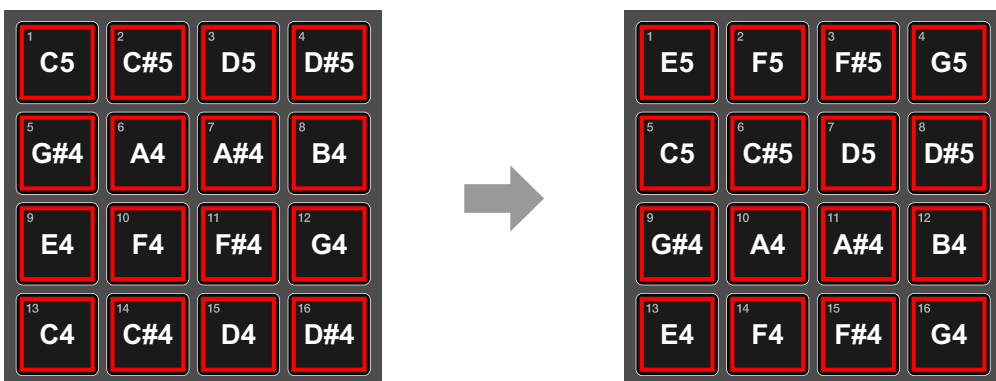

Playing using the Note Repeat function

You can obtain the effect of tapping the 16-pads repeatedly at regular intervals.

- 1 Press the **[SCALE]** button.

The button lights up in red and the 16-pads switches to Scale mode.

- 2 Turn the rotary selector to select a position for the Note Repeat function.

When **[Note Repeat(Top pads)]** or **[Note Repeat(Bottom pads)]** is selected, Note Repeat pads are shown in the top or lowermost part of the scale pads.

The Note Repeat pads are lit dimly in orange or green.

- Note Repeat(Top pads): Note Repeat pads are located on PAD 1 to PAD 4.

(1) Note Repeat pad



- Note Repeat(Bottom pads): Note Repeat pads are located on PAD 13 to PAD 16.

(1) Note Repeat pad



- The Note Repeat Pads are located as follows:
(1) 1/8 (eighth note), (2) 1/16 (sixteenth note), (3) 1/32 (thirty-second note),
(4) Triplet
You can repeat the notes in triplets by holding down the Triplet pad (4)
together with Note Repeat Pads (1) to (3).

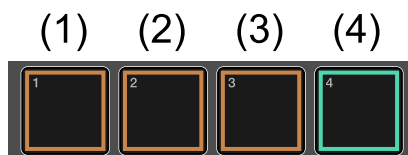

- 3 Hold down the Note Repeat pad and press the scale pad to play.
The pressed Note Repeat pad lights up, the pressed scale pad lights up in white, and the notes are output repeatedly at the beat intervals designated by the Note Repeat pad.

Using Pad Sequence Start to play a sequence

The Pad Sequence Start function can be used to play a sequence when the pad is tapped.

- 1 Press the **[SCALE]** button.
The button lights up in red and the 16-pads switches to Scale mode.
- 2 Hold down the **[SHIFT]** button and tap any pad.
 - While a sequence is stopped, the sequence is played from the beginning when a pad is tapped.
 - While a sequence is paused, the sequence is played from where it is paused when a pad is tapped.

Real-time recording

You can record note information by tapping the pads at any time when the pattern is being played in recording mode.

- 1 Press the **[SCALE]** button.
The button lights up. The light of the 16-pads brightens in red, dims in red or turns off.
- 2 Press the **[●]** (record) button.
The button lights up in red and recording mode is enabled.
- 3 Press the **[▶]** (play) button.
The button lights up in green and a pattern is played in recording mode.
- 4 Perform by tapping the 16-pads.
The notes will be recorded in the pattern by tapping the pads.
The pad corresponding to the note that is triggered lights up in white.
- 5 Press the **[●]** (record) button again.
The light of the button turns off and the unit exits recording mode.
 - Up to 8 notes can be recorded for one step.

Notes

- You can edit the information of the recorded note in steps. For details, refer to “Step Recording on the 16-pads” (page 51).
- When a note is recorded, the gap of the timing can be corrected. For details, refer to “QUANTIZE settings” (page 140).

CHORD mode

You can play chords using the 16-pads.

Playing chords by tapping the 16-pads

- 1 Hold down the **[SHIFT]** button and press the **[SCALE]** button.
The button flashes in red and the 16-pads switches to Chord mode.
- 2 Perform by tapping the 16-pads.
The tapped pad lights up in pink and the notes of the chords already set in the pad are output. The other pads are lit dimly in pink.
 - Up to 8 notes can be output at the same time for each track.
 - The output note is automatically corrected according to the scale selected in the Melodic Control function (page 86).
 - Up to 5 chords can be output by tapping one pad.

Setting a set number

There are 18 different chord sets available in Chord mode.

- 1 Hold down the **[SHIFT]** button and press the **[SCALE]** button.
The button flashes in red, and the 16-pads lights up in pink or lights dimly.
- 2 Turn the rotary selector to select a set number.
The set number to be set is shown in **[Set No.]** on the display.

Setting TRANSPOSE

You can transpose the chords in the chord set.

- 1 Hold down the **[SHIFT]** button and press the **[SCALE]** button.
The button flashes in red and the 16-pads switches to Chord mode.
- 2 Press the **[▶]/[◀]** button to adjust the transposition quantity.
When pressing the **[▶]** button, it increases by one semitone. When pressing the **[◀]** button, it decreases by one semitone. The transposition quantity is shown in **[Transpose]** of the display.
 - The range of the transposition quantity is from -12 semitones to +12 semitones.

TRANPOSE mode

Transposes the current pattern in real time by pressing the 16-pads. The transpose value set to each pad is as follows.

1 +5	2 +7	3 +10	4 +12
5 +1	6 +2	7 +3	8 +4
9 -4	10 -3	11 -2	12 -1
13 -12	14 -10	15 -7	16 -5

- 1 Press the **[TRANPOSE]** button.
The button lights up in red and the 16-pads switches to Transpose mode.
- 2 Hold down one of the 16-pads.
The pad being held down lights up brightly from the dim state and the pitch changes according to the transpose value. When you release the pad, it returns to the former pitch.
Example: While holding down the +5 pad
The pad increases by five semitones (2) from the former pitch (1).

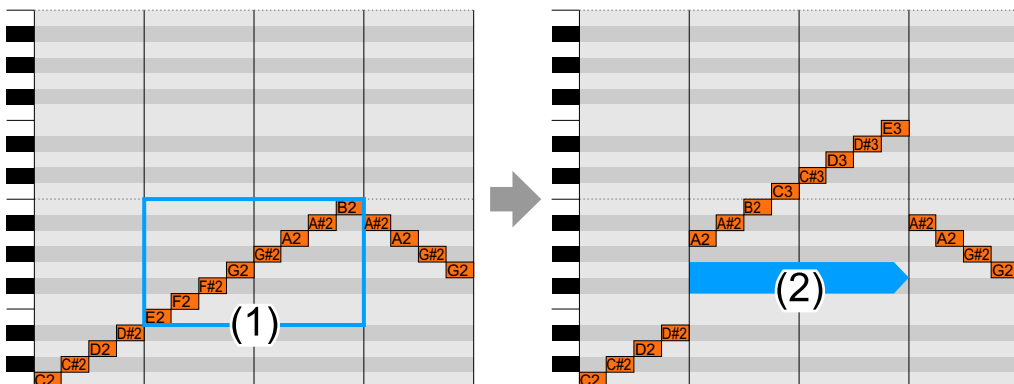

TRIGGER mode

You can create phrases by sequencing (step recording) each pad (step), the mute/unmute state for each note included in the pad, and various parameters.

The relationship between the 16-pads and the step in TRIGGER mode

On this unit, step recording can be performed by setting various parameters to each pad. When regarding the 16 pads (4 pads by 4 pads) as one page, it can extend up to 4 pages for a pattern. Therefore, you can create a pattern with up to 64 pads.

Basically, one pad corresponds to one step; however, you can change the number of steps counted with one pad by setting the COUNT value (page 49) for each pad.

Also, you can create patterns with steps that are not in multiples of 16 by using functions such as Active mode (page 66) and Fixed Length (page 79).

Note

You can modify the resolution of each pad for a pattern. In the default setting, one pad (one step) is equal to the sixteenth note. For details, refer to “TRACK settings” (page 145).

The parameters used for TRIGGER mode

You can set the following parameters included in each pad (step) and each note in Trigger mode.

❖ The parameters included in each note (note information)

The following parameters can be set to each note.

- PITCH value:
Adjusts the pitch of a note.
The setting range is **[C-1]** to **[G-9]**. The default value is **[C4]**.
- GATE value:
Adjusts the length of a note.
The setting range is **[0.125step]** to **[64.000step]**. The default value is **[1.000step]**.
- VELOCITY value:
Sets the strength and weakness of a note.
The setting range is **[0]** to **[127]**. The default value is **[100]**.
- OFFSET value:
Adjusts the timing of notes triggered.
Normally a note is triggered at the same time as the steps proceed; however, the trigger timing can be delayed up to 5/6 step in 1/6 step units. In the default setting, a note is triggered at the same time as a step proceeds.

(1) 1 step, (2) Note, (3) OFFSET value

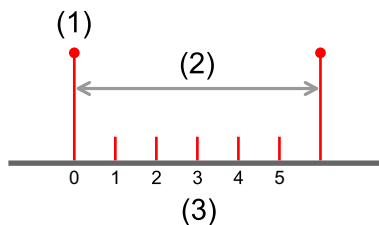

❖ The parameters for each pad (step)

The following parameters can be set to each pad (step).

- COUNT value:

Sets the number of steps to count for each pad.

When the COUNT value is **[1]**, the pad proceeds to the next pad after the duration of one step. When the COUNT value is set to **[3]**, the pad proceeds to the next pad after the duration of three steps. The setting range is **[1]** to **[4]**. The default value is **[1]**.

(1) When the COUNT value of all the pads is 1

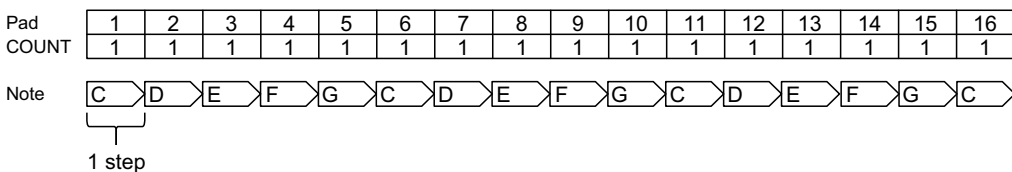

(2) When the COUNT value 3 is set to pad 6

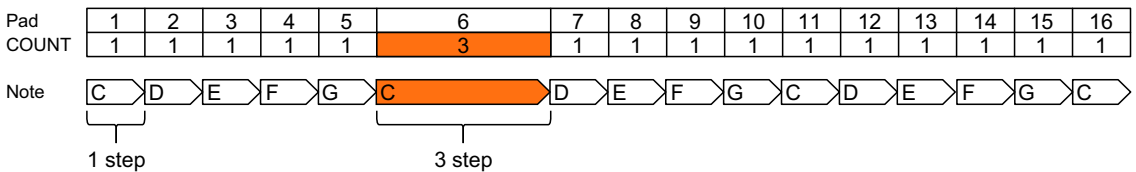

- **DIVIDE value:**

Sets the number of times a note is triggered for each pad.

When the DIVIDE value is **[1]**, the pad is triggered once. When the DIVIDE value is set to **[3]**, the pad is triggered three times and the GATE value of the note automatically decreases to 1/3 of the length. The setting range is **[1]** to **[4]**. The default value is **[1]**.

(1) When the DIVIDE value of all the pads is 1

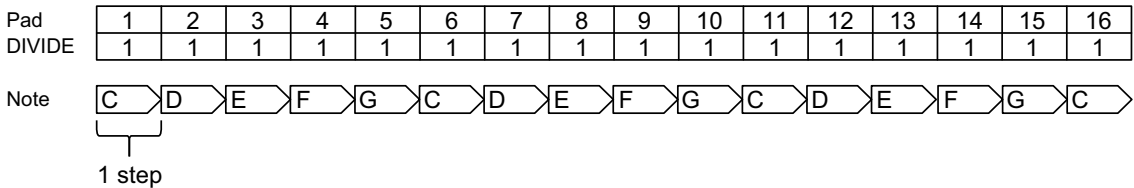

(2) When the DIVIDE value 3 is set to pad 6

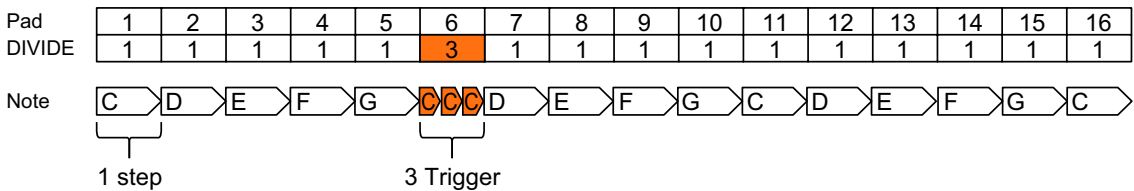

Notes

- Even if the COUNT value is set to **[2]** to **[4]**, the number of times a note is triggered will not change.
- If Tie is set to the pad after the pad where the DIVIDE value is set to **[2]** to **[4]**, both DIVIDE and Tie are applied.

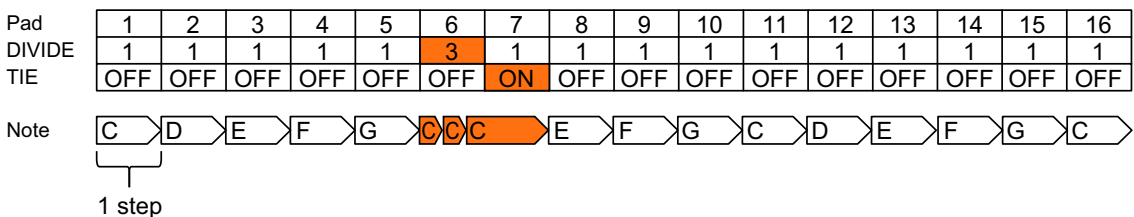

Step Recording on the 16-pads

1 Press the [TRIGGER] button.

The button lights up in orange and the 16-pads switches to Trigger mode.

- The lighting state of each pad indicates the states of unmuting/muting, Tie, Active, and CV Slide.
 - Lit in orange: Unmuted
 - Flashing in orange: Unmuted + CV Slide
 - Lit dimly in orange: Muted
 - Flashing dimly in orange: Muted + CV Slide
 - Lit in purple: Unmuted + Tie
 - Flashing in purple: Unmuted + Tie + CV Slide
 - Lit dimly in purple: Muted + Tie
 - Flashing dimly in purple: Muted + Tie + CV Slide
 - Off: Disabled (inactive)

Notes

- The pad being played lights up in white during the pattern playback.
- If you hold down the pad, various parameters such as note information recorded in each pad will be shown on the display. Also, you can check with the output sound from the connected device by outputting the note information of the pad being held down as the MIDI message. You can select whether or not to output the MIDI message. For details, refer to “Step Preview” (page 138) in the GLOBAL menu.

(1) Pad number, (2) Note being selected, (3) DIVIDE value, (4) COUNT value, (5) OFFSET value, (6) PITCH value, (7) GATE value, (8) VELOCITY value

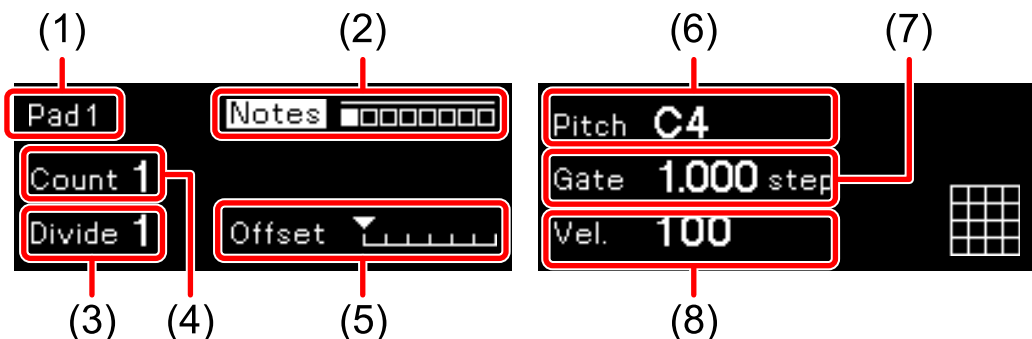

- CV Slide can be enabled only when the output terminal of a track is set to **[CV/GATE1]** or **[CV/GATE2]**.
- 2 Press the 16-pads to mute/unmute for each pad (step).
Repeatedly pressing the pad switches between the unmuted state (lit) of outputting the note information set to the pad and muted state (lit dimly) of no output.
 - 3 Set the note information of each pad (step).
Up to 8 multiple note information can be set to each pad (step).
 - When setting one note information to one pad, refer to “Setting one note information (Monophonic note) to one pad” (page 53).
 - When setting multiple note information to one pad, refer to “Setting multiple note information (Polyphonic note) to one pad” (page 53).
 - 4 Hold down the pad to set a parameter of each pad (step) and turn the **[COUNT/CC4]** or **[DIVIDE/CC5]** knob.
The parameter information will be shown on the display and you can set the corresponding parameters as follows.
 - **[COUNT/CC4]** knob: COUNT value
 - **[DIVIDE/CC5]** knob: DIVIDE value

Notes

- While holding down multiple pads and performing the operations above, you can change the parameters of all the pads that are held down at the same time.
- While not holding down any pad and performing the operations above, you can change the parameters of all the pads in the current pattern at the same time.

❖ Setting one note information (Monophonic note) to one pad

- 1 Hold down the pad to set the note information and turn the **[PITCH/CC1]**, **[GATE/CC2]**, or **[VELOCITY/CC3]** knob, or press the **[▶]/[◀]** button.

The note information will be shown on the display and you can set the corresponding parameters as follows.

- **[PITCH/CC1]** knob: PITCH value
- **[GATE/CC2]** knob: GATE value
- **[VELOCITY/CC3]** knob: VELOCITY value
- **[▶]/[◀]** button: OFFSET value

Notes

- While holding down multiple pads and performing the operations above, you can change the parameters of all the pads that are held down at the same time.
- While not holding down any pad and performing the operations above, you can change the parameters of all the pads in the current pattern at the same time.

❖ Setting multiple note information (Polyphonic note) to one pad

- 1 Hold down the pad to set the note information and turn the rotary selector.

The note information will be shown on the display. You can switch the corresponding note in the order of **[Note]**, **[Note1]**, **[Note2]**, and so on to **[Note8]** by turning the rotary selector to show the note to set.

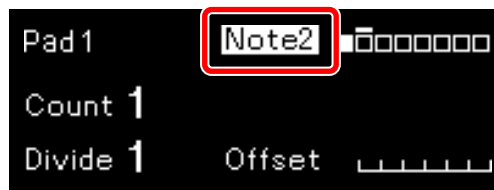

2 Continue to hold down the pad and press the rotary selector.

Repeatedly pressing the rotary selector switches between the unmuting state and muting state. The unmuting/muting state is shown on the display.

- White square (□): Unmuted
- Black square (■): Muted

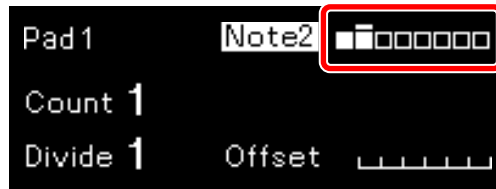

3 Continue to hold down the pad and turn the **[PITCH/CC1]**, **[GATE/CC2]**, or **[VELOCITY/CC3]** knob, or press the **[▶]/[◀]** button.

The note information will be shown on the display and you can set the corresponding parameters as follows.

- **[PITCH/CC1]** knob: PITCH value
- **[GATE/CC2]** knob: GATE value
- **[VELOCITY/CC3]** knob: VELOCITY value
- **[▶]/[◀]** button: OFFSET value

4 Repeat step 1 to 3.

Notes

- While performing the operations above for **[Notes]** to perform settings after setting a polyphonic note, you can change the parameters of all the notes included in the pad at once.
- While holding down multiple pads and performing the operations above, you can change the parameters of all the pads that are held down at the same time. At this time, you cannot switch a note to set by turning the rotary selector.
- While not holding down any pad and performing the operations above, you can change the parameters of all the pads in the current pattern at the same time. At this time, you cannot switch a note to set by turning the rotary selector.

- While holding down the pad where a polyphonic note is set, the note information shown on the display switches to the range indication.

Changing the pattern length

When regarding the 16 pads as one page, the pattern length can extend up to 4 pages (64 pads).

- 1 Hold down the **[SHIFT]** button and press the **[▶]/[◀]** button.
You can increase the maximum number of pages with the **[▶]** button or decrease it with **[◀]** button. The maximum number of pages that is changed is shown on the display.
- 2 Press the **[▶]/[◀]** button.
When changing the maximum number of pages to 2 pages or more, you can switch the page indicated on the 16-pads. The page indicated on the 16-pads is shown on the display.
 - White square (□): Valid page
 - Black square (■): Displayed page
 - Bar above square: The page position where the sequence is playing



Notes

- The pattern length can be changed in the following mode besides Trigger mode.
 - Track mode
 - Track Mute mode
 - Scale mode
 - Transpose mode
 - CC mode

- CV Slide mode
- Basically one pad corresponds to one step; however, you can change the number of steps counted with one pad by setting the COUNT value (page 49) for each pad. Also, you can create a pattern with steps that are not in multiples of 16 by using the functions such as Active mode (page 66) and Fixed Length (page 79).
- You can modify the resolution of each pad for a pattern. In the default setting, one pad (one step) is equal to the sixteenth note. For details, refer to “TRACK settings” (page 145).

Supplemental information: The operations when changing note information of multiple pads and parameters of a pad (step) at the same time

The operations differ by the note information to change and the type of parameters of a pad (step).

❖ PITCH value

The PITCH values are changed evenly; however, when the maximum PITCH value reaches note number 127 or the minimum PITCH value reaches note number 0, you can no longer change the value. As a result, the PITCH value among multiple pads maintains the same level.

Step edit section

- (1) When the maximum PITCH value reaches note number 127
- (2) When the minimum PITCH value reaches note number 0

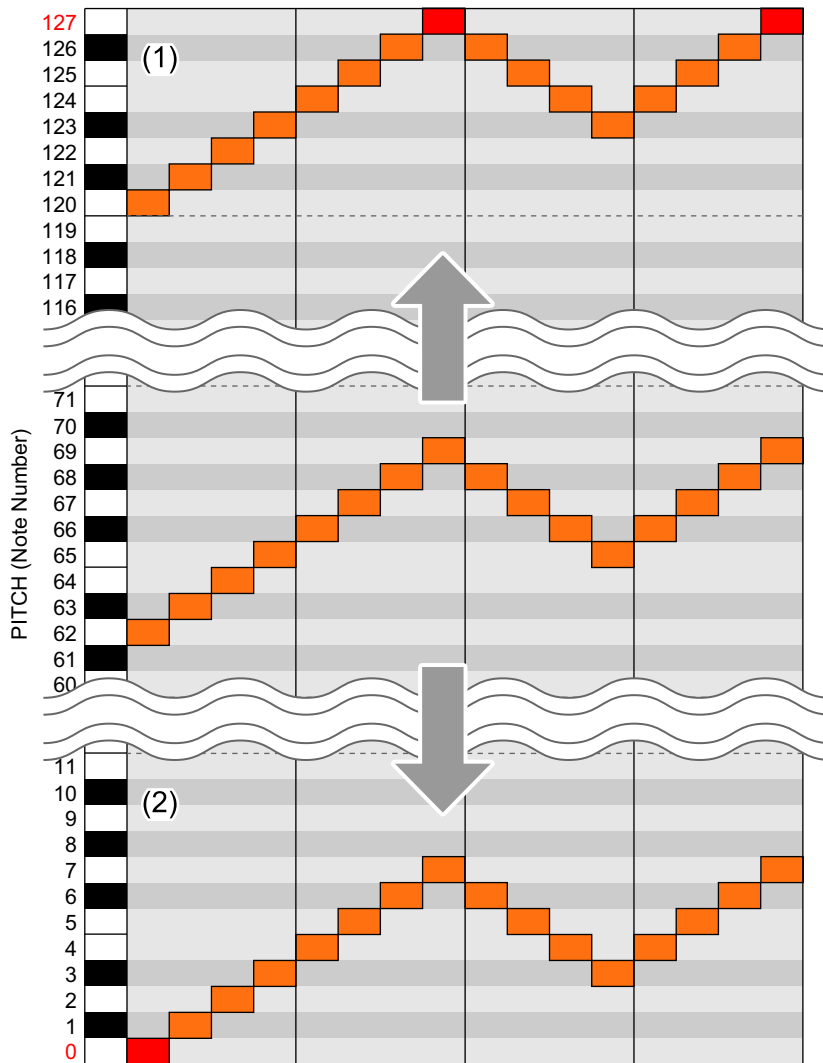

❖ **GATE value, VELOCITY value, COUNT value, DIVIDE value**

The parameters above included in multiple pads are changed evenly; however, even if the maximum value or minimum value of each parameter reaches the following value, further changes can be made. As a result, all the changed parameters of multiple pads stick to the maximum or minimum value.

- | | | |
|-------------------|-------------------------------|------------------------------|
| • GATE value: | maximum value:
64.000 step | minimum value:
0.125 step |
| • VELOCITY value: | maximum value: 127 | minimum value: 0 |
| • COUNT value: | maximum value: 4 | minimum value: 1 |
| • DIVIDE value: | maximum value: 4 | minimum value: 1 |

Example 1: When VELOCITY value increases

(1) VELOCITY value increases evenly

(2) VELOCITY value can increase to its maximum

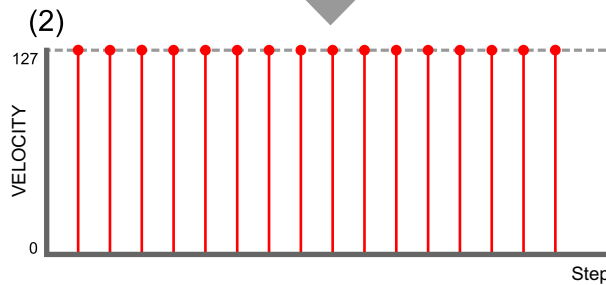
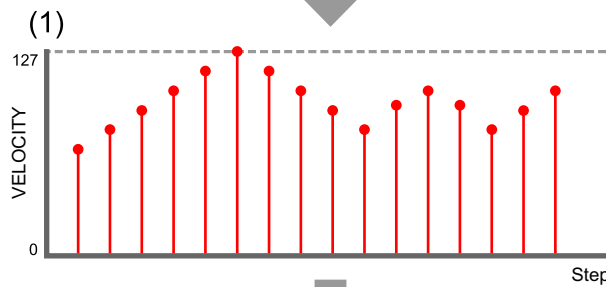
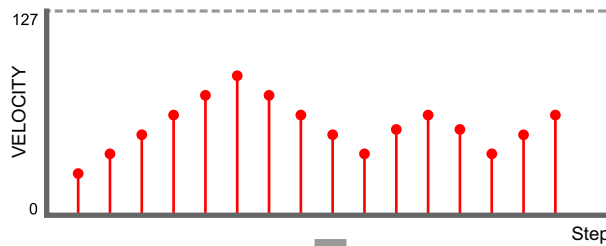

Example 2: When VELOCITY value decreases

(1) VELOCITY value decreases evenly

(2) VELOCITY value can decrease to its minimum

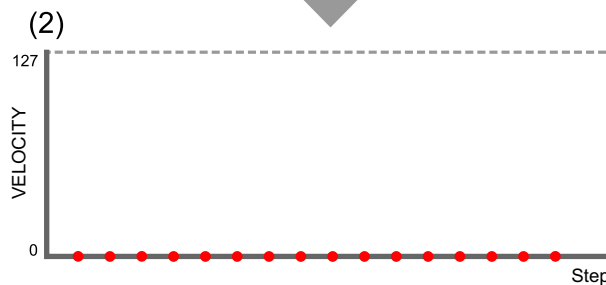
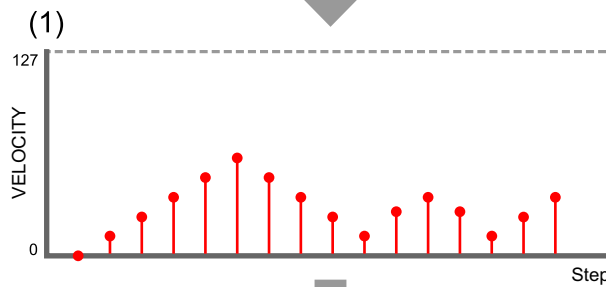
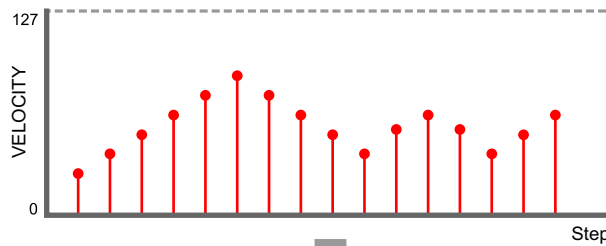

CC (Control Change) mode

You can control the parameters of external equipment from the unit by assigning up to 5 MIDI controller numbers to each track and sequencing (step recording) the MIDI control values into each pad (step).

The parameters used for CC mode

- MIDI CC number 1:
Controller number assigned to the **[PITCH/CC1]** knob
The setting range is **[#000]** to **[#127]**.
- MIDI CC number 2:
Controller number assigned to the **[GATE/CC2]** knob
The setting range is **[#000]** to **[#127]**.
- MIDI CC number 3:
Controller number assigned to the **[VELOCITY/CC3]** knob
The setting range is **[#000]** to **[#127]**.
- MIDI CC number 4:
Controller number assigned to the **[COUNT/CC4]** knob
The setting range is **[#000]** to **[#127]**.
- MIDI CC number 5:
Controller number assigned to the **[DIVIDE/CC5]** knob
The setting range is **[#000]** to **[#127]**.
- MIDI CC value:
Control value set to each pad (step)
The setting range is **[0]** to **[127]** and the default value is **[0]**.

Step recording the control value on the 16-pads

- 1 Hold down the **[SHIFT]** button and press the **[TRIGGER]** button. The **[TRIGGER]** button flashes in orange and the 16-pads switches to CC mode. The controller number and control value are shown on the display.

(1) Controller number, (2) Control value

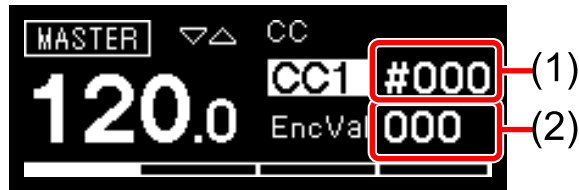

- 2 Turn the rotary selector to switch the knob to be assigned with the controller number.

The knob to be assigned is highlighted on the display and the 16-pads indicates the assignment by the lighting color as follows.

- [CC1]: [PITCH/CC1] knob** 16-pads: Blue
- [CC2]: [GATE/CC2] knob** 16-pads: Light blue
- [CC3]: [VELOCITY/CC3] knob** 16-pads: Green
- [CC4]: [COUNT/CC4] knob** 16-pads: Yellow green
- [CC5]: [DIVIDE/CC5] knob** 16-pads: Yellow

- When you turn the knob that you want to assign to, the knob is assigned to instantly.

(1) Knob

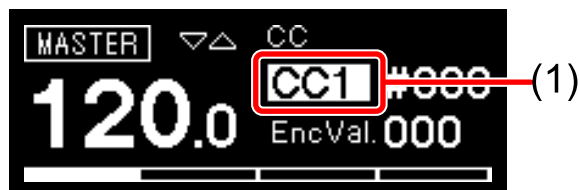

3 Press the rotary selector.

The highlight on the display moves to the controller number.

(1) Controller number

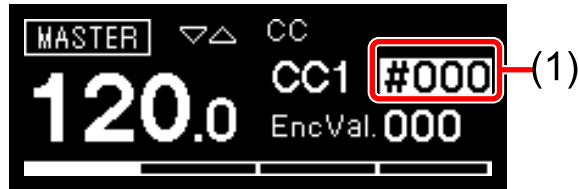

4 Turn the rotary selector to select the controller number.

- Pressing the rotary selector toggles the highlight between assigning to the knob and setting the controller number.

5 Press the 16-pads to switch the output of the control value.

- Pressing the same pad toggles the output of the control value on (lit) and off (lit dimly).

6 Hold down the pad to set control value on and turn the **[PITCH/CC1]**, **[GATE/CC2]**, **[VELOCITY/CC3]**, **[COUNT/CC4]**, or **[DIVIDE/CC5]** knobs that corresponds to the controller number that you want to set.

- The controller number and the control value are shown on the display.

(1) Controller number, (2) Control value

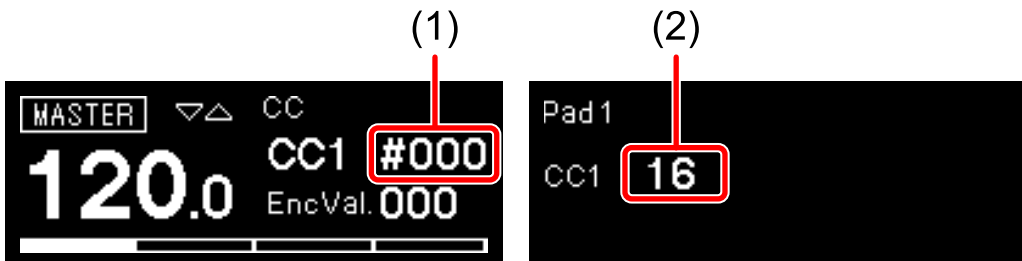

Notes

- When you turn the knob that corresponds to the controller number that you want to set, the controller number is switched instantly.
- While holding down multiple pads and performing the operations above, you can change the control values of all the pads that are held down at the same time.

TIE mode

You can set the tie of each step (pad), connecting the sound of the previous step (pad).

Setting TIE to a step

- 1 Press the **[TRIGGER]** button.
The button lights up in orange and the 16-pads switches to Trigger mode.
- 2 Hold down the **[TIE]** button and press the pad of the step to set Tie to.
The **[TIE]** button lights up in orange. Hold down the 16-pads to enter Tie mode. The pad of the step where Tie is on lights up in purple.
 - Pressing the same pad toggles the Tie on and off.
- 3 Release the **[TIE]** button.
The 16-pads returns to Trigger mode.

Note

When 2 or more DIVIDE value are set on the step prior to the step where Tie is set, Tie is applied to the last note that is divided.

CV SLIDE mode

In this mode, each step can be set with CV Slide which changes the PITCH value smoothly forward to the PITCH value of the next step (pad). This mode is available when **[CV/GATE1]** or **[CV/GATE2]** is set.

Setting CV SLIDE to a step

- 1 Hold down the **[SHIFT]** button and press the **[TIE]** button.
The **[TIE]** button flashes in orange and the 16-pads switches to CV Slide mode.
- 2 When there are multiple pages in the 16-pads, press the **[▶]/[◀]** button to select a page.
The selected page is applied to the 16-pads.
 - For details on pages, refer to “Changing the pattern length” (page 55).
- 3 Press the pad of the step to set CV Slide to.
The pad of the step where CV Slide is on lights up in purple.
The PITCH value can be changed smoothly from the step (pad) with CV Slide to the next step (pad).
 - Pressing the same pad toggles the CV Slide on and off.

Note

The MIDI output is not affected by CV Slide.

ACTIVE mode

In this mode, you can set each step to Active or Inactive.

Inactive steps are removed from the sequence and are skipped during the pattern playback.

Setting a step to Active/Inactive

- 1 Press the **[TRIGGER]** button, or press the **[TRIGGER]** button while holding down the **[SHIFT]** button.
The **[TRIGGER]** button lights up in orange and the 16-pads switches to Trigger mode.
- 2 Hold down the **[ACTIVE]** button and press the pad of the step to set to Active/Inactive.
The **[ACTIVE]** button lights up in orange and the 16-pads switches to Active mode while holding down the pad.
The light of the pad of the step which is set to Inactive turns off.
Pressing the same pad toggles the step Active and Inactive.
- 3 Release the **[ACTIVE]** button.
The 16-pads returns to Trigger mode or CC mode.

INTERPOLATION

By setting each parameter for the steps of the beginning, middle and end points, the unit automatically interpolates parameters for the steps in-between them.

The following parameters can be interpolated using this function.

- PITCH value
- GATE value
- VELOCITY value
- The control values of the controller numbers assigned to the CC1 to CC3 knobs

For the Interpolation function, use the following buttons in the **[INTERPOLATION]** section.

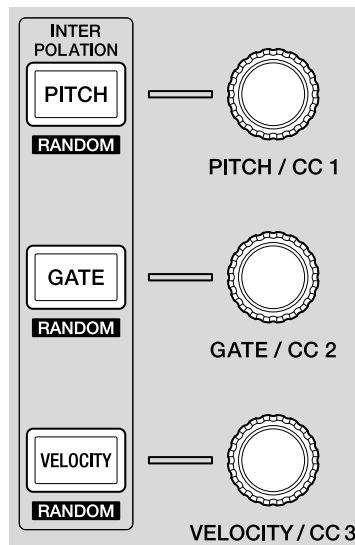

Notes

- The interpolation result varies depending on settings of the Running Direction function (page 95).

- When there are multiple notes for a step, the operation is as follows:
 - PITCH: The PITCH value which is interpolated is applied to Note 1. The PITCH values for Note 2 to 8 are not applied.
 - GATE: GATE value which is interpolated is applied to all notes.
 - VELOCITY: VELOCITY value which is interpolated is applied to all notes.
- For the note applied with interpolation, the OFFSET value is set to 0.

Using INTERPOLATION

- 1 Press the **[PITCH]**, **[GATE]**, or **[VELOCITY]** button.
The pressed button lights up in orange.
 - When Trigger mode is selected at the end, you can interpolate the PITCH, GATE, or VELOCITY value.
 - When CC mode is selected at the end, you can interpolate the control value of CC1, CC2, or CC3.
- 2 Hold down the pad to set the beginning, middle, or end point for the interpolation, and turn the knob at the right of the button pressed in step 1.
The display shows the value of the parameter. The pads where the beginning, middle, and end points were set light up in white.
 - In addition up to 5 points (beginning, end and up to 3 middle points) can be inserted.
 - To delete the beginning, middle, or end point, press the pad where the step including the point is. The light of the pad dims.

Step edit section

(1) Parameters of the beginning, middle, and end points



- 3 Press the same button pressed in step 1.
The unit exits Interpolation mode and the 16-pads returns to the former mode.

RANDOMIZER

In this mode, you can randomly mute/unmute, set the PITCH, GATE, VELOCITY value, or control value for each step of the current pattern.

Using the RANDMIZER function

- 1 Press and hold the **[SHIFT]** button and press the **[ACTIVE]**, **[PITCH]**, **[GATE]** or **[VELOCITY]** button.
 - **[SHIFT]** + **[ACTIVE]** buttons:
All steps are set to Unmute/Mute randomly.
 - When Trigger mode is selected at the end
 - **[SHIFT]** + **[PITCH]** buttons:
The PITCH values for all steps are set randomly.
 - **[SHIFT]** + **[GATE]** buttons:
The GATE values for all steps are set randomly.
 - **[SHIFT]** + **[VELOCITY]** buttons:
The VELOCITY values for all steps are set randomly.
 - When CC mode is selected at the end
 - **[SHIFT]** + **[PITCH]** buttons:
The control value of CC1 for all steps are set randomly.
 - **[SHIFT]** + **[GATE]** buttons:
The control value of CC2 for all steps are set randomly.
 - **[SHIFT]** + **[VELOCITY]** buttons:
The control value of CC3 for all steps are set randomly.
 - The scale set with the Melodic control function is applied for the PITCH value set with Randomizer. For details, refer to “Setting the Scale” (page 87).
 - To set PITCH, GATE, VELOCITY and control values randomly, these setting ranges can be set in advance. For more details, refer to the **[Randomizer]** setting (page 136) in the GLOBAL menu.

HARMONIZER

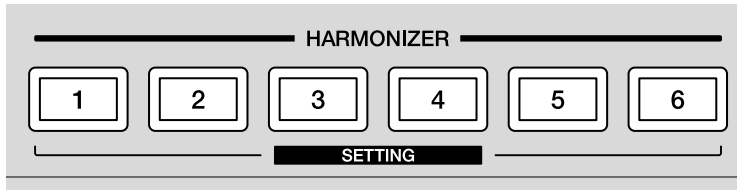

About the HARMONIZER

This function plays chords with the PITCH value of the parameter as the root. When performing by tapping pads in Scale mode or operating the pattern playback, press one of the **[HARMONIZER]** buttons to play chords with the step at the point of the pressed button as the root.

Note

Refer to “HARMONIZER settings” (page 148) to set chords for each of the **[HARMONIZER]** buttons.

Applying the HARMONIZER to a step

A chord can be set to the step parameter.

- 1 Set the 16-pads to Trigger mode (page 47), CV Slide mode (page 65), or CC mode (page 61).
- 2 Hold down a pad of the step to be set with a chord and press one of the **[HARMONIZER]** buttons.
The pressed **[HARMONIZER]** button lights up and the chord type of the button is set to the step.
 - To delete the chord, hold down the pad and press the same button again.

Using the HARMONIZER

The Harmonizer can be used during Scale mode (page 39) or pattern playback (page 26).

Notes

- Any notes triggered by the Harmonizer that are beyond the upper limit of the MIDI note number will not be played back.
- If there are multiple notes in a step, the following will be the root note.
 - The firstly triggered note in the step
 - If multiple notes are triggered at the same time, the note with the lowest PITCH value.

❖ Using the HARMONIZER in SCALE mode

- 1 Hold down one of the **[HARMONIZER]** buttons and tap the 16-pads.

As the pad that is not the root, the chord set on the button is played. While holding down the button, it lights up in red. When the button is released, it lights dimly and the Harmonizer function turns off.

❖ Using HARMONIZER during the pattern playback

- 1 Press one of the **[HARMONIZER]** buttons.

As the note in the playing step is the root, the chord set on the button is played. While holding down the button, it lights up in red. When the button is released, it lights dimly and the Harmonizer function turns off.

COPY/PASTE

If you hold down the **[COPY]** or **[PASTE]** button and press the 16-pads, the following functions can be activated.

- Copying/Pasting for the step
- Copying/Pasting for the pattern
- Copying/Pasting for the note

Copying/Pasting a step

- 1 Press the **[TRIGGER]** button, or hold down the **[SHIFT]** button and press the **[TRIGGER]** button.

The 16-pads switches to Trigger mode or CC mode.

- 2 Hold down the **[COPY]** button and press the pad that you want to copy.

The pad that is copied lights up in blue.

- You can copy multiple steps by holding down the beginning pad, then pressing the end pad all while holding down the **[COPY]** button.

- 3 Hold down the **[PASTE]** button and press the pad to paste to.

The pad that is pasted lights up in blue.

- If you have multiple steps copied, hold down the **[PASTE]** button and press the beginning pad.

Copying/Pasting patterns

- 1 Press the **[PATTERN]** button.
The 16-pads switches to Pattern mode.
- 2 Hold down the **[COPY]** button and press the pad that you want to copy.
The pad that is copied lights up in blue.
- 3 Hold down the **[PASTE]** button and press the pad to paste to.
The pad that is pasted lights up in blue.

Copying/Pasting notes

- 1 Press the **[SCALE]** button or press the **[SCALE]** button while holding down the **[SHIFT]** button.
The 16-pads switches to Scale mode or Chord mode.
You can also use Scale mode or Chord mode to copy the note.
- 2 Hold down the **[COPY]** button and press the pad that you want to copy.
The pad that is copied lights up in blue.
 - If you are copying multiple pads in Scale mode, hold down the **[COPY]** button and press all the pads to copy at the same time.
- 3 Press the **[TRIGGER]** button.
The 16-pads switches to Trigger mode.
- 4 Hold down the **[PASTE]** button and press the pad to paste to.
The pad which is pasted lights up in blue and the note on the copied pad is overwritten.
 - When copying more than one pad, all notes set on the copied pad are overwritten on the pasted pads as chords.

DELETE

If you hold down the **[COPY]** and **[PASTE]** buttons and perform certain operations, the following functions can be activated.

- Deleting the automation (Transpose, Groove Bend, Speed Control, Rhythmic Control) recorded on the sequence
- Initializing the step
- Deleting the pattern
- Deleting the pattern set
- Deleting the note

Deleting the automation recorded on the sequence

- 1 Press the **[COPY]** and **[PASTE]** buttons.
When both buttons are pressed, deleting mode is enabled and all function buttons with automation recorded flashes. The **[AUTOMATION ON]** indicator flashes in the case of Groove Bend. The item on which automation is recorded is highlighted on the display.
- 2 Press one of the buttons for the function to delete the automation or move the **[GROOVE BEND]** slider in the case of Groove Bend. The automation of the pressed button is deleted and the light of the button turns off. The **[AUTOMATION ON]** indicator turns off in the case of Groove Bend.

Initializing a step

- 1 Press the **[TRIGGER]** button, or hold down the **[SHIFT]** button and press the **[TRIGGER]** button.

The 16-pads switches to Trigger mode or CC mode.

- 2 Hold down the **[COPY]** and **[PASTE]** buttons and press the pad of the step you want to initialize.

The step is initialized and the pad lights dimly.

- In Trigger mode, various parameters are initialized as follows.

PITCH value: Note number 60

GATE value: 1.000 step

VELOCITY value: 100

COUNT value: 1

DIVIDE value: 1

Trigger: Mute

Tie: Disabled

CV Slide: Disabled

Active: Active

Harmonizer: Disabled

- In CC mode, various parameters are initialized as follows.

CC1 control value: 0

CC2 control value: 0

CC3 control value: 0

CC4 control value: 0

CC5 control value: 0

CC: Mute

Active: Active

Deleting a pattern

- 1 Press the **[PATTERN]** button.
The 16-pads switches to Pattern mode.
- 2 Hold down the **[COPY]** and **[PASTE]** buttons and press the pad of the pattern you want to delete.
The pattern is deleted and the light of the pad turns off.

Deleting a pattern set

- 1 Hold down the **[SHIFT]** button and press the **[PATTERN]** button.
The 16-pads switches to Pattern Set mode.
- 2 Hold down the **[COPY]** and **[PASTE]** buttons and press the pad of the pattern set you want to delete.
The pattern set is deleted and the light of the pad turns off.

Deleting a note

- 1 Press the **[SCALE]** button.
The 16-pads switches to Scale mode.
- 2 Press the **[▶]** button.
The sequence plays back.
- 3 Hold down the **[COPY]** and **[PASTE]** buttons and press the pad of the PITCH value which you want to delete.
The note triggered in the sequence playback set with the same PITCH value is deleted while the pad is being held down.

STEP SHIFT

This function shifts all of the steps in the current pattern forwards and backwards (including Inactive steps).

- 1 Hold down the **[SHIFT]** button and turn the **[DIVIDE/CC5]** knob. Turn it to the left to shift steps forwards, or turn it to the right to shift steps backwards.
 - When shifting steps forwards, the first step on the first page is changed to the last step on the last page.
 - When shifting steps backwards, the last step on the last page is changed to the first step on the first page.

STEP JUMP

This function can move the playback position to a step of the 16-pads for pattern playback.

- 1 Hold down the **[SHIFT]** button and press one of the 16-pads. The pattern playback position is moved to the step of the pressed pad.

FIXED LENGTH

This function automatically fixes the length of a pattern to a predetermined number of beats.

Toggling FIXED LENGTH

1 Press the **[FIXED LENGTH]** button.

The button lights up and Fixed Length is turned on. When playing to the set length, the playback position is automatically moved to the first step to repeat playback.

- When you press the button again, the button lights up dimly and Fixed Length is turned off.
- When Fixed Length is turned on during playback, this is applied at the first beat of the next bar. The **[FIXED LENGTH]** button flashes until Fixed Length is turned on.

Note

To set Fixed Length, refer to “FIXED LENGTH setting” (page 151).

Phrase arrangement section

SPEED MODULATION function

You can create a unique Groove by fluctuating the playback speed.

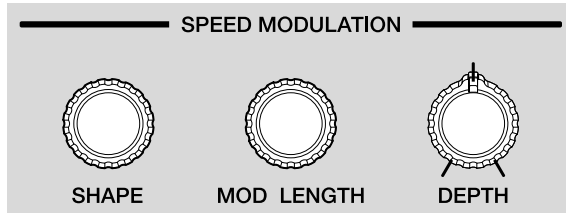

Example: Basic sequence

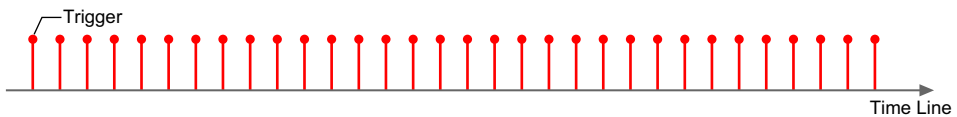

Example: Sequence added with Speed Modulation

(1) When the Depth is [32], (2) When the Depth is [63]

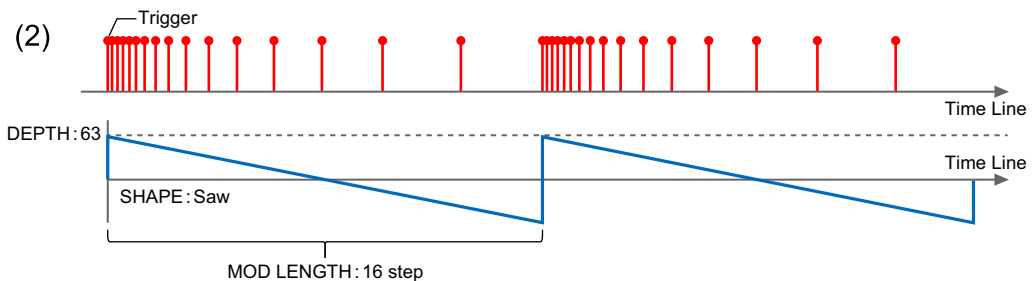
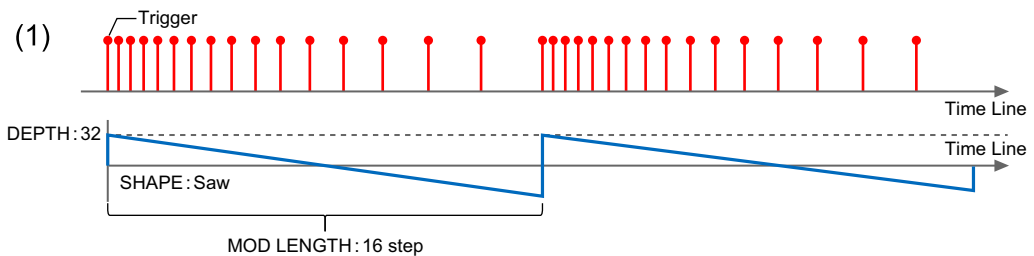

Phrase arrangement section

The Speed Modulation function has the following three settings.

- Shape (page 82)
Turn the **[SHAPE]** knob to select a waveform to be used for the modulation.
- Modulation Length (page 83)
Turn the **[MOD LENGTH]** knob to set the modulation cycle in steps.
- Depth (page 85)
Turn the **[DEPTH]** knob to set the strength of modulation.

SHAPE setting

- 1 Turn the **[SHAPE]** knob to select a waveform to be used for the modulation.

The waveform name before the change and the waveform name after the change are shown on the display.

(1) Waveform before the change, (2) Waveform after the change



- If you do not turn the knob for a period of time, the display returns to the former state.
- The waveform can be selected from the following.

- (1) Triangle1
- (3) Sine
- (5) Saw

- (2) Triangle2
- (4) Cosine
- (6) Square

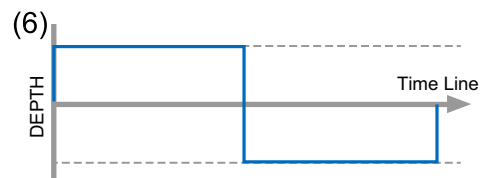
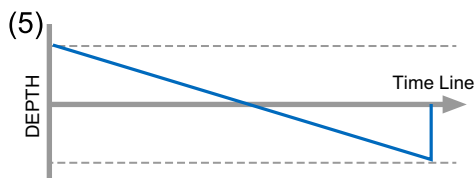
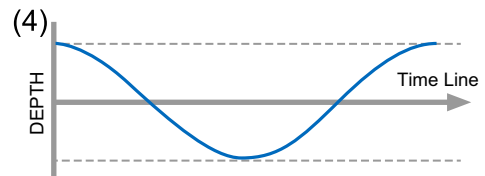
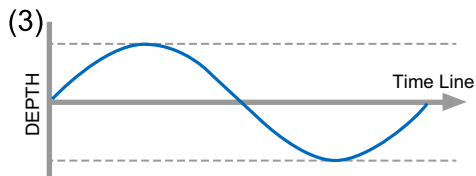
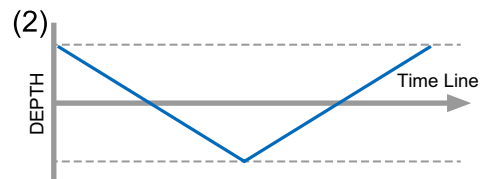
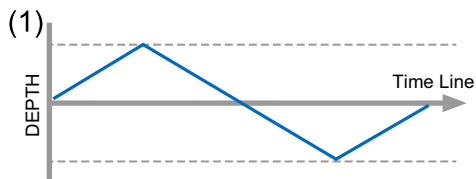

Setting MODULATION LENGTH

- 1 Turn the **[MOD LENGTH]** knob to set the modulation cycle.
The value before the change and the value after the change are shown on the display.
The range can be set in steps from **[2 step]** to **[64 step]**.

(1) Value before the change, (2) Value after the change



- If you do not turn the knob for a period of time, the display returns to the former state.
- Even if the step direction or the pattern length is changed, the set cycle is maintained.

Phrase arrangement section

Example: When turning the **[MOD LENGTH]** knob of the Saw wave to the left or right to change the setting value

(1) **[32 step]**, (2) **[16 step]**, (3) **[8 step]**

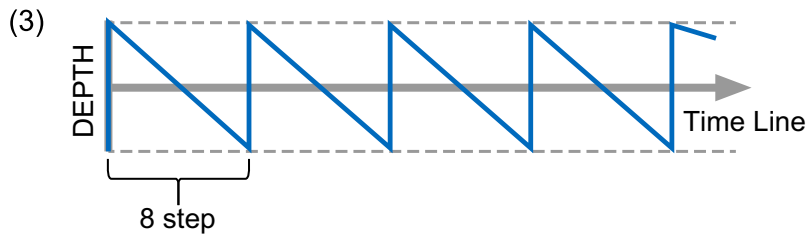
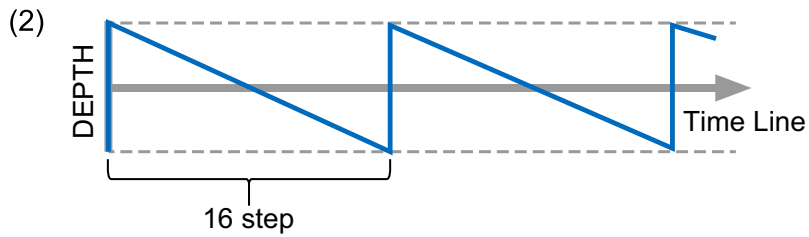
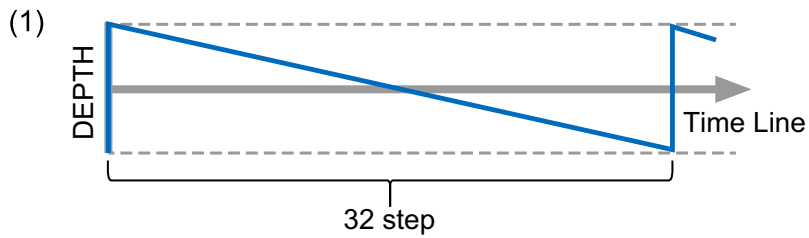

Setting DEPTH

- 1 Turn the **[DEPTH]** knob to change how strongly the modulation affects the pattern.

The value before the change and the value after the change are shown on the display.

(1) Value before the change, (2) Value after the change

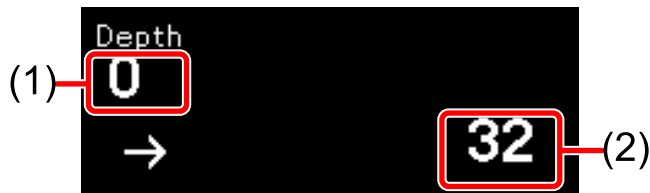

- If you do not turn the knob for a period of time, the display returns to the former state.
- The range of the strength is **[-64]** to **[0]** to **[63]**.
- When the **[Depth]** is set to **[0]**, there will be no modulation added to the pattern.

Example: When turning the **[DEPTH]** knob to the left or right for the Saw wave to change the setting value

(1) **[0]**, (2) **[32]**, (3) **[63]**, (4) **[-32]**, (5) **[-64]**

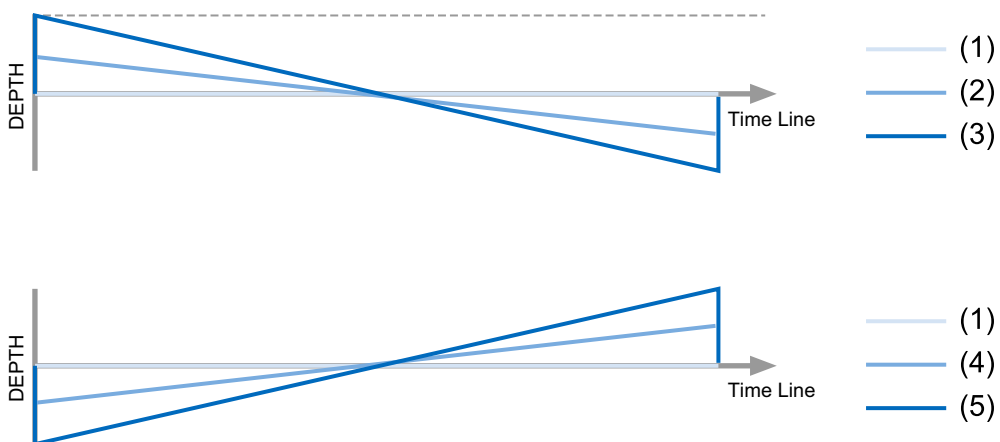

MELODIC CONTROL function

With this function, you can easily change the overall atmosphere of a phrase by changing the scale or key of the pattern or using the Arpeggiator.

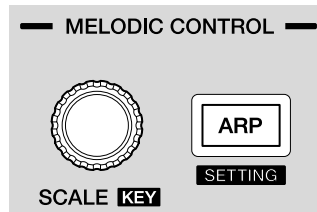

The Melodic Control function has the following three settings.

- Scale settings (page 87)
- Key settings (page 90)

Switch the 16-pads to Scale mode (page 39), set the scale or key for playing. The PITCH value of the note on the current pattern is automatically corrected according to the set scale or key.

Set the key of the scale selected on Scale settings.

- Arpeggiator settings (page 91)

When the Arpeggiator function is enabled, triggered notes are played back as arpeggios during sequence playback. Also, even while the sequence playback is stopped, arpeggio playback is performed with notes triggered by holding the pads.

Arpeggiator settings are as follows.

- Arpeggiator Rate (page 143)
- Arpeggiator Style (page 143)
- Arpeggiator Range (page 143)
- Arpeggiator Gate Length (page 143)

Setting the Scale

1 Turn the **[SCALE]** knob to select a scale name.

The scale name before the change and the scale name after the change are shown on the display.

(1) Scale name before the change, (2) Scale name after the change



- After selecting the scale name which you want to set, the display returns to the former state after a certain time of no operation.

The scales which can be set with the Melodic Control function are as follows.

Scale name	Indications on the display	Constituent note (C as a keynote)
Chromatic	([CHROMA]):	C C# D D# E F F# G G# A A# B
Ionian	([IONIAN]):	C D E F G A B
Dorian	([DORIAN]):	C D Eb F G A Bb
Phrygian	([PHRYGIAN]):	C Db Eb F G Ab Bb
Lydian	([LYDIAN]):	C D E F# G A B
Mixolydian	([MIXOLYDN]):	C D E F G A Bb
Aeolian	([AEOLIAN]):	C D Eb F G Ab Bb
Locrian	([LOCRIAN]):	C Db Eb F Gb Ab Bb
Major Pentatonic	([M. PENTA]):	C D E G A
Minor Pentatonic	([m. PENTA]):	C Eb F G Bb
Whole Tone	([WHOLE T.]):	C D E F# Ab Bb
Diminish	([DIMINISH]):	C D Eb F Gb G# A B
Combination Diminish	([COMBO D]):	C Db Eb bF bG G A Bb

Phrase arrangement section

Altered	([ALTERED]):	C Db D# E F# Ab Bb
Major Blues	([M. BLUES]):	C D D# E G A
Minor Blues	([m. BLUES]):	C D# F F# G A#
Raga Bhairav	([RAGA B.]):	C Db E F G Ab B
Raga Gamanasrama	([RAGA G.]):	C Db E F# G A B
Raga Todi	([RAGA T.]):	C Db Eb F# G Ab B
Hawaiian	([HAWAIIAN]):	C D Eb G A
Ryukyu	([RYUKYU]):	C E F G B
Japanese Miyakobushi	([JP MIYAKO]):	C Db F G Ab
Harmonic minor	([HARMO m.]):	C D Eb F G Ab B

When the scale is changed, the 16-pads on Scale mode (page 39) or the PITCH value of the note on the current pattern are changed as follows.

Scale mode

Example: When changing from the Chromatic scale ([CHROMA]) (1) with C as a keynote to the Minor Blues scale ([m.BLUES]) (2)

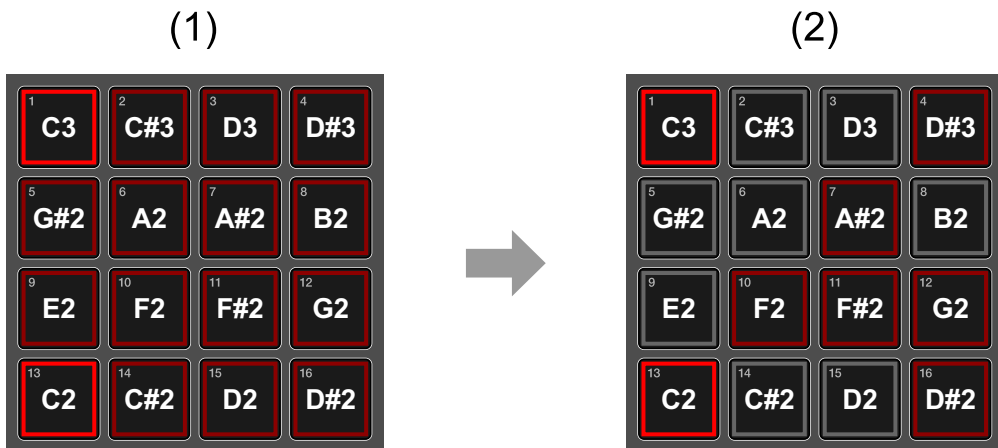

- The lighting state of each pad indicates the following states.
 - Lit in red: Keynote of each scale
 - Lit dimly in red: Constituent note of the scale
 - Off: Note that does not exist in the scale

Phrase arrangement section

Current pattern

Example: When changing from Chromatic scale ([**CHROMA**]) to Minor Blues scale ([**m.BLUES**]) in the key of C.

(1) A pattern made in the Chromatic scale

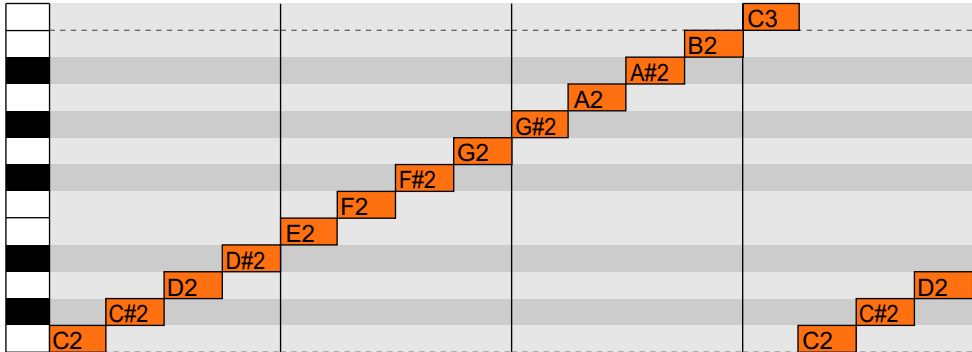

(2) The same pattern as above changed to Minor Blues scale in the key of C

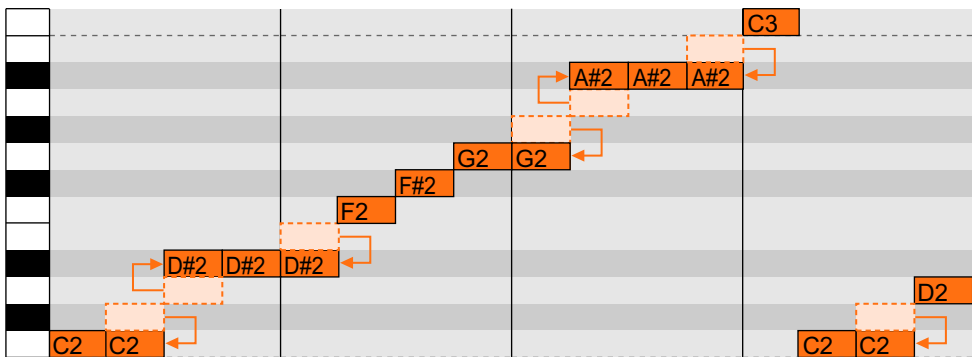

Setting the KEY

- 1 Hold down the **[SHIFT]** button and turn the **[SCALE]** knob to select the key.

The Key before the change and the Key after the change are shown on the display.

(1) Key before the change, (2) Key after the change

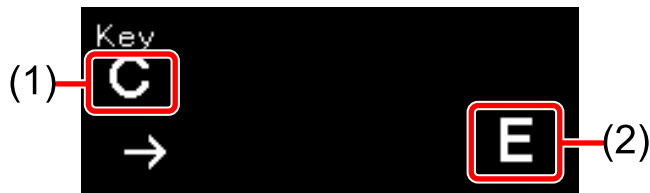

- After selecting the key which you want to set, the display returns to the former state after a certain time of no operation.

When the key is changed, the keynote on Scale mode is changed to the set key as seen in the following example.

Example: When changing the key of Minor Blues from C (1) to E (2)

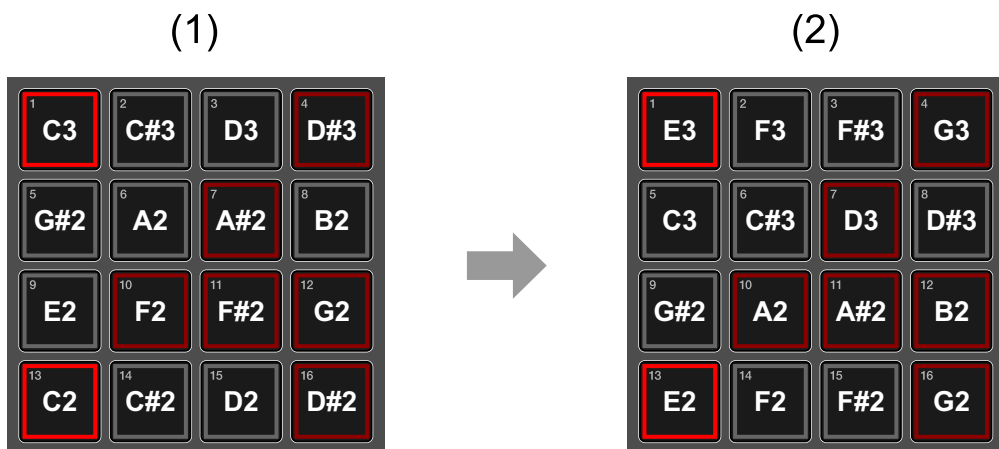

The keynote on the scale of the current pattern is also changed to the set key and the pattern is transposed.

Using the ARPEGGIATOR

When the Arpeggio function is enabled, triggered notes are played back as arpeggios during sequence playback. Also, even while the sequence playback is stopped, arpeggio playback is performed with notes triggered by holding the pads.

❖ Toggling ARPEGGIATOR mode

1 Press the **[ARP]** button.

The **[ARP]** button lights up and Arpeggiator mode is enabled.

- When pressing the button again, the button dims and Arpeggiator mode is disabled.

Note

For setting Arpeggiator, refer to “ARPEGGIATOR settings” (page 142).

GROOVE CONTROL function

For the Swing or Groove Bend function, your own Groove can be created by altering the trigger timing in real-time.

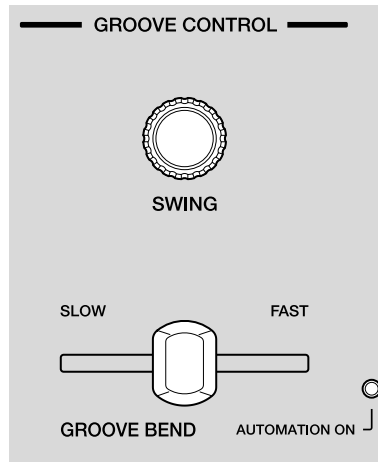

Using SWING

Swing delays the trigger timing and creates various grooves.

- 1 Turn the **[SWING]** knob to set the Swing value.
The value before change and the value after change are shown on the display.
 - The value can be set in percentage from **[0]** % to **[100]** %.

(1) Value before the change, (2) Value after the change



- If the setting value is changed from **[0]** % to **[100]** %, the trigger timing of the even step will be delayed. When it is set to **[0]** %, there is no Swing effect. When it is set to **[100]** %, the trigger timing is offset to the position of 1/32T.

Phrase arrangement section

- If you do not turn the knob for a period of time, the display returns to the former state.

Note

Swing affects only the sequence trigger inside the unit. It does not affect the timing clock output from the unit.

Using GROOVE BEND

You can alter the trigger timing by operating the **[GROOVE BEND]** slider.

Enabling you to apply grooves to the phrase, as if you were playing an actual instrument.

1 Move the **[GROOVE BEND]** slider.

You can intentionally drag triggers by moving the slider to the left and rush by moving the slider to the right.

- According to the operations of the **[GROOVE BEND]** slider, the trigger timing delays 1 step at most.

Phrase arrangement section

Example: Move the **[GROOVE BEND]** slider

(1) Normal trigger timing

(2) Trigger timing shifted by **[GROOVE BEND]**

(3) The period when moving the **[GROOVE BEND]** slider to the left

(4) The period when moving the **[GROOVE BEND]** slider to the right

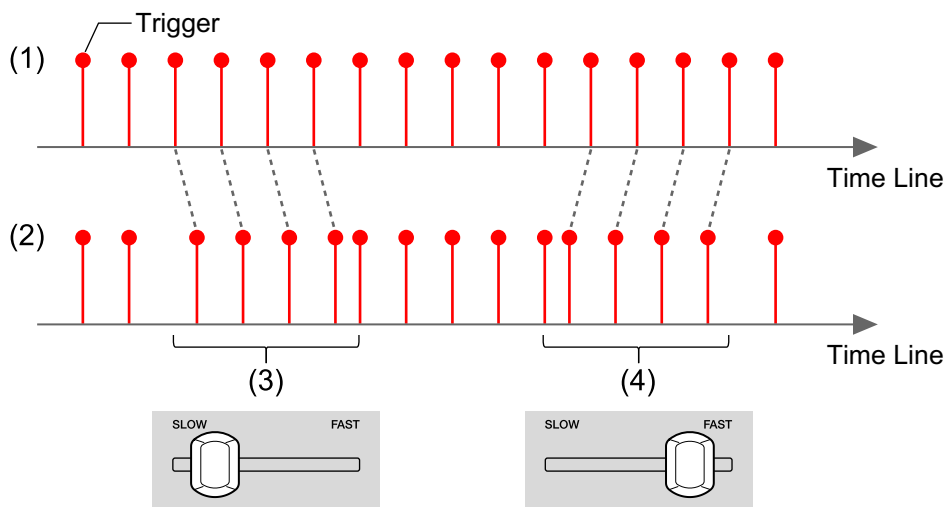

RUNNING DIRECTION function

A new phrase can be easily created from a pattern by changing the playback direction of the sequence on the 16-pads.

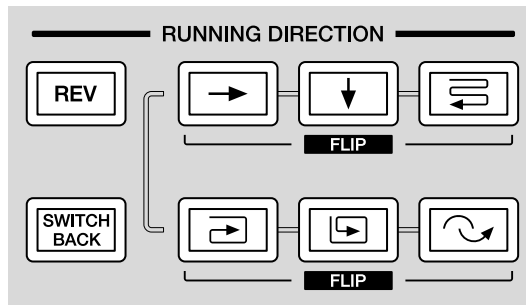

Setting the direction of the sequence

- 1 Press the [→], [↓], [↔], [↵], [↶], or [↷] button.

The pressed button lights up in orange, and the direction of the sequence is changed as in “Button and step progress” below.

- When holding down the [SHIFT] button and pressing each button, the direction mirrors horizontally.

Button and step progress

→ button

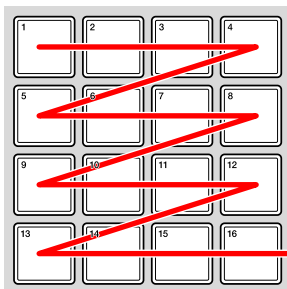

[SHIFT] button + → button

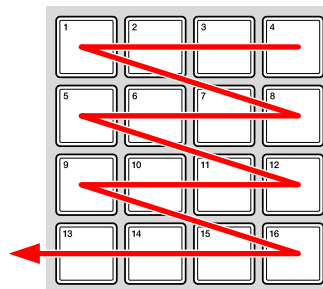

Phrase arrangement section

↻ button

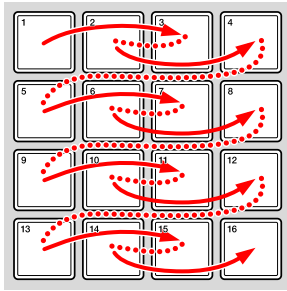

[SHIFT] button + ↻ button

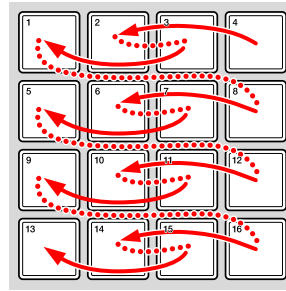

Reversing step progress (REVERSE)

Reverse the direction which is set by “Setting the direction of the sequence” (page 95).

1 Press the **[REV]** button.

The button lights up in yellow-green, and the direction is reversed.

- To change the direction back to the original direction, press the button again to turn off the light.

Example: Step progress with the **[→]** button

REV off

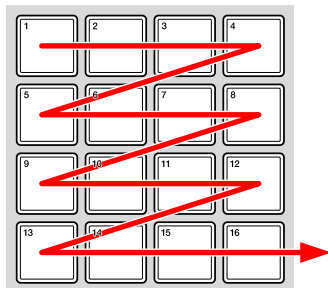

REV on

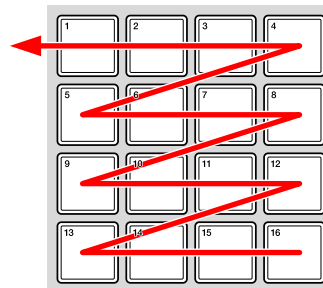

Moving the step back and forth (SWITCH BACK)

The progress moves back and forth between the first and last steps of the pattern according to the direction which is set by “Setting the direction of the sequence” (page 95).

- 1 Press the **[SWITCH BACK]** button.

The button lights up in yellow-green, and the progress moves back and forth between the first and last steps of the pattern.

- To turn off this setting, press the button again to turn off the light.

Example: Step progress with the **[→]** button

SWITCH BACK off

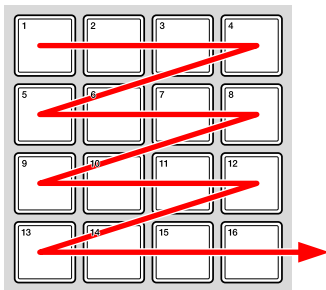

SWITCH BACK on

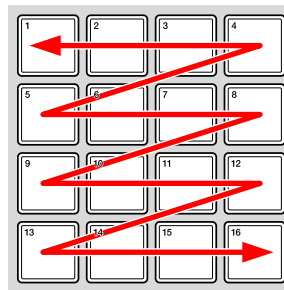

SPEED CONTROL function

Change the playback speed of the current pattern in real-time to create an elaborate phrase intuitively.

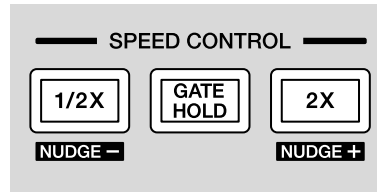

Halving playback speed of the current pattern

- 1 Hold down the **[1/2X]** button during the sequence playback. While holding down the button, the button lights up, and the speed of the current pattern is halved.
 - While holding down the button, the playback speed changes by maintaining the previous playback position in the back ground. When releasing the button, the light of the button turns off, the playback speed returns to normal, and playback starts from the previous playback position.
 - When the playback speed is dropped to half, the gate length of each note is doubled.
 - The BPM is not changed.

Using GATE HOLD of the current pattern

The triggered note output is held so that your performance changes as if the phrase stopped.

- 1 Hold down the **[GATE HOLD]** button during the sequence playback. While holding the button, the button lights up, and the triggered note output is held.

Phrase arrangement section

- While holding down the button, the triggered note output is held by maintaining the previous playback position in the background. When releasing the button, the light of the button turns off, Gate Hold is cancelled and the playback starts from the previous playback position.
- The BPM is not changed.

Note

Depending on the settings of connected external equipment, the output sound may not be retained.

Doubling the playback speed of the current pattern

- 1 Hold down the **[2X]** button during the sequence playback.
When holding the button, the button lights up, and the speed of the current pattern is doubled.
 - While holding down the button, the playback speed changes by maintaining the previous playback position in the background. When releasing the button, the light of the button turns off, the playback speed returns to normal, and playback starts from the previous playback position.
 - The BPM is not changed.

Operating NUDGE

By temporarily increasing or decreasing the BPM of this unit, you can manually beat match internal sequences or beat match with external equipment.

- 1 Hold down the **[SHIFT]** button during the sequence playback, and hold down the **[2X]** button or **[1/2]** button.
While holding the **[2X]** button, the BPM will be faster. While holding the **[1/2]** button, the BPM will be slow.
 - When the button is released, the BPM returns to the former one.
 - When operating Nudge, the BPM changes up to ± 5 BPM in a second.
 - It applies to all tracks.

RHYTHMIC CONTROL function

You can easily create fill-ins and new phrases by looping a part of a pattern or changing the probability of triggers.

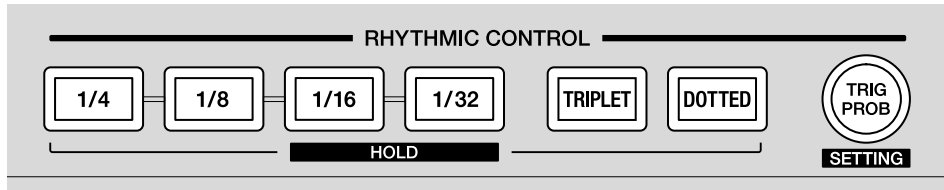

Looping parts of a pattern

This function loops playback at the point of the pattern being played.

- 1 During the pattern playback, hold down the **[1/4]**, **[1/8]**, **[1/16]**, or **[1/32]** button.

While holding the button, the button lights up, and the loop playback is repeated.

- The loop length of each button is as follows.
 - [1/4]** button: 4 steps
 - [1/8]** button: 2 steps
 - [1/16]** button: 1 step
 - [1/32]** button: 1/2 step
- When the button is released, the button light dims, and the function is cancelled.
- While holding down the button, the loop playback is repeated with the playback point (step) retained in the background. When the button is released, the button light dims, the loop playback is cancelled, and the playback continues from the former point.
- While holding down the **[SHIFT]** button and pressing one of the buttons, the loop playback is repeated even if the button is released (Hold function). While holding down the button, press one of buttons to cancel the loop playback.

Phrase arrangement section

2 During step 1, hold down the **[TRIPLET]** or **[DOTTED]** button.

The loop playback is repeated at $2/3$ times the step length while **[TRIPLET]** is being held down and at $3/2$ times while **[DOTTED]** is being held down.

- The loop length by each combination of the **[TRIPLET]** or **[DOTTED]** button is shown as follows.

[1/4] + [DOTTED]: 6 steps

[1/4]: 4 steps

[1/4] + [TRIPLET]: $8/3$ steps

[1/8] + [DOTTED]: 3 steps

[1/8]: 2 steps

[1/8] + [TRIPLET]: $4/3$ steps

[1/16] + [DOTTED]: $3/2$ steps

[1/16]: 1 step

[1/16] + [TRIPLET]: $2/3$ step

[1/32] + [DOTTED]: $3/4$ step

[1/32]: $1/2$ step

[1/32] + [TRIPLET]: $1/3$ step

- The loop length may be different from the above depending on the setting of the COUNT value.
- When the **[TRIPLET]** or **[DOTTED]** button is released, the button light dims and the effect is cancelled.
- When you press the **[TRIPLET]** or **[DOTTED]** button while holding down the **[SHIFT]** button, the effect will continue even if you release the button (HOLD function). At this time, the **[1/4]**, **[1/8]**, **[1/16]**, and **[1/32]** buttons are also held at the same time.

If you press the **[TRIPLET]** button or **[DOTTED]** button during HOLD, the effect is cancelled.

TRIG PROB (Trigger Probability)

You can set the probability of triggers in a pattern. According to the set probability, the trigger for each step will randomly be enabled or disabled.

❖ **Toggling TRIG PROB**

1 Press the **[TRIG PROB]** button.

The button lights up, and the Trigger Probability function is turned on.

- Press the button again to dim the light and turn off the Trigger Probability function.

Note

For setting the trigger probability, refer to “TRIG PROB (Trigger Probability) settings” (page 144).

Global section

UNDO

You can undo specific operations of the unit and restore the former state. The unit can record up to 16 past operations and restore to one of the states.

The following operation can be undone.

- Adding changes to a sequence
- Speed Modulation operation
- Scale and Key setting
- Arpeggiator setting
- Swing setting
- Running Direction setting
- Trigger Probability setting
- Fixed Length setting

1 Hold down the **[SHIFT]** button and press the **[●]** (record) button.

Past operations are shown on the display.

(1) History number, (2) Track number, (3) Pattern number, (4) Operation

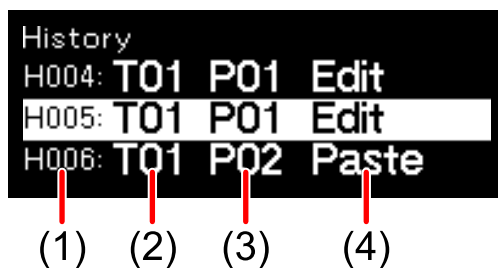

- Hold the **[SHIFT]** button to stay in the History menu.
- The operations indicate the following states.
 - Edit: When any changed is added to the pattern
 - Paste: When a copied pattern is pasted
 - Delete: A pattern is deleted
 - Random: When Randomizer is used

2 Turn the rotary selector to select a history number you want to restore.

The selected history number is highlighted. Once you select a history point, the indications of the buttons and pads are restored accordingly.

- When you press the **[●]** (record) button while holding the **[SHIFT]** button, you move back one history.

TIME WARP

The unit auto records all the internal track information in the background, allowing you to playback and save previously played patterns as new patterns.

1 Press the **[TIME WARP]** button.

The button lights up in white and Time Warp mode is enabled. The display shows the pattern length and preview starting point.

- Timing when switching to Time Warp mode is the first beat of the next bar. If the **[TIME WARP]** button is pressed while playing back a bar, the unit will wait for the down beat of the next bar (the **[TIME WARP]** button flashes), and then enters Time Warp mode (the **[TIME WARP]** button lights up).
- The pads that light up brightly are in the preview range. The dim pads can be selected to start the preview. The preview cannot be started with pads that do not light up.
- The pattern cannot be changed while in Time Warp mode.
- Up to 256 steps (16 Bar) of performance information can be auto recorded inside the unit. Performance information older than 256 steps is overwritten with the new ones.
- To exit Time Warp mode, press the **[TIME WARP]** button so that the button light dims.

2 Turn the rotary selector to select a pattern length.

You can set the pattern length to preview. The setting value can be selected from **[1 bar]**, **[2 bars]**, **[3 bars]**, and **[4 bars]**.

- The length of the pattern will be the length when a new pattern is saved.

3 Press the desired pad to start previewing.

The unit plays the loop with the specified pattern length from the pad that was pressed.

- The pattern being previewed restarts each time a pad is pressed.
- To stop previewing, press the **[■]** (stop) button.
- The length of one pad is 1 Bar.

- Pad 1 is in the oldest starting position of the saved patterns and pad 16 is in the newest one.

- (1) The pattern length to preview
- (2) The position where the preview starts

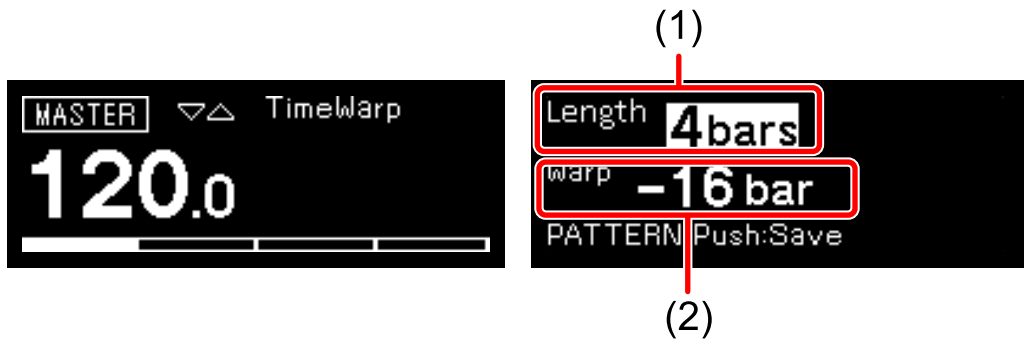

4 Press the **[PATTERN]** button.

The button lights up in green and the 16-pads shows the pattern state of the current track. The 16-pads of the current pattern lights up brightly. The pads with saved patterns are dimly lit. The pads do not light up when there are no saved patterns.

5 Press the desired pad to save the pattern being previewed to.

The pattern is saved and the pressed pad lights up.

- A pattern cannot be saved to a pad with the current pattern.
- To return to Time Warp mode without saving the pattern, press the **[PATTERN]** button again so that the button light dims.

Changing the settings

You can change the unit's settings by either using the GLOBAL menu or the buttons, depending on the settings.

GLOBAL settings

Press the **[GLOBAL]** button to enter the GLOBAL menu.

Setting item list

The figures in parentheses indicate reference pages.
The default setting is shown with *.

❖ [Project] setting (22)

Create New (22)	-
Open(recent) (23)	-
Open(by creation) (23)	-
Open(by name) (23)	-
Save (24)	-
Save As (24)	-
Rename & Save (25)	-
Delete (25)	-

Changing the settings

❖ [Brightness] setting (116)

Display (116)	1, 2* to 4
Buttons Full Lit (116)	1 to 4*, 5
Pads Full Lit (116)	1 to 3*, 4
Pads Dim Lit (116)	1 to 3*, 4

❖ [Pad] setting (117)

Velocity (117)	Disable, Enable*
Velocity Curve (117)	Soft 3, Soft 2*, Soft 1, Linear, Hard
Velocity Threshold (117)	Low 4 to Normal* to High 11
Velocity Sensitivity (117)	Light 11 to Normal* to Heavy 4

❖ [CV/GATE OUT] setting (118)

CV/GATE1 From (118)	Disable*, MIDI Ch.1 to MIDI Ch.16, USB Ch.1 to USB Ch.16
CV/GATE2 From (118)	Disable*, MIDI Ch.1 to MIDI Ch.16, USB Ch.1 to USB Ch.16

Changing the settings

❖ [CV] setting (119)

CV1 Range (119)	Hz/V 8V, V/Oct 1V, V/Oct 2V, V/Oct 5V*, V/Oct 10V, V/Oct -5V
CV1 Ref. Note (120)	<ul style="list-style-type: none"> • When [Middle C] of the [Etc] setting is set to [C3]: C-2 to C1* to C6 • When [Middle C] of the [Etc] setting is set to [C4]: C-1 to C2* to C7 • When [Middle C] of the [Etc] setting is set to [C5]: C0 to C3* to C8
CV2 Range (121)	Hz/V 8V, V/Oct 1V, V/Oct 2V, V/Oct 5V*, V/Oct 10V, V/Oct -5V
CV2 Ref. Note (121)	<ul style="list-style-type: none"> • When [Middle C] of the [Etc] setting is set to [C3]: C-2 to C1* to C6 • When [Middle C] of the [Etc] setting is set to [C4]: C-1 to C2* to C7 • When [Middle C] of the [Etc] setting is set to [C5]: C0 to C3* to C8

❖ [GATE] setting (122)

GATE1 Mode (122)	S-Trigger, V-Trigger 5V*, V-Trigger 10V
GATE1 Polarity (123)	-, +*
GATE2 Mode (123)	S-Trigger, V-Trigger 5V*, V-Trigger 10V
GATE2 Polarity (123)	-, +*

Changing the settings

❖ [Sync Common] setting (124)

Sync Source (124)	DIN MIDI, USB MIDI, DIN SYNC, CLOCK, Internal*
Master Clock Mode (124)	Disable, Enable*

❖ [DIN SYNC] setting (125)

OUT1 Sync Mode (125)	Sync24*, Sync48
OUT1 Cont/Rst Start (126)	Disable*, Enable
OUT2 Mode (126)	IN*, OUT
OUT2 Sync Mode (126)	Sync24*, Sync48
OUT2 Cont/Rst Start (127)	Disable*, Enable

❖ [CLOCK] setting (128)

OUT Sync Mode (128)	1ppqn, 2ppqn, 4ppqn, 24ppqn*, 48ppqn
OUT Polarity (129)	-, +*
IN Sync Mode (129)	1step, 1ppqn, 2ppqn, 4ppqn, 24ppqn*, 48ppqn, Gate
IN Polarity (131)	-, +*

❖ [MIDI IN] setting (132)

Sync (132)	Disable, Receive*
Start/Stop (132)	Disable, Receive*
Rec Channel (132)	Disable, MIDI Ch.All*, MIDI Ch.1 to MIDI Ch.16, USB Ch.All, USB Ch.1 to USB Ch.16

Changing the settings

❖ [MIDI OUT] setting (133)

OUT1 Mode (133)	MIDI OFF, OUT*, OUT+MIDI IN, OUT+USB IN
OUT1 Sync (133)	Disable, Send*
OUT1 Start/Stop (133)	Disable, Send*
OUT2 Mode (134)	MIDI OFF, OUT, OUT+MIDI IN, OUT+USB IN, THRU (MIDI IN)*, THRU (USB IN)
OUT2 Sync (134)	Disable, Send*
OUT2 Start/Stop (134)	Disable, Send*
USB Sync (134)	Disable, Send*
USB Start/Stop (135)	Disable, Send*

Changing the settings

❖ [Randomizer] setting (136)

Pitch Min (136)	<ul style="list-style-type: none"> • When [Middle C] of the [Etc] setting is set to [C3]: C-2 to C3* to G8 • When [Middle C] of the [Etc] setting is set to [C4]: C-1 to C4* to G9 • When [Middle C] of the [Etc] setting is set to [C5]: C-0 to C5* to G10
Pitch Max (136)	<ul style="list-style-type: none"> • When [Middle C] of the [Etc] setting is set to [C3]: C-2 to C4* to G8 • When [Middle C] of the [Etc] setting is set to [C4]: C-1 to C5* to G9 • When [Middle C] of the [Etc] setting is set to [C5]: C-0 to C6* to G10
Gate Min (136)	0.125 Steps* to 16 Steps
Gate Max (136)	0.125 Steps to 1 Step* to 16 Steps
Velocity Min (137)	0 to 60* to 127
Velocity Max (137)	0 to 100* to 127
CC Min (137)	0* to 127
CC Max (137)	0 to 127*

Changing the settings

❖ [Etc] setting (138)

Middle C (138)	C3, C4*, C5
Auto Power Off (138)	Disable, Enable*
Step Preview (138)	Disable, Enable*, Ena(Mute Cur Tr), Ena(Mute All Tr), Ena(Stop/ Pause)
Reset All Settings (139)	-
Restore Demo (139)	-
System Info (139)	-

Operating the GLOBAL menu

- 1 Press the **[GLOBAL]** button.

The GLOBAL menu is shown on the display.



- 2 Turn the rotary selector to select a setting and press it.

The highlight moves to the value of the selected item.

The display shows the values before and after the change.

- Press the **[BACK]** button to return to the previous indication.
- You can jump to the setting category by holding down the **[GLOBAL]** button and pressing the 16-pads.

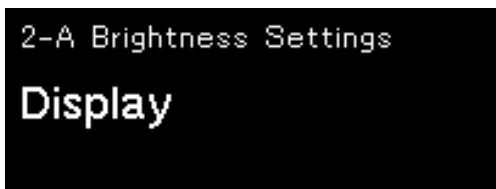

- 3 Turn the rotary selector to change the setting value and press it.

The setting value is determined.

- To cancel, press the **[BACK]** button instead of pressing the rotary selector.

- 4 Press the **[BACK]** button or the **[GLOBAL]** button.

The GLOBAL menu is cancelled, and then the display returns to the former state.

[Brightness] setting

The default setting is shown with *.

❖ **Display**

Setting value: 1, 2* to 4

Adjust the brightness of the display. The larger the setting value is, the brighter the display becomes.

❖ **Buttons Full Lit**

Setting value: 1 to 4*, 5

Set the brightness of the buttons. The larger the setting value is, the brighter the buttons become.

❖ **Pads Full Lit**

Setting value: 1 to 3*, 4

Set the brightness of the 16-pads when the 16-pads are fully lit. The larger the setting value is, the brighter the pads become.

❖ **Pads Dim Lit**

Setting value: 1 to 3*, 4

Set the brightness of the 16-pads when the 16-pads are dimly lit. The larger the setting value is, the brighter the pads become.

[Pad] setting

The default setting is shown with *.

❖ **Velocity**

Setting value: Disable, Enable*

Set VELOCITY to Disable or Enable. When it is set to Disable, the VELOCITY value is fixed to 127 no matter how hard the 16-pads are tapped.

❖ **Velocity Curve**

Setting value: Soft 3, Soft 2*, Soft 1, Linear, Hard

Sets the strength required to tap the 16-pads and volume characteristics.

❖ **Velocity Threshold**

Setting value: Low 4 to Normal* to High 11

Sets the strength required to achieve minimum velocity when tapping the 16-pads.

❖ **Velocity Sensitivity**

Setting value: Light 11 to Normal* to Heavy 4

Sets the strength required to achieve maximum velocity when tapping the 16-pads.

[CV/GATE OUT] setting

You can set the source terminal and channel for MIDI to CV/GATE conversion.

The default setting is shown with *.

❖ **CV/GATE1 From**

Setting value: Disable*, MIDI Ch.1 to MIDI Ch.16, USB Ch.1 to USB Ch.16

Set the input terminal and input channel of MIDI signals output to the **[CV OUT1]** terminal and **[GATE OUT1]** terminal after CV/GATE conversion.

❖ **CV/GATE2 From**

Setting value: Disable*, MIDI Ch.1 to MIDI Ch.16, USB Ch.1 to USB Ch.16

Set the input terminal and input channel of MIDI signals output to the **[CV OUT2]** terminal and **[GATE OUT2]** terminal after CV/GATE conversion.

[CV] setting

You can change the settings of the following terminals.
The default setting is shown with *.

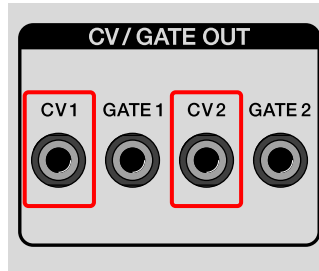

❖ CV1 Range

Setting value: Hz/V 8V, V/Oct 1V, V/Oct 2V, V/Oct 5V*, V/Oct 10V, V/Oct -5V

Set the **[CV OUT1]** terminal CV output method and output voltage range.

Check the CV input specification of the connected equipment and select an appropriate value.

- Hz/V 8V:
Hz/V method, CV output represents an octave of pitch by doubling voltage.
The output voltage range is from 1V to 8V (3 octaves).
- V/Oct 1V:
V/Oct method, 1V represents one octave.
The output voltage range is from 0V to 1V (1 octave).
- V/Oct 2V:
V/Oct method, 1V represents one octave.
The output voltage range is from 0V to 2V (2 octaves).
- V/Oct 5V:
V/Oct method, 1V represents one octave.
The output voltage range is from 0V to 5V (5 octaves).

Changing the settings

- **V/Oct 10V:**
V/Oct method, 1V represents one octave.
The output voltage range is from 0V to 10V (10 octaves).
- **V/Oct -5V:**
V/Oct method, 1V represents one octave.
The output voltage range is from -5V to 5V (+/-5 octaves).
Used to control the Cut-off frequency of filters on modular Synthesizers.

❖ **CV1 Ref. Note**

The setting values are as follows.

- When **[Middle C]** of the **[Etc]** setting is set to **[C3]**: C-2 to C1* to C6
- When **[Middle C]** of the **[Etc]** setting is set to **[C4]**: C-1 to C2* to C7
- When **[Middle C]** of the **[Etc]** setting is set to **[C5]**: C0 to C3* to C8

Set the note for setting output voltage of the **[CV OUT1]** terminal to 0 V. This setting is available when the **[CV1 Range]** setting is in the V/Oct method.

Notes

- Note range of the **[CV OUT1]** terminal is determined according to the **[CV1 Range]** and **[CV1 Ref. Note]** setting. If a note beyond the note range is played, either the of lower or higher limit on the output voltage range set in **[CV1 Range]** is output. The note range of the **[CV OUT2]** terminal is determined according to the **[CV2 Range]** and **[CV2 Ref. Note]** setting.
Example: When the **[CV1 Range]** setting is **[V/Oct 2V]** and the **[CV1 Ref. Note]** setting is **[C2]**, the note range is C2 to C4. If a note lower than C2 is played, 0 V of voltage is output and if a note higher than C4 is played, 2V of voltage is output. Both are from **[CV OUT1]**.
- When the setting of **[CV1 Range]** or **[CV2 Range]** is in the Hz/V method, the output voltage range of the **[CV OUT1]** or **[CV OUT2]** terminal is fixed between 1V to 8V. The note range is C3 to C6 (2 octaves) when **[Middle C]** of the **[Etc]** setting is **[C4]**.

❖ CV2 Range

Setting value: Hz/V 8V, V/Oct 1V, V/Oct 2V, V/Oct 5V*, V/Oct 10V, V/Oct -5V

Set the **[CV OUT2]** terminal CV output method and output voltage range.

Check the CV input specification of the connected equipment and select an appropriate value. For details on the setting value, refer to “CV1 Range” (page 119).

❖ CV2 Ref. Note

The setting values are as follows.

- When **[Middle C]** of the **[Etc]** setting is set to **[C3]**: C-2 to C1* to C6
- When **[Middle C]** of the **[Etc]** setting is set to **[C4]**: C-1 to C2* to C7
- When **[Middle C]** of the **[Etc]** setting is set to **[C5]**: C0 to C3* to C8

Set the note for setting output voltage of the **[CV OUT2]** terminal to 0 V. This setting is available when the **[CV2 Range]** setting is in the V/Oct method.

For details, refer to “Notes” of “CV1 Ref. Note” (page 120).

[GATE] setting

You can change the settings of the following terminals.
The default setting is shown with *.

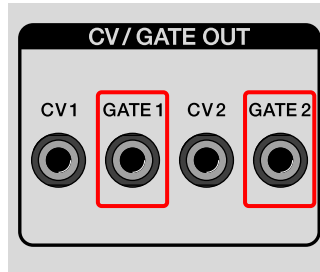

❖ GATE1 Mode

Setting value: S-Trigger, V-Trigger 5V*, V-Trigger 10V
Set the output method of the **[GATE OUT1]** terminal.

- S-Trigger:
Short circuit trigger or negative trigger method
The output will be one of the open (open), or short (short-circuit).
Usable in applications such as connecting the foot pedal
- V-Trigger 5V:
Voltage trigger or positive trigger method
The output voltage will be 5 V or 0 V.
- V-Trigger 10V:
Voltage trigger or positive trigger method
The output voltage will be 10 V to 12 V or 0 V.

❖ GATE1 Polarity

Setting value: –, +*

Set the polarity of the **[GATE OUT1]** terminal. – is a negative logic and + is a positive logic.

Check the Gate input specification of the connected equipment and select an appropriate value.

Set the operation state of the terminal during Gate on and Gate off with **[GATE1 Mode]** (page 122).

- –: Negative logic (active low) output
0 V or short (short-circuit) in the gate-on. 5V, 10V, or open (open) in the gate-off
- +: Positive logic (active low) output
5V, 10V or open (open) in the gate-on. 0 V or short (short-circuit) in the gate-off

❖ GATE2 Mode

Setting value: S-Trigger, V-Trigger 5V*, V-Trigger 10V

Set the output method of the **[GATE OUT2]** terminal.

Check the Gate input specification of the connected equipment and select an appropriate value. For details on the setting value, refer to “GATE1 Mode” (page 122).

❖ GATE2 Polarity

Setting value: –, +*

Set the polarity of the **[GATE OUT2]** terminal. – is a negative logic and + is a positive logic.

Check the Gate input specification of the connected equipment and select an appropriate value.

Set the operation state of the terminal during Gate on and Gate off with **[GATE2 Mode]**.

For details on the setting value, refer to “GATE1 Polarity” (page 123).

[Sync Common] setting

Set the common items on the timing clock.

The default setting is shown with *.

❖ **Sync Source**

Setting value: DIN MIDI, USB MIDI, DIN SYNC, CLOCK, Internal*

Set the clock source to be a master.

Note

If you change a setting value during sequence playback, the sequence playback will stop.

❖ **Master Clock Mode**

Setting value: Disable, Enable*

Set the timing clock of the **[MIDI]** terminal and **[CLOCK]** terminal.

When **[Sync Source]** is set to Internal, set the timing clock output to Disable/Enable in the stop/pause state.

- Disable: The timing clock is output in the stop/pause state.
- Enable: The timing clock is output ordinarily.

Note

Regardless of the **[Master Clock Mode]** setting, the timing clock is always output from the **[DIN SYNC]** terminal.

[DIN SYNC] setting

You can change the settings of the following terminals.
The default setting is shown with *.

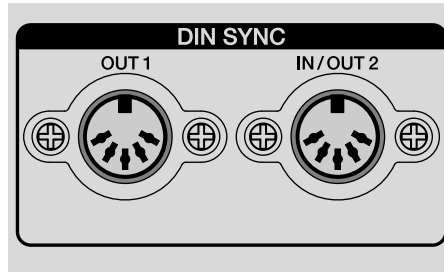

❖ OUT1 Sync Mode

Setting value: Sync24*, Sync48

Set the timing clock rate from the **[DIN SYNC OUT1]** terminal.

Check the specification of the connected equipment and select an appropriate value.

- Sync24:
Timing clock rate of 24ppqn (Pulse Per Quarter Note)
The length of one quarter note is represented by 24 pulses.
- Sync48:
Timing clock rate of 48ppqn (Pulse Per Quarter Note)
The length of one quarter note is represented by 48 pulses.

📌 Note

If you change the DIN SYNC setting during sequence playback, the sequence playback will stop.

❖ **OUT1 Cont/Rst Start**

Setting value: Disable*, Enable

Set the Continue/Reset Start signal output to Disable/Enable from the **[DIN SYNC OUT1]** terminal.

Check the specification of the connected equipment and select an appropriate value.

- **Disable:** The Continue/Reset Start signal is not output when playback starts.
Only the timing clock and Start/Stop signal is output from the **[DIN SYNC OUT1]** terminal.
- **Enable:** The Continue/Reset Start signal is output when playback starts.

For details on Continue Start and Reset Start signals, refer to “Synchronizing the unit and an external DIN SYNC compatible device to play” (page 160).

❖ **OUT2 Mode**

Setting value: IN*, OUT

Set the **[DIN SYNC IN/OUT2]** terminal to the input terminal (**[IN]**) or output terminal (**[OUT]**).

❖ **OUT2 Sync Mode**

Setting value: Sync24*, Sync48

Set the timing clock rate signal to/from the **[DIN SYNC IN/OUT2]** terminal. Check the specification of the connected equipment and select an appropriate value. For details on the setting value, refer to “OUT1 Sync Mode” (page 125).

Note

If you change the DIN SYNC setting during sequence playback, the sequence playback will stop.

❖ **OUT2 Cont/Rst Start**

Setting value: Disable*, Enable

Set the Continue/Reset Start signal output to Disable/Enable from the **[DIN SYNC IN/OUT2]** terminal.

Check the specification of the connected equipment and select an appropriate value. For details on the setting value, refer to “OUT1 Cont/Rst Start” (page 126).

[CLOCK] setting

You can change the settings of the following terminals.

The default setting is shown with *.

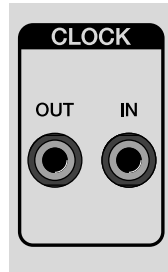

❖ OUT Sync Mode

Setting value: 1ppqn, 2ppqn, 4ppqn, 24ppqn*, 48ppqn

Set the timing clock rate from the **[CLOCK OUT]** terminal.

Check the specification of the connected equipment and select an appropriate value.

- 1ppqn:
Timing clock rate of 1ppqn (Pulse Per Quarter Note)
Outputs 1 pulse at the timing of one beat (one quarter note).
- 2ppqn:
Timing clock rate of 2ppqn (Pulse Per Quarter Note)
Outputs 1 pulse at the timing of 1/2 beat (Eighth note).
- 4ppqn:
Timing clock rate of 4ppqn (Pulse Per Quarter Note)
Outputs 1 pulse at the timing of 1/4 beat (16 minute note).
- 24ppqn:
Timing clock rate of 24ppqn (Pulse Per Quarter Note)
24 pulse timing clock is the length of one quarter note.
- 48ppqn:
Timing clock rate of 48ppqn (Pulse Per Quarter Note)
48 pulse timing clock is the length of one quarter note.

❖ OUT Polarity

Setting value: -, +*

Set the polarity of the **[CLOCK OUT]** terminal. - is falling and + is rising.

Check the specification of the connected equipment and select an appropriate value.

- -:
Select when the connected equipment triggers the pulse of the timing clock in falling (negative edge trigger).
- +:
Select when the connected equipment triggers the pulse of the timing clock in rising (positive edge trigger).

❖ IN Sync Mode

Setting value: 1step, 1ppqn, 2ppqn, 4ppqn, 24ppqn*, 48ppqn, Gate
Set the timing clock rate from the **[CLOCK IN]** terminal.

Check the specification of the connected equipment and select an appropriate value.

- 1step:
Timing clock rate of 1 Pulse Per Step
A pattern is advanced by one step when 1 pulse is input to the timing clock.
- 1ppqn:
Timing clock rate of 1ppqn (Pulse Per Quarter Note)
1 pulse of the input timing clock is counted as one beat (one quarter note).
- 2ppqn:
Timing clock rate of 2ppqn (Pulse Per Quarter Note)
1 pulse of the input timing clock is counted as 1/2 beat (Eighth note).
- 4ppqn:
Timing clock rate of 4ppqn (Pulse Per Quarter Note)
1 pulse of the input timing clock is counted as 1/4 beat (16 minute note).

Changing the settings

- **24ppqn:**
Timing clock rate of 24ppqn (Pulse Per Quarter Note)
24 pulse of the input timing clock is counted as the length of one quarter note.
- **48ppqn:**
Timing clock rate of 48ppqn (Pulse Per Quarter Note)
48 pulse of the input timing clock is counted as the length of one quarter note.
- **Gate:**
Gate input of V-Trigger. Up to 12 V voltage can be input.
A pattern plays while the Gate signal is being input and pauses while no Gate signal is being input. If the Gate signal is input while the sequence pattern is in the stopping state, the sequence pattern playback will start from the first step.
 - When you use the **[CLOCK IN]** terminal as the Gate input, select a terminal other than the **[CLOCK IN]** terminal for a master clock source.

Notes

- **[GATE]** corresponds to V-Trigger only.
- When **[Gate]** is selected, sequence playback/stop cannot be controlled by inputting the Start/Stop signals to the **[CLOCK IN]** terminal.
- For Audio Trigger input, select from **[1step]**, **[1ppqn]**, **[2ppqn]**, or **[4ppqn]**.
- If you change a setting value during sequence playback, the sequence playback stops.

❖ IN Polarity

Setting value: -, +*

Set the polarity of the **[CLOCK IN]** terminal. - is falling and + is rising.

Check the specification of the connected equipment and select an appropriate value.

- -:

Select when timing clock output of the connected equipment triggers in falling of pulse (negative edge trigger).

Input of Negative logic (active low) when **[IN Sync Mode]** is set to **[Gate]**.

- +:

Select when timing clock output of the connected equipment triggers in rising of pulse (positive edge trigger).

Input of Positive logic (active high) when **[IN Sync Mode]** is set to **[Gate]**.

[MIDI IN] setting

You can change the settings of the following terminals.
The default setting is shown with *.

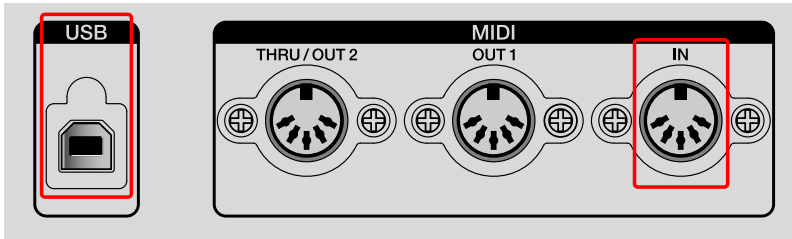

❖ Sync

Setting value: Disable, Receive*

Set the timing clock reception of the **[USB]** terminal and **[MIDI IN]** terminal to Disable/Receive.

❖ Start/Stop

Setting value: Disable, Receive*

Set the Start, Stop, and Continue message reception of the **[USB]** terminal and **[MIDI IN]** terminal to Disable/Receive.

❖ Rec Channel

Setting value: Disable, MIDI Ch.All*, MIDI Ch.1 to MIDI Ch.16, USB Ch.All, USB Ch.1 to USB Ch.16.

Set the terminal and the channel receiving MIDI messages.

- Disable: MIDI messages are not received
- MIDI Ch: Set the channel receiving with the **[MIDI IN]** terminal.
- USB Ch: Set the channel receiving with the **[USB]** terminal.

[MIDI OUT] setting

You can change the settings of the following terminals.
The default setting is shown with *.

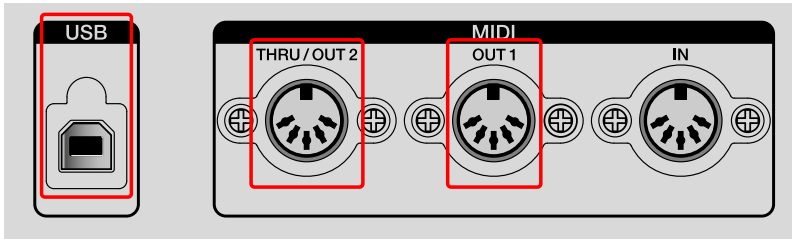

❖ OUT1 Mode

Setting value: MIDI OFF, OUT*, OUT+MIDI IN, OUT+USB IN
Set the **[MIDI OUT1]** terminal.

- MIDI OFF: MIDI messages are not output.
- OUT: MIDI messages of the unit are output.
- OUT+MIDI IN: MIDI messages of the unit and MIDI messages received with the **[MIDI IN]** terminal are merged and output.
- OUT+USB IN: MIDI messages of the unit and MIDI messages received with the **[USB-B]** terminal are merged and output.

❖ OUT1 Sync

Setting value: Disable, Send*

Set sending of the timing clock from the **[MIDI OUT1]** terminal to Disable/Send.

❖ OUT1 Start/Stop

Setting value: Disable, Send*

Set sending of the Start, Stop, and Continue messages from the **[MIDI OUT1]** terminal to Disable/Send.

Changing the settings

❖ **OUT2 Mode**

Setting value: MIDI OFF, OUT, OUT+MIDI IN, OUT+USB IN, THRU (MIDI IN)*, THRU (USB IN)

Set the **[MIDI THRU/OUT2]** terminal.

- **MIDI OFF:** MIDI messages are not output.
- **OUT:** MIDI messages of the unit are output.
- **OUT+MIDI IN:** MIDI messages of the unit and MIDI messages received with the **[MIDI IN]** terminal are merged and output.
- **OUT+USB IN:** MIDI messages of the unit and MIDI messages received with the **[USB]** terminal are merged and output.
- **THRU(MIDI IN):** MIDI messages received with the **[MIDI IN]** terminal are output without any modification.
- **THRU(USB IN):** MIDI messages received with the **[USB-B]** terminal are output without any modification.

❖ **OUT2 Sync**

Setting value: Disable, Send*

Set sending of the timing clock from the **[MIDI THRU/OUT2]** terminal to Disable/Send.

❖ **OUT2 Start/Stop**

Setting value: Disable, Send*

Set sending of the Start, Stop, and Continue messages from the **[MIDI THRU/OUT2]** terminal to Disable/Send.

❖ **USB Sync**

Setting value: Disable, Send*

Set sending of the timing clock from the **[USB-B]** terminal to Disable/Send.

Changing the settings

❖ **USB Start/Stop**

Setting value: Disable, Send*

Set sending of the Start, Stop, and Continue messages from the **[USB-B]** terminal to Disable/Send.

[Randomizer] setting

Set the range of PITCH, GATE, VELOCITY, and control values randomly created by using the Randomizer function.

❖ **Pitch Min**

Setting value:

- When **[Middle C]** of the **[Etc]** setting is set to **[C3]**: C-2 to C3* to G8
- When **[Middle C]** of the **[Etc]** setting is set to **[C4]**: C-1 to C4* to G9
- When **[Middle C]** of the **[Etc]** setting is set to **[C5]**: C0 to C5* to G10

Set the PITCH-minimum value. The upper limit is the setting value of **[Pitch Max]**.

❖ **Pitch Max**

Setting value:

- When **[Middle C]** of the **[Etc]** setting is set to **[C3]**: C-2 to C4* to G8
- When **[Middle C]** of the **[Etc]** setting is set to **[C4]**: C-1 to C5* to G9
- When **[Middle C]** of the **[Etc]** setting is set to **[C5]**: C0 to C6* to G10

Set the PITCH-maximum value. The lower limit is the setting value of **[Pitch Min]**.

❖ **Gate Min**

Setting value: 0.125 Steps* to 16 Steps

Set the Gate-minimum value. The upper limit is the setting value of **[Gate Max]**.

❖ **Gate Max**

Setting value: 0.125 Steps to 1 Step* to 16 Steps

Set the Gate-maximum value. The lower limit is the setting value of **[Gate Min]**.

❖ **Velocity Min**

Setting value: 0* to 60* to 127

Set the Velocity-minimum value. The upper limit is the setting value of **[Velocity Max]**.

❖ **Velocity Max**

Setting value: 0 to 100* to 127

Set the Velocity-maximum value. The lower limit is the setting value of **[Velocity Min]**.

❖ **CC Min**

Setting value: 0* to 127

Set the control-minimum value. The upper limit is the setting value of **[CC Max]**.

❖ **CC Max**

Setting value: 0 to 127*

Set the control- maximum value. The lower limit is the setting value of **[CC Min]**.

[Etc] setting

The default setting is shown with *.

❖ Middle C

Setting value: C3, C4*, C5

Set a pitch name to assign to note number 60.

❖ Auto Power Off

Setting value: Disable, Enable*

Set Auto Power Off to Disable/Enable.

- For details about Auto Power Off, see “Auto power off function” (page 7).

❖ Step Preview

Setting Value: Disable, Enable, Ena(Mute Cur Tr), Ena(Mute All Tr), Ena(Stop/Pause)

Set MIDI message output of the note information of the pads held down by Trigger mode or Interpolation.

- Disable: MIDI messages are not output.
- Enable: MIDI messages are output.
- Ena(Mute Cur Tr): MIDI messages are output; however, at the same time the output of the current track is muted.
- Ena(Mute All Tr): MIDI messages are output; however, at the same time the output of all tracks are muted.
- Ena(Stop/Pause): MIDI messages are output only when a sequence is stopped or paused.

❖ **Reset All Settings**

Select to reset the GLOBAL menu.

When reset, the GLOBAL menu will return to factory default.

- There may be some settings which cannot be reset because they are relevant to projects. In such case, check the respective settings for them.

❖ **Restore Demo**

Select to restore a deleted demo project.

This unit comes with a preset project with demo patterns. This demo project will load automatically. You can delete the loaded demo and restore it using this setting at any time.

❖ **System Info**

Show the current firmware version of the unit.

QUANTIZE settings

QUANTIZE corrects imperfections in trigger timing that occurred during real-time recording using the 16-pads.

Any input delay less than a fourth of the set beat will be quantized to the previous beat.

Any input delay larger than a fourth of the set beat will be quantized to the next beat.

Setting QUANTIZE

- 1 Hold down the **[SHIFT]** button and press the **[TAP]** button.
Quantize settings are shown on the display.
- 2 Turn the rotary selector to select a setting value.
The setting value is determined.

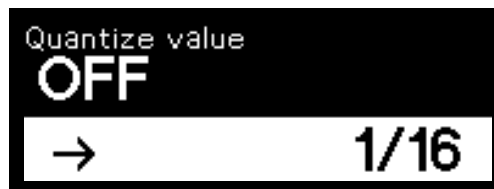

- 3 Press the rotary selector and press the **[BACK]** button, or hold down the **[SHIFT]** button and press the **[TAP]** button.
The display returns to the former state.

QUANTIZE setting

The default setting is shown with *.

❖ **Quantize Range**

Setting value: OFF, 1/32, 1/16*, 1/8

The relationship between the setting value and beat position to be quantized is as follows.

- OFF: Quantize is not set.
- 1/32: Thirty-second note
- 1/16: Sixteenth note
- 1/8: Eighth note

ARPEGGIATOR settings

Note

For operations of the Arpeggiator, refer to “Using the ARPEGGIATOR” (page 91).

Setting the ARPEGGIATOR

- 1 Hold down the **[SHIFT]** button and press the **[ARP]** button.
Arpeggiator settings are shown on the display.
- 2 Turn the rotary selector to select the setting, and then press it.
The setting value of the selected item is highlighted on the display.
The setting value before the change and the setting value after the change are shown on the display.
 - To return to the previous display, press the **[BACK]** button.



- 3 Turn the rotary selector to select the setting value, and then press it.
The setting value is determined.
 - To cancel the setting, press the **[BACK]** button instead of the rotary selector.
- 4 Press the **[BACK]** button, or hold down the **[SHIFT]** button and press the **[ARP]** button.
The display returns to the former state.

ARPEGGIATOR setting

The default setting is shown with *.

❖ Rate

Setting value: 1/2, 1/4, 1/8D, 1/8, 1/8T, 1/16*, 1/16T, 1/32

Rate (speed) for the BPM of Arpeggiator can be set.

❖ Style

Setting value: Up*, Down, Up+Down, Random

This setting is for the Arpeggiator operations when multiple pads are pressed.

- Up: The notes are triggered from the lowest pitch to the higher pitch. This is repeated.
- Down: The notes are triggered from the highest pitch to the lower pitch. This is repeated.
- Up+Down: The notes are triggered from the lowest pitch to the higher pitch, and when it reaches the highest pitch, the notes will trigger from the highest pitch back to the lower pitch repeatedly.
- Random: The notes are triggered randomly.

❖ Range

Setting value: 1 Oct*, 2 Oct, 3 Oct

This setting is the octave range for arpeggio playback.

- 1 Oct: Arpeggios are played with the chord being held.
- 2 Oct: Arpeggios are played with the chord being held and the same chord of one octave higher.
- 3 Oct: Arpeggios are played with the chord being held and the same chord of two octave higher and one octave higher.

❖ Gate Length

Setting value: 1 % to 100 %*

This setting is for note length of arpeggio playback. The length of the sound set by the rate is shown with %.

TRIG PROB (Trigger Probability) settings

Note

For the trigger probability, refer to “TRIG PROB (Trigger Probability)” (page 103).

Setting the Trigger Probability

- 1 Hold down the **[SHIFT]** button and press the **[TRIG PROB]** button.
Trigger probability settings are shown on the display.
- 2 Turn the rotary selector to select the setting value.
The setting value is determined.

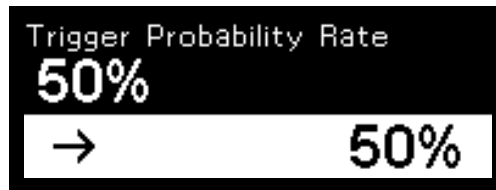

- 3 Press the rotary selector and press the **[BACK]** button, or hold down the **[SHIFT]** button and press the **[TRIG PROB]** button.
The display returns to the former state.

Trigger Probability setting

The default setting is shown with *.

❖ Trigger Probability Rate

Setting value: 10 % to 50 %* to 100 %

When 100 % is selected, all triggers are available, and there is no difference in effect on the trigger probability.

TRACK settings

You can change the settings of the current track.

Setting TRACK

- 1 Hold down the **[SHIFT]** button and press the **[TRACK]** button.
Track settings are shown on the display.
- 2 Turn the rotary selector to select the setting, and then press it.
The setting value of the selected item is highlighted on the display.
The setting value before change and the setting value after change are shown on the display.
 - To return to the previous display, press the **[BACK]** button.



- 3 Turn the rotary selector to select the setting value, and then press it.
The setting value is determined.
 - To cancel the setting, press the **[BACK]** button instead of the rotary selector.
- 4 Press the **[BACK]** button, or hold down the **[SHIFT]** button and press the **[TRACK]** button.
The display returns to the former state.

TRACK SETTING

The default setting is shown with *.

❖ Track Name

Set the Track Name. The Track Name set here is shown on the display when the 16-pads are in Track mode.

- When the name of the track is set, the track name is shown on the display in Track mode. When creating a new project, it is set from Track 01 to Track 16.
- Press the **[▶]/[◀]** button to move the cursor and turn the rotary selector to select the character.
- Alphanumeric characters, symbols or blanks are available.
- To delete the character at the cursor, hold down the **[SHIFT]** button and press the **[BACK]** button.
- To insert a blank before the cursor, hold down the **[SHIFT]** button and press the rotary selector.

❖ Mono/Poly

Setting value: Poly*, Mono

Set the monophonic (Mono) or polyphonic (Poly) for the track.

- Poly: Up to 8 notes for each step can be set.
- Mono: Only Note 1 is available for each step.

❖ Track Speed

Setting value: x0.25, x0.5, x1.0*, x1.5, x2.0

You can set the playback speed of the track. The current track is played at the magnification of the setting value according to the playback speed by the set BPM.

















Changing the settings

❖ Track Color

Setting value: #01 to #16

Set the track colors of the 16-pads.

The correspondence between the setting value and Track Color is as follows.

#01		#02		#03		#04	
#05		#06		#07		#08	
#09		#10		#11		#12	
#13		#14		#15		#16	

HARMONIZER settings

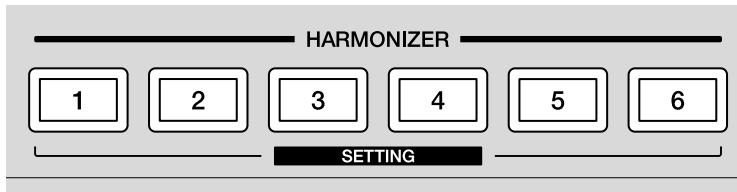

1 through 6 of the **[HARMONIZER]** buttons can be set with selected chord types (page 149).

Note

For Harmonizer, refer to “HARMONIZER” (page 71).

- 1 Hold down the **[SHIFT]** button and press one of the **[HARMONIZER]** buttons.

The display shows the chord type being selected.

The chord of the **[HARMONIZER]** button is shown on the 16-pads.

- The chord is shown with white lit on the 16-pads.
- The note on the pad increases by a semitone at a time from the lower-left root note towards the top right corner in a lateral direction.

- 2 Turn the rotary selector to select a chord type.

The chord name before the change and the chord name after the change are shown on the display.

(1) Chord before the change, (2) Chord after the change

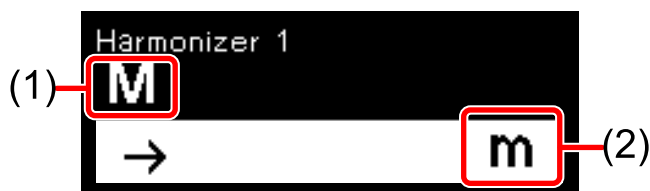

- For the chord type, refer to “Setting value:” (page 149).

Changing the settings

- 3 Press the **[BACK]** button, or hold down the **[SHIFT]** button and press the **[HARMONIZER]** button.

The display returns to the former state.

Setting value:

The contents in the parentheses is not shown on the display.

- M (major)
- m (minor)
- 7 (seventh)
- M7 (major seventh)
- m7 (minor seventh)
- mM 7 (minor major seventh)
- 6 (sixth)
- m6 (minor sixth)
- 9 (ninth)
- M9 (major ninth)
- m9 (minor ninth)
- 69 (sixth ninth)
- m69 (minor 69)
- sus4 (suspended fourth)
- 7sus4 (seventh suspended fourth)
- dim (diminish)
- aug (augment)
- aug7 (augment 7)
- add9 (add ninth)
- 7+5 (seventh sharp 5)
- 7-5 (seventh flat 5)
- m7-5 (minor seventh flat 5)
- 7 (# 9) (seventh sharp 9)
- 7-9 (seventh flat 9)

Customizing the [HARMONIZER] button

The chord selected from the setting value (page 149) can be customized and set as an original user chord.

- 1 Hold down the **[SHIFT]** button, and press the **[HARMONIZER]** button you want to customize.
The display shows the chord being selected.
The chord of the **[HARMONIZER]** button is lit in white on the 16-pads.
- 2 Turn the rotary selector to select a chord to be customized.
The chord name before the change and the chord name after the change are shown on the display.
- 3 Press the 16-pads to add note (pad lights up) or delete note (pad dims).
[USER] is shown in the chord section of the display.
 - The note of the pad increases in a semitone at a time from the lower-left root note towards the top right corner in a lateral direction.
 - Up to 5 chords can be set.
- 4 Press the **[BACK]** button, or hold down the **[SHIFT]** button and press the **[HARMONIZER]** button.
Harmonizer setting mode is canceled and the display returns to the former state.

FIXED LENGTH setting

Note

For Fixed Length, refer to “FIXED LENGTH” (page 79).

Setting FIXED LENGTH

- 1 Hold down the **[SHIFT]** button and press the **[FIXED LENGTH]** button.
Fixed Length settings are shown on the display.
- 2 Turn the rotary selector to select the setting value.
The setting value is determined.



- 3 Press the rotary selector and press the **[BACK]** button, or hold down the **[SHIFT]** button and press the **[FIXED LENGTH]** button.
The display returns to the former state.

Fixed Length setting

The default setting is shown with *.

❖ Fixed Length

Setting value: 0.25 beat to 4 beat* to 16 beat

1 beat is equivalent to quarter note length. It is the length of one beat indicator on the display.

Connecting to external equipment

Connecting the unit to an external MIDI device or a PC/Mac to play

By connecting the **[MIDI OUT1]** terminal, **[MIDI THRU/OUT2]** terminal, or **[USB-B]** terminal of this unit to the MIDI terminal of an external MIDI device or the USB terminal of a PC/Mac, you can perform the following:

- Performance using sequence information recorded in each track of the unit
- Real-time phrase arrangement by operating the step edit section or phrase arrangement section
- Synchronized performance with an external sequencer or DAW software

The BPM of performance using sequence information and synchronized performance with an external MIDI device correspond to the BPM of the clock source set on the unit.

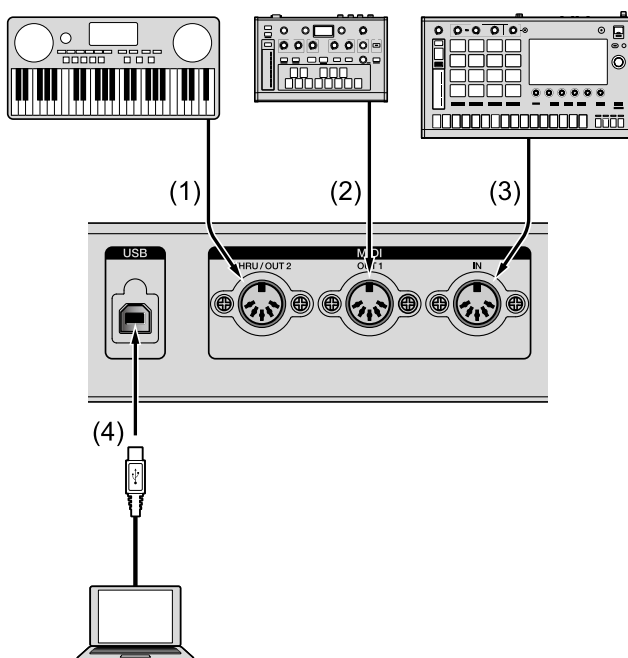

[MIDI THRU/OUT2] terminal (1), [MIDI OUT1] terminal (2)

Connect a MIDI cable to the MIDI IN terminal of the synthesizer, sound module, etc.

- For the terminal and settings of the related item, see the following.
 - “[MIDI OUT] setting” (page 133)
 - “[Sync Common] setting” (page 124)

❖ [MIDI OUT1] terminal or [MIDI THRU/OUT2] terminal set to [OUT]

- Sequence information recorded in each track of the unit, operating information on the unit, and BPM information (timing clock) are sent to external MIDI devices as MIDI messages.
- When pressing the [▶] (play) button on the unit or receiving the Start signals from external devices connected to the unit, sequence information recorded in each track of the unit is sent to an external MIDI device as performance information in accordance with the BPM or MIDI channel set by this unit.
- You can modify performance information in real time by operating the phrase arrangement section or step edit section.
- In Scale mode, you can perform with an external MIDI device by operating the 16-pads. Also, you can control the sequence playback operation of an external MIDI device connected to the unit by sending MIDI messages such as the Start, Stop, and Continue messages.

Notes

- Set the MIDI channel of the output destination port of the track. (Refer to “Selecting an output destination for the current track” (page 32).)
- Set the MIDI receive channel of the receiving device correctly.

Connecting to external equipment

❖ [MIDI THRU/OUT2] terminal set to [THRU (MIDI IN)]/[THRU (USB IN)]

Send the MIDI messages received with the [MIDI IN] terminal or the [USB-B] terminal to an external MIDI device connected to the [MIDI THRU/OUT2] terminal without changing it when [OUT2 Mode] (page 134) of the [MIDI OUT] setting in the GLOBAL menu is set to [THRU (MIDI IN)] or [THRU (USB IN)].

Note

Set the MIDI transmit channel of the transmitting device and the MIDI receive channel of the receiving device correctly.

❖ [MIDI OUT1] terminal / [MIDI THRU/OUT2] terminal set to [OUT+MIDI IN] or [OUT+USB IN]

When you set [OUT1 Mode] of the [MIDI OUT] setting in the GLOBAL menu to [OUT+MIDI IN] or [OUT+USB IN], the unit merges the MIDI messages and the MIDI messages received with the [MIDI IN] terminal or the [USB-B] terminal and outputs it.

Note

Set the MIDI receive channel of the receiving device correctly according to the application.

[MIDI IN] terminal (3)

Connect the MIDI OUT terminal of an external sequencer, etc. to the [MIDI IN] input terminal using a MIDI cable.

- You can control the sequence playback operation on the unit from an external MIDI device by sending MIDI messages such as the Start, Stop, and Continue messages to the [MIDI IN] terminal.
- For the terminal and settings of the related, refer to the following.
 - “[MIDI IN] setting” (page 132)
 - “[Sync Common] setting” (page 124)

[USB-B] terminal (4)

Connect the PC/Mac. Refer to “Connections” (page 18).

- Between DAW software on a PC/Mac and the unit, sequence information, operating information, and BPM information (timing clock) are sent and received as MIDI messages.
- When you press the play button on the unit, the unit sends sequence information recorded in each track to DAW software as performance information in accordance with the BPM or MIDI channel.
- You can modify the performance information to send in real time by operating the phrase arrangement section or step edit section.
- In Scale mode, you can send playback information to DAW software by operating the 16-pads. Also, you can control the sequence playback operation on the unit by sending MIDI messages such as the Start, Stop, and Continue messages from DAW software. Furthermore, you can control the sequence playback operation of DAW software by sending these MIDI messages from the unit.
- For the terminal and settings of the related item, refer to the following.
 - “[MIDI IN] setting” (page 132)
 - “[MIDI OUT] setting” (page 133)
 - “[Sync Common] setting” (page 124)

Note

By using a dedicated application or updater, you can send and receive standard MIDI files and project data via the **[USB-B]** terminal or update the firmware on the unit to the latest version.

Synchronizing the unit to external MIDI devices or a PC/Mac

You can perform synchronized playback with external MIDI devices such as external sequencers, DAW software, etc. by using real-time MIDI messages such as the timing clock, Start, Stop, and Continue.

When using the unit as a master device

By setting **[Sync Source]** of **[Sync Common]** setting in the GLOBAL menu to **[Internal]**, you can send the timing clock from the **[MIDI OUT1]** terminal, **[MIDI THRU/OUT2]** terminal set to **[OUT]** / **[OUT+MIDI IN]** / **[OUT+USB IN]**, or **[USB-B]** terminal in accordance with the BPM of the unit.

Set **[Master Clock Mode]** of **[Sync Common]** setting in the GLOBAL menu according to the external MIDI device connected to the unit.

By setting the external MIDI device as a slave device, you can play a sequence at the same BPM as the one of the unit and control playing back and stopping of the synchronized playing by operating the unit or the external MIDI device connected to the **[MIDI IN]** terminal or **[USB-B]** terminal on the unit.

When using the unit as a slave device

By setting **[Sync Source]** of **[Sync Common]** setting in the GLOBAL menu to the connecting terminal of an external master device and sending the timing clock to the unit, you can use the unit as a slave device.

By setting the unit as a slave device, you can play a sequence at the same BPM as an external master device and control playing back and stopping of the synchronized playing by operating the unit or the external device connected to the **[MIDI IN]** terminal, **[USB-B]** terminal, or the timing clock input terminal set in **[Sync Source]** on the unit. The received timing clock can be converted and output from the following terminals.

- **[DIN SYNC OUT1]** terminal
- **[DIN SYNC IN/OUT2]** terminal
- **[CLOCK OUT]** terminal

For the settings of the timing clock rate from each terminal, refer to the **[DIN SYNC]** setting (page 125) or **[CLOCK]** setting (page 128) in the GLOBAL menu.

Notes

- If you set **[Sync Source]** to a state other than **[DIN MIDI]** or **[USB MIDI]**, refer to “Synchronizing the unit and an external DIN SYNC compatible device to play” (page 160) and “Synchronizing the unit with an external CLOCK compatible device to play” (page 165).
- Depending on the external device to be connected, the BPM displayed on the unit and the external device may be different.

Connecting the unit to an external CV/GATE compatible device to play

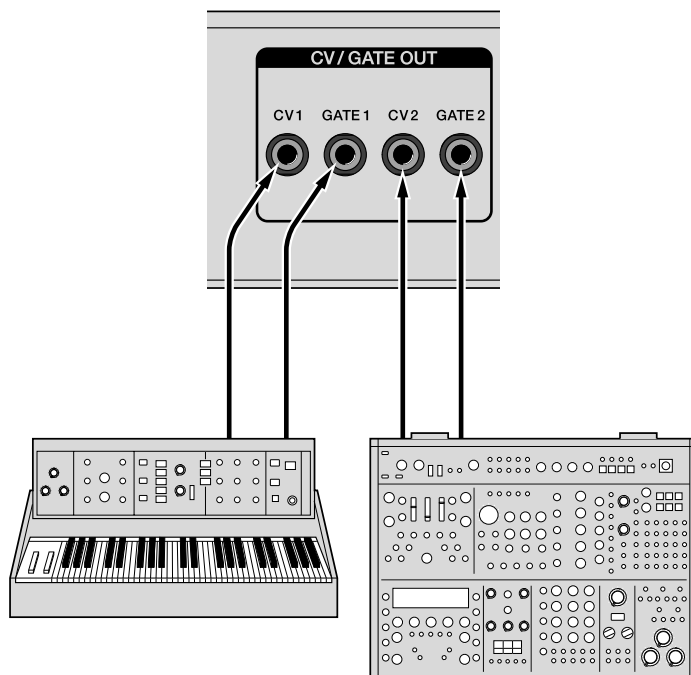

Connect a synthesizer, sound module, etc. that are compatible with CV/GATE input. Use a monaural mini-jack cable for connection. The unit outputs sequence information of a track whose output port is set to **[CV/GATE1]** or **[CV/GATE2]** in Track mode as CV signals or GATE signals.

CV signals correspond to V/Oct or Hz/V and GATE signals correspond to V-Trigger or S-Trigger.

You can set the output signals from the **[CV OUT1]** terminal or **[CV OUT2]** terminal through **[CV1 Range]**, **[GATE1 Mode]**, **[CV2 Range]**, and **[GATE2 Mode]** of **[CV]** setting and **[GATE]** setting in the GLOBAL menu.

Connecting to external equipment

The unit also supports the CV/GATE conversion function that converts the note information received from the **[MIDI IN]** terminal or **[USB-B]** terminal to CV signals or GATE signals to output.

You can set the MIDI channel input and the CV/GATE output for the CV/GATE conversion function through **[CV/GATE1 From]** and **[CV/GATE2 From]** of **[CV/GATE OUT]** setting in the GLOBAL menu.

Settings and operations

- Set the track output port to **[CV/GATE1]** or **[CV/GATE2]**.
- Set **[GATE]** setting (page 122) in the GLOBAL menu correctly according to the GATE input of the connected device.
- Set **[CV]** setting (page 119) in the GLOBAL menu correctly according to the CV input of the connected device.
 - **[CV Reference Note]** can be set only when **[V/Oct]** is selected for **[CV Range]**. For details, refer to “[CV] setting” (page 119).
- For settings other than the above, refer to the following.
 - “[CV/GATE OUT] setting” (page 118)

Note

When using the CV/GATE conversion function, set the MIDI channel of **[CV/GATE OUT]** setting in the GLOBAL menu and the MIDI channel of the transmitting device correctly.

Synchronizing the unit and an external DIN SYNC compatible device to play

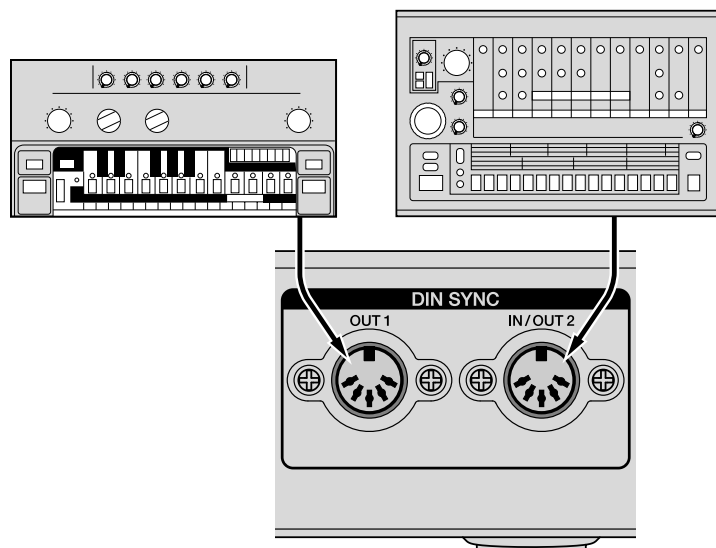

You can play the unit in sync with the connected device by connecting the **[DIN SYNC OUT1]** terminal or **[DIN SYNC IN/OUT2]** terminal on the unit to the DIN SYNC IN terminal or DIN SYNC OUT terminal of a DIN SYNC-compatible sequencer or drum machine.

The DIN SYNC terminal can send and receive not only BPM information as the timing clock but also control signals for playing and pausing the synchronized performance by using signals such as Start, Stop, and Continue.

Connecting

- Connect the **[DIN SYNC OUT1]** terminal or **[DIN SYNC IN/OUT2]** terminal set to **[OUT]** of this unit to the DIN SYNC IN terminal of the connected device.
- Connect the **[DIN SYNC IN/OUT2]** terminal set to **[IN]** of this unit to the DIN SYNC OUT terminal of the connected device.

Connecting to external equipment

- Select **[IN]/[OUT]** setting of the **[DIN SYNC IN/OUT2]** terminal through **[OUT2 Mode]** of the **[DIN SYNC]** setting in the GLOBAL menu. The factory default setting of the **[DIN SYNC IN/OUT2]** terminal is **[IN]**.
- Use a MIDI cable (5PIN DIN cable) compatible with DIN SYNC for this connection.

Notes

- For the MIDI cable, use the cable with the 1 PIN and 3 PIN.
- When using a mini-jack conversion cable, use a conversion DIN SYNC-compatible cable with 1 PIN-RING and 3 PIN-TIP connections, not a conversion cable for MIDI.

The pin arrangement of the **[DIN SYNC OUT1]** terminal and **[DIN SYNC IN/OUT2]** terminal is as follows. (It is not compatible with **[MIDI]** terminals.)

(1) Start/Stop, (2) GND, (3) Clock, (4) Reset Start, (5) Continue Start

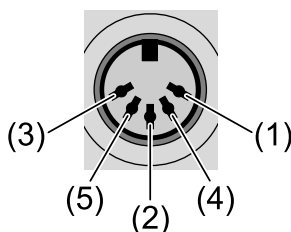

- (For Reference) The pin arrangement of the MIDI terminal is as follows.
(1) Non-connection, (2) GND, (3) Non-connection, (4) VTX/VRX, (5) Signal

Settings and operations

- Set the **[OUT1 Sync Mode]** or **[OUT2 Sync Mode]** of **[DIN SYNC]** setting in the GLOBAL menu to **[Sync24]** or **[Sync48]** according to the timing clock rate of the device connected to each of the terminals.
- When connecting the DIN SYNC OUT terminal of the connected device to the **[DIN SYNC IN/OUT2]** terminal set to **[IN]** to use this unit as the slave device, set **[Sync Source]** of the **[Sync Common]** setting in the GLOBAL menu to **[DIN SYNC]** and set **[OUT2 Sync Mode]** of **[DIN SYNC]** setting correctly according to the timing clock rate of the connected device.
- The operations by Reset Start and Continue Start operations may differ depending on the connected device. Check the manual of the connected device and set **[OUT1 Cont/Rst Start]** or **[OUT2 Cont/Rst Start]** of the **[DIN SYNC]** setting correctly in accordance with the Reset Start and Continue Start operations of the unit.

When connecting to a device that does not support the Reset Start and Continue Start specifications of the unit, set it to avoid malfunctions on the unit or the connected device caused by external noise.

Signal and sequencer operations

This unit synchronizes with the timing when the Start/Stop signals instruct the sequence performance, and sends Continue Start or Reset Start signal from the **[DIN SYNC OUT1]** terminal or **[DIN SYNC IN/OUT2]** terminal set to **[OUT]** at the timing shown below.

If the Continue Start or Reset Start signal is received at the **[DIN SYNC IN/OUT2]** terminal set to **[IN]** at the timing shown below, the sequencer operation is restarted from the stop position or played from the first step.

Connecting to external equipment

Playback from the stop state

- (1) Start/Stop signal, (2) Continue Start signal, (3) Reset Start signal, (4) Playback starts

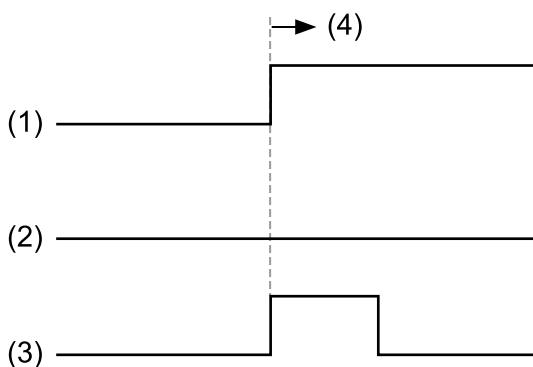

Playback from the pause state

- (1) Start/Stop signal, (2) Continue Start signal, (3) Reset Start signal, (4) Playback starts

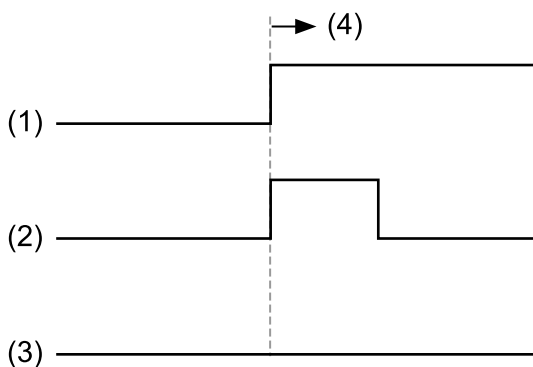

If neither Reset Start signal or Continue Start signal is input, the sequencer playback will always be Reset Start from the stop state.

Connecting to external equipment

Notes

- Depending on the external device to be connected, the BPM displayed on the unit and the external device may be different.
- When setting the **[CLOCK IN]** terminal of the unit as the master clock source of the low timing clock (1ppqn, 2ppqn, 4ppqn) and slave operation of the unit, DIN SYNC compatible devices connected to the **[DIN SYNC OUT1]** terminal or the **[DIN SYNC IN/OUT2]** terminal set to **[OUT]** may be out of synchronization.

For synchronized playback with DIN SYNC compatible devices, we recommend not using timing clock rate conversion from the low timing clock, but using a master clock source of 24ppqn (Sync24) or 48ppqn (Sync48).

Synchronizing the unit with an external CLOCK compatible device to play

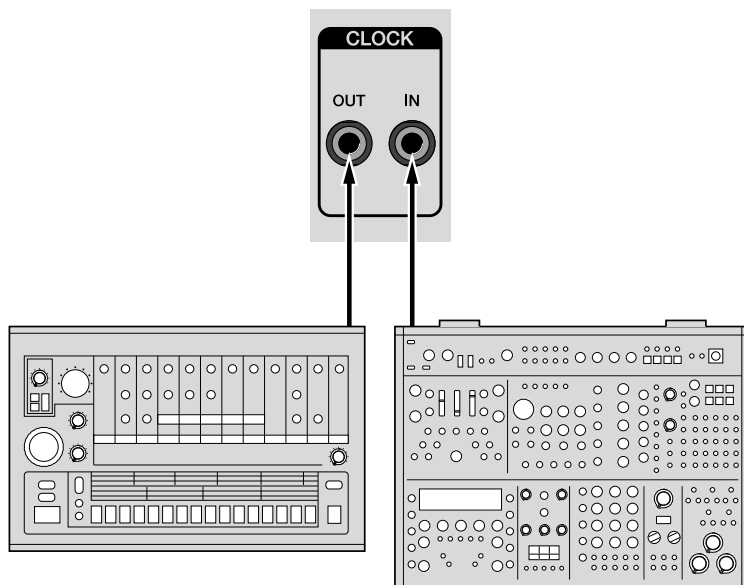

You can play the unit in sync with the connected device by connecting the **[CLOCK OUT]** terminal or **[CLOCK IN]** terminal of the unit to the CLOCK IN terminal or CLOCK OUT terminal of analogue signal-compatible sequencer or drum machine, etc.

The CLOCK terminal can send and receive not only BPM information as the timing clock but also control signals for playing and pausing the synchronized performance by using the Start/Stop command signals.

When using the unit as a master device, you may control the pause operation with the timing clock from the **[CLOCK OUT]** terminal on the device connected to the **[CLOCK OUT]** terminal of the unit by setting **[Master Clock Mode]** of **[Sync Common]** setting in the GLOBAL menu to **[Disable]**.

Connecting to external equipment

Also, the **[CLOCK IN]** terminal supports audio-click (metronome) input, audio-trigger control that plays a sequence of the unit in one step increments, and GATE control that plays sequence information only while control signals are being input.

Connecting

- Connect the **[CLOCK OUT]** terminal of this unit to the CLOCK IN terminal of the connected device.
- Connect the **[CLOCK IN]** terminal of this unit to the CLOCK OUT terminal of the connected device.
- Use a stereo mini-jack cable for this connection.

The signals shown below are assigned to the pins of a stereo mini-jack cable connected to the **[CLOCK IN]** terminal or **[CLOCK OUT]** terminal.

(1) Sleeve: GND, (2) Ring: Start/Stop, (3) Tip: clock

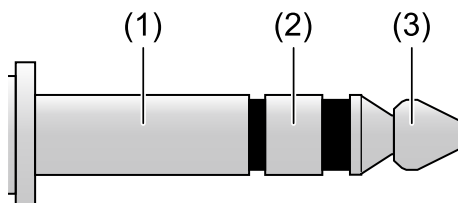

- By connecting Ring and Tip to PIN1 (Start/Stop) and PIN3 (Clock) of the **[DIN SYNC]** terminal and setting **[OUT Sync Mode]** or **[IN Sync Mode]** of the **[CLOCK]** setting in the GLOBAL menu to **[24ppqn]** or **[48ppqn]**, you can connect the CLOCK terminal on this unit to the DIN SYNC terminal of a DIN SYNC-compatible device.

Connecting to external equipment

Notes

- When using a 5 PIN DIN conversion cable, use a conversion cable that is a 1 PIN-RING, 3 PIN-TIP connection instead of a MIDI conversion cable. The stereo mini-jack 5 PIN DIN conversion cable for MIDI cannot be used for SYNC conversion because PIN 1 and PIN 3 are not connected.
- When triggering the **[CLOCK IN]** terminal with an audio signal without using the Start/Stop signal, use a monaural mini-jack to prevent noise in the Start/Stop signal input pin.
- When using the audio signal as a trigger signal, input an appropriate volume of signals containing keen attack/decay, such as pulse signals or click sound.
- Input audio signals at the level of 2 V or more.
- When setting **[IN Sync Mode]** of the **[CLOCK]** setting in the GLOBAL menu to **[Gate]** to Gate control the unit with the **[CLOCK IN]** terminal, input the Gate signal of V-Trigger into the **[CLOCK IN]** terminal.

Also, sequence playback/stop cannot be controlled by inputting the Start/Stop signals to the **[CLOCK IN]** terminal.

Set **[Sync Source]** of the **[Sync Common]** setting to an other than **[CLOCK]**. If it is set to **[CLOCK]**, the sequence playback will never be performed even though the GATE signal is input.

Settings and operations

- Select the setting of **[OUT Sync Mode]** and **[In Sync Mode]** of **[CLOCK]** setting in the GLOBAL menu according to the timing clock rate of the connected device.
- Select the **[Polarity]** setting of **[CLOCK]** setting in the GLOBAL menu to **[+]** or **[-]** according to the polarity of the connected device.
- When using the unit as a slave device by connecting the CLOCK OUT terminal of the connected device to the **[CLOCK IN]** terminal of the unit, set **[Sync Source]** of **[Sync Common]** setting in the GLOBAL menu to **[CLOCK]** and set **[IN Sync Mode]** of **[CLOCK]** setting correctly according to the timing clock rate of the connected device.
- For other settings, refer to the following.
 - “[Sync Common] setting” (page 124)
 - “[CLOCK] setting” (page 128)

Note

Depending on the external device to be connected, the BPM displayed on the unit and the external device may be different.

Signal conversion function

The unit is provided with the following signal conversion function.

- Timing clock rate conversion
- CV/GATE conversion

Timing clock rate conversion

Convert the timing clock received by the input terminal set on **[Sync Source]** of **[Sync Common]** setting in the GLOBAL menu to a different timing clock format and output from each of the output terminals (USB, MIDI, DIN SYNC, and CLOCK).

Timing clock rate settable in Sync mode of each of the input and output terminals (USB, MIDI, DIN SYNC, and CLOCK) are as follows.

(The default setting is shown with *.)

- USB-B: 24 ppqn (Fixed)
- MIDI IN: 24 ppqn (Fixed)
- MIDI OUT1: 24 ppqn (Fixed)
- MIDI THRU/OUT2: 24 ppqn (Fixed)
- DIN SYNC OUT1: **[24ppqn]*, [48ppqn]**
- DIN SYNC IN/OUT2: **[24ppqn]*, [48ppqn]**
- CLOCK IN: **[1ppqn], [2ppqn], [4ppqn], [24ppqn]*, [48ppqn]**
- CLOCK OUT: **[1ppqn], [2ppqn], [4ppqn], [24ppqn]*, [48ppqn]**

For the timing clock rate settings of DIN SYNC and CLOCK, refer to the following.

- “[DIN SYNC] setting” (page 125)
- “[CLOCK] setting” (page 128)

Connecting to external equipment

Notes

- When setting the **[MIDI THRU/OUT2]** terminal to **[THRU (MIDI IN)]** or **[THRU (USB IN)]**, the same timing clock as the one of the **[MIDI IN]** terminal or the **[USB-B]** terminal will output from the **[MIDI THRU/OUT2]** terminal.
- When converting from low timing clock to high timing clock (e.g. when converting 1ppqn input to 24ppqn output), the timing clock may not be output until the unit detects the BPM in the timing clock input.
- Depending on the external device to be connected, the BPM displayed on the unit and the external device may be different.
- When setting the **[CLOCK IN]** terminal of the unit as the master clock source of the low timing clock (1ppqn, 2ppqn, 4ppqn) and slave operation of the unit, DIN SYNC compatible devices connected to the **[DIN SYNC OUT1]** terminal or the **[DIN SYNC IN/OUT2]** terminal set to **[OUT]** may be out of synchronization.
For synchronized playback with DIN SYNC compatible devices, we recommend not using timing clock rate conversion from the low timing clock, but using a master clock source of 24ppqn (Sync24) or 48ppqn (Sync48).

CV/GATE conversion

Convert the note information received from the **[USB-B]** or **[MIDI IN]** terminal to the CV or Gate signals and output from the **[CV OUT1]**, **[GATE OUT1]**, **[CV OUT2]**, or **[GATE OUT2]** terminal.

Refer to “Connecting the unit to an external CV/GATE compatible device to play” (page 158) on the setting of MIDI channel for CV/GATE conversion.

Additional information

Troubleshooting

If you think that there is something wrong with this unit, check the items below. Also access the Pioneer DJ site and check **[FAQ]** for the **[SQUID]** in the **[FAQ]** page.

pioneerdj.com/

Sometimes, the problem may lie in another component. Inspect the other components and electrical appliances being used. Also, refer to their manuals and FAQ if necessary. If the problem cannot be rectified, ask your nearest Pioneer DJ authorized service center or your dealer to carry out repair work.

- This unit may not operate properly because of static electricity or other external influences. In this case, proper operation may be restored by disconnecting the USB cable and the power cord, and then connecting them back in.
- When operation of an external device connected to the unit or the unit itself becomes unstable, execute **[Reset All Settings]** (page 139) of **[Etc]** setting in the GLOBAL menu, initialize the GLOBAL menu, and then reset the related items. There are some items that cannot be initialized, such as the items that are linked with a project. For those items, check each setting individually.

Power

- ❖ **The power of the unit does not turn on. / No indicators light up.**
 - See “Connections” (page 18).
 - Check the **[⏻]** button on the rear panel (page 16).

❖ **When using USB-bus power, the power of the unit does not turn on. / All indicators do not light up.**

- See “Connections” (page 18).
- Check the [⏻] button on the rear panel (page 16).
- Start the PC/Mac to be used for the USB power supply.

❖ **The unit turns off automatically.**

- See “Auto power off function” (page 7).

❖ **Operation becomes unstable when using USB-bus power.**

- See “Connections” (page 18).

Connection and setting

❖ **Equipment connected to the [MIDI OUT1] or [MIDI THRU/OUT2] terminal set to [OUT] does not work.**

- See “Connecting the unit to an external MIDI device or a PC/Mac to play” (page 152).
- Set the MIDI channel of the output destination port of the track. Also, check that the MIDI receive channel of the connected device is set correctly.

❖ **Equipment connected to the [MIDI THRU/OUT2] terminal set to [THRU (MIDI IN)]/[THRU (USB IN)] does not work.**

- See “Connecting the unit to an external MIDI device or a PC/Mac to play” (page 152).
- Check that the MIDI transmit channel of the transmitting device and the MIDI receive channel of the receiving device are set correctly.

- ❖ **The unit cannot be controlled from equipment connected to the [MIDI IN] terminal.**
 - See “Connecting the unit to an external MIDI device or a PC/Mac to play” (page 152).
 - Check that the MIDI transmit channel of the transmitting device and the MIDI receive channel of the receiving device are set correctly.

- ❖ **Equipment connected to the [DIN SYNC OUT1] or [DIN SYNC OUT2] terminal set to [OUT] does not work./The unit cannot be controlled from equipment connected to the [DIN SYNC IN/ OUT2] terminal set to [IN].**
 - See “Synchronizing the unit and an external DIN SYNC compatible device to play” (page 160).

- ❖ **Equipment connected to the [CLOCK OUT] terminal does not work / The unit cannot be controlled from equipment connected to the [CLOCK IN] terminal.**
 - See “Synchronizing the unit with an external CLOCK compatible device to play” (page 165).

- ❖ **The [CLOCK IN] terminal cannot be used for [Gate] settings.**
 - Check that the output setting of the equipment connected to the [CLOCK IN] terminal is set to V-Trigger. Only the + polarity setting can be used.
 - Check that the output voltage signal of the connected device is 2 V or more.
 - Set [Sync Source] of [Sync Common] setting in the GLOBAL menu correctly.

- ❖ **The [CLOCK IN] terminal cannot be triggered with audio signals.**
 - Check the volume on the connected equipment.

Additional information

- To use the audio signal as a trigger signal, input sound with sufficiently high volume that has sharp attack/decay, like pulse signal and click sound.
- To control the unit by the audio signal, see **[IN Sync Mode]** (page 129) of **[CLOCK]** setting in the GLOBAL menu.
- ❖ **The slave device (the unit) cannot be controlled from a master device (equipment connected to the unit).**
- Check that the **[USB-B]**, **[MIDI IN]**, **[CLOCK IN]**, or **[DIN SYNC IN/OUT2]** terminal where **[OUT2 Mode]** (page 126) of **[DIN Sync]** setting in the GLOBAL menu is set to **[IN]** is connected correctly to a master-clock transmitter.
- Set **[Sync Source]** (page 124) of the **[Sync Common]** setting in the GLOBAL menu correctly.
Set **[IN Sync Mode]** (page 129) of **[CLOCK]** setting correctly in accordance with the connected device when **[CLOCK]** is set.
Set **[OUT2 Sync Mode]** (page 126) of **[DIN Sync]** setting correctly in accordance with the connected device when **[DIN SYNC]** is set.
- ❖ **Equipment connected to the [CV OUT1], [CV OUT2], [GATE OUT1], or [GATE OUT2] terminal does not work.**
- See “Connecting the unit to an external CV/GATE compatible device to play” (page 158).
- ❖ **The device connected to the [CV OUT1] or [CV OUT2] terminal does not produce notes with correct pitch.**
- Check if the Coarse and Fine are set correctly on the connected device. Since CV is a pitch control signal by analog voltage, it may not be possible for the receiving device to produce note with the correct pitch depending on the temperature. In that case, adjust the pitch with the Fine setting of the receiving device.

- ❖ **[CV OUT1], [CV OUT2], [GATE OUT1], or [GATE OUT2] terminal does not work even with MIDI input.**
 - See “Connecting the unit to an external CV/GATE compatible device to play” (page 158).
 - Check that the MIDI transmit channel of the transmitting device and the input MIDI channel of **[CV/GATE OUT]** setting (page 118) are set correctly.
- ❖ **The PC/Mac (DAW software, etc.) cannot communicate with the unit.**
 - See “Connections” (page 18).
 - See the manual or FAQ of the connected PC/Mac (DAW software, etc.) to check that the PC/Mac recognizes the unit.

Others

- ❖ **The indicator lights up dimly.**
 - See “Special notes when using USB-bus power” (page 18).
 - Set **[Display]** and **[Buttons Full Lit]**, **[Pads Full Lit]**, and **[Pads Dim Lit]** (page 116) in the GLOBAL menu to appropriate brightness.

About trademarks and registered trademarks

- Pioneer DJ is a trademark of PIONEER CORPORATION, and is used under license.
- The names of companies and products mentioned herein are the trademarks of their respective owners.

Specifications

AC adapter

Power	AC 100 V to 240 V, 50 Hz/60 Hz
Rated current.....	0.4 A
Rated output	DC 5 V, 2 A

General - Main Unit

Power consumption

DC IN	DC 5 V, 1 200 mA
-------------	------------------

Main unit weight.....	1.9 kg (4.2 lbs.)
-----------------------	-------------------

Max. dimensions....	374.8 mm (width) × 72.1 mm (height) × 223.9 mm (depth) (14.8 in. (width) × 2.8 in. (height) × 8.8 in. (depth))
---------------------	--

Tolerable operating temperature....	+5 °C to +35 °C (+41 °F to +95 °F)
-------------------------------------	------------------------------------

Tolerable operating humidity.....	5 % to 85 % (no condensation)
-----------------------------------	-------------------------------

Input/output terminals

DIN SYNC IN/OUT2 input/output terminal

5-pin DIN	1 set
-----------------	-------

DIN SYNC OUT1 output terminal

5-pin DIN	1 set
-----------------	-------

CLOCK IN input terminal

1/8" stereo mini jack	1 set
-----------------------------	-------

CLOCK OUT output terminal

1/8" stereo mini jack	1 set
-----------------------------	-------

GATE OUT output terminal

1/8" mono mini jack	2 sets
---------------------------	--------

CV OUT output terminal

1/8" mono mini jack	2 sets
---------------------------	--------

MIDI IN input terminal

5-pin DIN	1 set
-----------------	-------

Additional information

MIDI OUT1 output terminal

5-pin DIN 1 set

MIDI THRU/OUT2 output terminal

5-pin DIN 1 set

USB terminal

B type 1 set

- The specifications and design of this product are subject to change without notice.

© 2019 Pioneer DJ Corporation.

All rights reserved.

<DRI1560-A>